

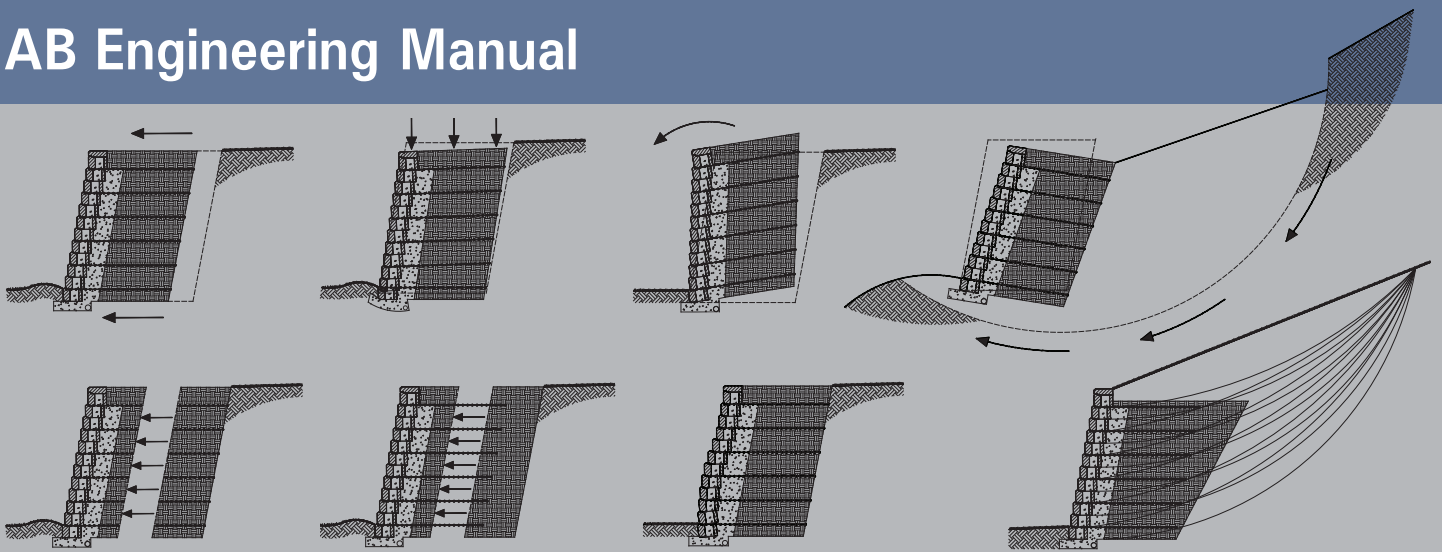

allanblock.com

AB Engineering Manual



Allan Block® Retaining Walls

allanblock.com



**ALLAN
BLOCK**

allanblock.com

This manual presents the techniques used by Allan Block in our engineering practice to design retaining walls. It is not intended as a textbook of soil mechanics or geotechnical engineering. The methods we use are based on time tested soil mechanics and the principles of dry stacked block which have existed for thousands of years. Manufactured segmental retaining walls have evolved over the course of over 25 years and continue to evolve as our knowledge and experience grows.

The intended users of this manual are practicing engineers. When writing it, we assumed that the reader would already be familiar with the basic principles of statics and soil mechanics. We encourage others to contact a qualified engineer for help with the design of geogrid reinforced retaining walls. Design calculations alone cannot ensure that designs will yield a safe and properly functioning structure. We recommend that the designer refer to the "Best Practices for SRW Design" for design details and standards that have been proven to meld design theory with field experience. Please take note of the chapter on Internal Compound Stability (ICS) as a substantially better analytic protocol. When ICS is incorporated into a design review you will more accurately define the minimum required grid lengths and maximum grid spacing. Internal and External Calculations by themselves may not accurately evaluate potential failure modes which run through the retained soil, reinforced soil mass and block facing.

The example problems in this manual are based on walls constructed with Allan Block Retaining Wall System's AB Stones. The AB Stones provide a nominal setback of twelve degrees from vertical. We believe that a twelve degree setback maximizes the leverage achieved by a battered wall, while providing a finished retaining wall that fulfills the goal of more useable flat land. Allan Block also has developed products with three and six degree nominal setbacks. The equations that follow can be used for each product by selecting the appropriate β angle ($\beta = 90 - \text{Wall Batter}$).

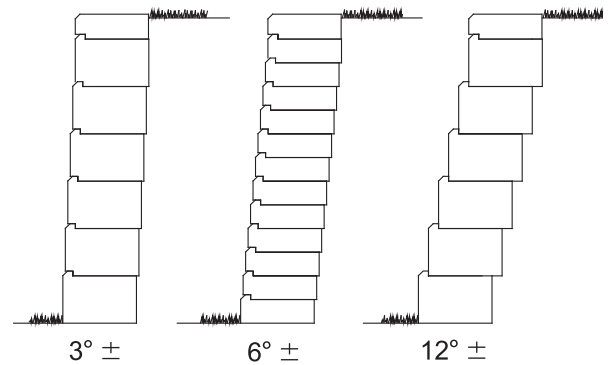

TABLE OF CONTENTS

Chapter One - Concepts & Definitions

• Soil Characteristics	1
• Retaining Wall Failure	2
<i>Sliding Failure</i>	2
<i>Overturning Failure</i>	2
<i>Effects of Water on Wall Stability</i>	2
• Types of Retaining Walls	3
<i>Simple Gravity</i>	3
<i>Tieback</i>	3
<i>Coherent Gravity</i>	3
• Forces Acting on Retaining Walls	4
• Soil States	4
• Active and Passive Zones	5
• Pressure Coefficients	5
• Active Force on the Wall	6
• Two-Dimensional Analysis	7
• Calculating the Effective Unit Weight of the Wall Facing	7
• Safety Factors	8

Chapter Two - Basic Wall Design Techniques

• Introduction	9
• Simple Gravity Walls	9
<i>Sliding Failure</i>	9
<i>Overturning Failure</i>	11
• Tieback Walls	12
<i>Earth Anchors as a Tieback</i>	14
• Coherent Gravity Walls	16
<i>Length of Geogrid</i>	16
<i>External Stability</i>	17
<i>Bearing Pressure on the Underlying Soil</i>	19
<i>Internal Stability</i>	22
<i>Attachment of the Geogrid to the Wall Facing</i>	23
<i>Mechanical Connection</i>	23
<i>Geogrid Pullout from the Soil</i>	26

Chapter Three - Surcharges

• Introduction	28
• Surcharges on Simple Gravity Walls	30
• Surcharges on Coherent Gravity Walls	32
<i>External Stability</i>	32
<i>Internal Stability</i>	37
• Terraced Walls	38

Chapter Four - Sloped Backfill

• Introduction	39
• Simple Gravity Walls with Sloped Backfill	39
• Coherent Gravity Walls with Sloped Backfill	40
<i>External Stability</i>	40
<i>Internal Stability</i>	42

Chapter Four - *Sloped Backfill - Continued*

- Coherent Gravity Walls with Broken Back Slopes 43

Chapter Five - *Seismic Analysis*

- Introduction 44
- Pressure Coefficients 44
- Dynamic Earth Force on the Wall 47
- Safety Factors 48
- Simple Gravity Wall with Seismic Influence 48
- Sliding Analysis 49
- Overturning Analysis 50
- Coherent Gravity Wall with Seismic Influence 52
 - Factor of Safety Against Sliding* 52
 - Factor of Safety Against Overturning* 52
 - Factor of Safety Against Sliding Analysis* 53
 - Factor of Safety Against Overturning Analysis* 54
 - Factor of Safety Geogrid Tensile Overstress* 55
 - Geogrid / Block Connection Capacity* 56
 - Geogrid Pullout from the Soil* 56
 - Localized Stability, Top of the Wall* 56
- Maximum Allowable Slopes in Seismic Conditions 57
- Trial Wedge Method of Determining Active Earth Pressure 58

Chapter Six - *Internal Compound Stability*

- Introduction 60
- Design Methodology 60
- Safety Factor of ICS 61
- Soil Sliding and Resisting Forces 61
 - Sliding Force* 62
 - Sliding Resisting Force* 62
- Modeling Multiple Soil Layers Behind Wall 63
- Surcharge and Seismic Forces 64
- Geogrid Contribution 65
- Wall Facing 66
 - Facing Stability from Geogrid Connections* 66
 - Facing Stability from Block Shear Strength* 67
 - Contribution from the Wall Face* 67
- Safety Factors and Design Approach 68

Chapter Seven - *Complex Composite Structures*

- Introduction 69
- Conducting an External Stability Analysis 71
- External Stability where the Upper Structure extends beyond the Lower Structure 71
- Internal Analysis Performed using an Internal Compound Stability (ICS) Analysis 73
- Top of Wall Stability Analysis 73
- Overview of Design Methods and Tools 74
- Examples of Complex Composite Structure configurations in AB Walls 74
 - Gravity Wall on Top of Geogrid Wall or No-Fines Wall* 74
 - Geogrid Wall Above or Below* 74
 - No-Fines on Top or Bottom of a Geogrid Wall Structure* 74
 - No-Fines on Top or Bottom with Varied Depth* 75
- AB Walls Design Software 75

Chapter Eight - *Limit Equilibrium Method (LEM)*

• LEM - Limit Equilibrium Method	81
• LEM Design Method as Compared to ICS	82
• Bishops Approach to Determine Forward Sliding Forces	83
• Determination of Sliding Force	84
• Determination of Sliding Resistance	85
• Block Shear Contribution.	85
• Transfer of Bishops Determined Forces to each Grid Layer	86
• Geogrid Pullout Requirements	87
• Using Soil Pullout Calculations to Determine Proper Length of Geogrid Layers, Required Geogrid Strength and Connection Requirements	88
• External Stability Calculations.	89
• Discussion on Various Structure Types and Grid Configurations	90
• Terraced Walls.	91
• Design Example	93

Appendix A

• AB Engineering Manual Variables	105
---	-----

Appendix B

• Allan Block Connection Tests and Shear Testing	108
--	-----

Appendix C

• Designing Balance Into Your Retaining Wall	111
--	-----

Appendix D

• Designing with No Fines Concrete in AB Walls Design Software	113
--	-----

Appendix E

• Building with No Fines Concrete	116
---	-----

Appendix F

• Sample Calculations	119
---------------------------------	-----

Appendix G

• Example - Limit States Design Analysis for a Gravity Wall	128
---	-----

References

.	131
-----------	-----

LIST OF FIGURES

Chapter One - Concepts & Definitions

Figure 1-1	Forces Acting on Retaining Walls	4
Figure 1-2	Relative Pressures for the Three Soil States	4
Figure 1-3	Theoretical Failure Surface	5
Figure 1-4	Definition for Active Force for Coulomb's Equation	5
Figure 1-5	Effect of Wall Friction on Active Force	6
Figure 1-6	Active Pressure Distribution on a Retaining Wall	6

Chapter Two - Basic Wall Design

Figure 2-1	Schematic Diagram of Simple Gravity Retaining Wall	11
Figure 2-2	Diagram of Retaining Wall for Tieback Analysis	12
Figure 2-3	Freebody Diagram of Retaining Wall for Tieback Analysis	12
Figure 2-4	Grouted Connection	15
Figure 2-5	Typical Coherent Gravity Wall	16
Figure 2-6	Coherent Gravity Wall for Example 2-3	16
Figure 2-7	Typical Geogrid Reinforcement Layout	16
Figure 2-8	Freebody Diagram of a Coherent Gravity Wall	18
Figure 2-9	Freebody Diagram for Bearing Pressure Analysis	19
Figure 2-10	Load Distribution of Specific Grid Layers	22
Figure 2-11	Line of Maximum Tension in a Coherent Gravity Wall	27

Chapter Three - Surcharges

Figure 3-1	Simple Gravity Retaining Wall with Surcharge	30
Figure 3-2	Freebody Diagram of a Simple Gravity Retaining Wall with Surcharge	31
Figure 3-3	Locations of Surcharge on Coherent Gravity Walls	32
Figure 3-4	Coherent Gravity Wall with Surcharge	37
Figure 3-5	Pressure Distributions Due to the Soil Weight and Surcharge	37
Figure 3-6	Retaining Wall with Three Tiers	38
Figure 3-7	Average Bearing Stress of Top Wall Applied as Surcharge to Second Wall	38

Chapter Four - Sloped Backfill

Figure 4-1	Coherent Gravity Wall with Sloped Backfill	40
Figure 4-2	Line of Maximum Tension in a Coherent Gravity Wall	42
Figure 4-3	Effect of Sloped Backfill on Spacing of Geogrid Layers	42
Figure 4-4	Effective Slope for Internal Calculations	43
Figure 4-5	Effective Slope for External Calculations	43
Figure 4-6	Effective Slope for Short Broken Back Slopes	43

Chapter Five - Seismic Analysis

Figure 5-1	Dynamic and Static Active Pressure Distribution	47
Figure 5-2	Free Body Diagram of Simple Gravity Wall Under Seismic Influence	48
Figure 5-3	Free Body Diagram of Coherent Gravity Wall Under Seismic Influence	52
Figure 5-4	Trapezoidal Method	56
Figure 5-5	Active Wedge Method	56
Figure 5-6	Pullout of Soil (Seismic)	56
Figure 5-7	Triangular Wedge Method	58
Figure 5-8	Active Earth Pressure	59

Chapter Six - *Internal Compound Stability*

Figure 6-1	Internal Compound Analysis.....	60
Figure 6-2	Internal Compound Stability Design Envelope	60
Figure 6-3	Internal Compound Stability Diagram.....	61
Figure 6-4	Lost Soil Weight.....	61
Figure 6-5	Wedge Force Diagram	61
Figure 6-6	Wedge Weight	62
Figure 6-7	Multiple Soil Layers	63
Figure 6-8	Effects of Surcharge Loading	64
Figure 6-9	Geogrid Contribution at the Slip Arc	65
Figure 6-10	Grid Force.....	65
Figure 6-11	Geogrid Contribution to the Wall Face Case A.....	66
Figure 6-12	Geogrid Contribution to the Wall Face Case B.....	66
Figure 6-13	Geogrid Contribution to the Wall Face Case C	66
Figure 6-14	Facing Instability.....	67
Figure 6-15	Facing Stability	67
Figure 6-16	ICS Force Summary	68

Chapter Seven - *Complex Composite Structures*

Figure 7-1	Complex Composite Structure (CCS).....	69
Figure 7-2	ICS Design Envelope Diagram.....	69
Figure 7-3	Secondary Reinforcement Layers	70
Figure 7-4	Modified Bishops Method	70
Figure 7-5	Grid Above Grid CCS	70
Figure 7-6	Grid Above No Fines CCS.....	70
Figure 7-7	Upper Structure Force Diagram	70
Figure 7-8	Top of Wall Stability Diagram.....	70
Figure 7-9	Lower Structure Force Diagram	71
Figure 7-10	Lower Structure Force Diagram (Shallow Base).....	71
Figure 7-11	Bearing Behind Lower Structure.....	72
Figure 7-12	ICS Design Envelope and Forces	73
Figure 7-13	ICS Pressure Map Diagram.....	73
Figure 7-14	Standard Above Wall Configuration.....	73
Figure 7-15	Long Anchoring Unit Above	73
Figure 7-16	Irregular Configuration Above.....	73
Figure 7-17	Examples of CCS Structures in AB Walls.....	74
Figure 7-18	No-Fines with Varied Depth.....	75
Figure 7-19	Example Section - Loads.....	76
Figure 7-20	Example Section - Moment Arms	78
Figure 7-21	Example Section - Pressure Map.....	79
Figure 7-22	Bearing Capacity Diagram.....	79

Chapter Eight - *Limit Equilibrium Method (LEM)*

Figure 8-1	Limit Equilibrium Method	81
Figure 8-2	Slip Arcs Compared to ICS Slip Arcs.....	82
Figure 8-4	Slip Arcs Developed at Each Cord.....	83
Figure 8-5	Lost Soil Weight	83
Figure 8-6	Slice Force Diagram	84
Figure 8-7	Slice Weights	84
Figure 8-8	Shear Configuration.....	84
Figure 8-9	Forward Sliding Force Determination.....	85
Figure 8-10	Arc / Grid Layer Intersection Angle	86
Figure 8-11	Top Down Approach.....	86
Figure 8-12	Geogrid Pullout Envelope.....	87
Figure 8-13	Geogrid Pullout Confining Pressure	87
Figure 8-14	T_{req} Envelope Compared to Geogrid Pullout Resistance Envelope	88
Figure 8-15	LEM.....	88
Figure 8-16	Force Between Grid.....	89
Figure 8-17	End Development.....	89
Figure 8-18	Standard Wall Using LEM.....	89
Figure 8-19	Complex Composite Structure (CCS)	90
Figure 8-20	Secondary Geogrid Layers	90
Figure 8-21	Retaining Wall with Three Terraces.....	91
Figure 8-22	Average Bearing Stress of Top Wall Applied as Surcharge to Second Wall	91
Figure 8-23	Terraced Section Using LEM.....	91
Figure 8-24	Additional Considerations.....	92

CHAPTER ONE

Concepts & Definitions

Soil Characteristics

Soil can be described in many different ways. One way to describe it is by the average size of the particles that make up a soil sample. Sandy soil consists of relatively large particles, while clay soil consists mainly of smaller particles. Another way to describe soil is by the tendency of the particles to stick together -- a property called cohesion. Sand, such as is found at the beach, has very low cohesion. Even when it is wet, you can pick up a handful of sand and it will pour out of your hand as individual particles. Clay, on the other hand, is much more cohesive than sand. A wet clay soil can be molded into a ball or rolled into a thread that resists being pulled apart.

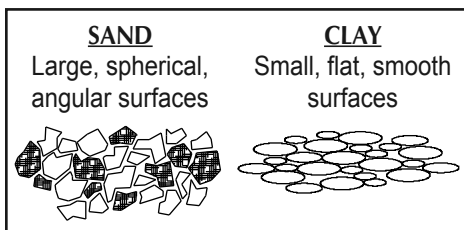

Still another way to describe a soil is by its natural tendency to resist movement. This property can be expressed by a number known as the effective friction angle, or simply, the friction angle (ϕ). It should be noted that the design methodology outlined in this manual uses the effective friction angle without the addition of cohesion to increase the design strength of the soil. At the discretion of the engineer of record, cohesion may be used when calculating the ultimate bearing capacity even though it is typically ignored.

If you take a dry soil sample and pour it out onto a flat surface, it will form a cone-shaped pile. The angle formed by the base of the cone and its sides is known as the angle of repose. The angle of repose of a soil is always smaller than the friction angle for the same soil. However, the difference between the two angles is small and for the design of retaining walls the angle of repose can be used to approximate the friction angle. The larger the friction angle the steeper the stable slope that can be formed using that soil.

Soil that consists mainly of sand has a larger friction angle than soil composed mainly of clay. This is due to the fact that sand particles are roughly spherical with irregular surfaces, while clay particles are flat and smooth. When subjected to external pressure, the clay particles tend to slide past one another. The surface irregularities of the sand particles tend to interlock and resist movement.

Clay soil has some characteristics that make it undesirable for use as backfill for a retaining wall. First of all, clay soil is not readily permeable and retains the water that filters into it. The added weight of the retained water increases the force on the retaining wall. Secondly, once the clay becomes saturated, its cohesion decreases almost to zero. The shear strength of the soil is the sum of the frictional resistance to movement and the cohesion of the soil. Once the cohesion is lost due to soil saturation, the full force of the weight of water and most of the weight of the soil is applied to the wall. For these reasons, clay soil is not a good choice for retaining wall backfill.

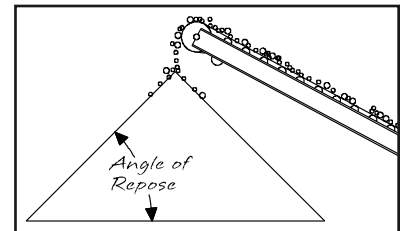

The preferred soil for backfill behind retaining walls is soil that contains a high percentage of sand and gravel. Such a soil is referred to as a granular soil and has a friction angle of approximately 32° to 36°, depending on the degree of compaction of the soil. The main reason for preferring a granular soil for backfill is that it allows water to pass through it more readily than a nongranular, or clayey soil does. Also, the shear strength of a granular soil doesn't vary with moisture content and therefore its shear strength is more predictable.

Infill material shall be site excavated soils when approved by the on-site soils engineer unless otherwise specified in the drawings. Un-suitable soils for backfill (heavy clays or organic soils) shall not be used in the reinforced soil mass. Fine grained cohesive soils ($\phi < 31$) may be used in wall construction, but additional backfilling, compaction and water management efforts are required. Poorly graded sands, expansive clays and/or soils with a plasticity index (PI) >20 or a liquid limit (LL) >40 should not be used in wall construction.

While cohesionless free draining materials (less than 10% fines and/or plasticity index less than 6 and liquid limit less than 30) are preferred, soils with low plasticity fines (ie: CL, ML, SM, SC, with PI less than 20 and LL less than 40) may be used for SRW construction under certain conditions.

Typical Soil Properties			
Soil Groups	Cohesion Compacted	Cohesion Saturated	Soil Friction Angle
Clean Gravel-Sand Mix	0	0	36°
Sand-Silt Clay Mix	1050 PSF (50 KPA)	300 PSF (14 KPA)	32°
Inorganic Clays	1800 PSF (86 KPA)	270 PSF (13 KPA)	27°

Retaining Wall Failure

There are two primary modes of retaining wall failure. The wall can fail by sliding too far forward and encroaching on the space it was designed to protect. It can also fail by overturning -- by rotating forward onto its face.

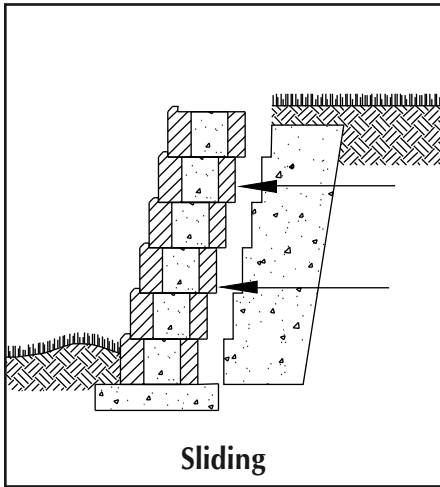

Sliding Failure

Sliding failure is evident when the wall moves forward, and occurs when the horizontal forces tending to cause sliding are greater than the horizontal forces resisting sliding. Generally, this will occur when either the driving force is underestimated or the resisting force is overestimated. Underestimating the driving force is the most common mistake and usually results from: 1) neglecting surcharge forces from other walls, 2) designing for level backfill when the backfill is in fact sloped, 3) using cohesive soils for backfill.

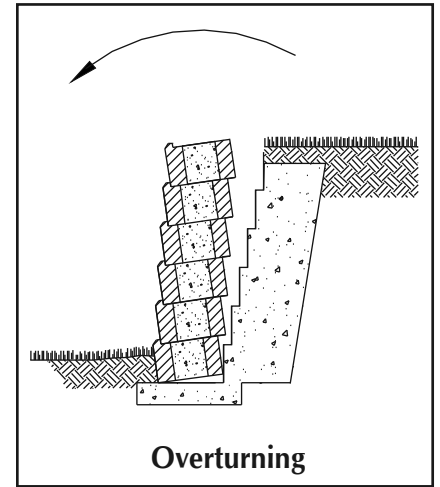

Overturning Failure

Overturning failure is evident when the wall rotates about its bottom front edge (also called the toe of the wall). This occurs when the sum of the moments tending to cause overturning is greater than the sum of the moments resisting overturning. As with sliding failures, overturning failures usually result from underestimating the driving forces.

Effects of Water on Wall Stability

Perhaps the single most important factor in wall failure is water. Water contributes to wall failure in several different ways. If the soil used for backfill is not a free-draining granular soil, it will retain most of the water that filters into it. The force on a wall due to water can be greater than the force due to soil. Walls with greater setbacks have a larger natural resistance to overturning.

As the moisture content of the soil increases, the unit weight of the soil increases also, resulting in greater force on the wall. When the soil becomes saturated, the unit weight of the soil is reduced because of the buoyant force of the water on the soil particles. However, the water exerts hydrostatic pressure on the wall. Therefore, the total force on the wall is greater than it is for unsaturated soil, because the force on the wall is the sum of the force exerted by the soil and the force exerted by the water. The problem is even greater if the soil contains a high percentage of clay. Saturated, high-clay-content soil loses its cohesion and the force on the wall increases. Good drainage is essential for proper wall design.

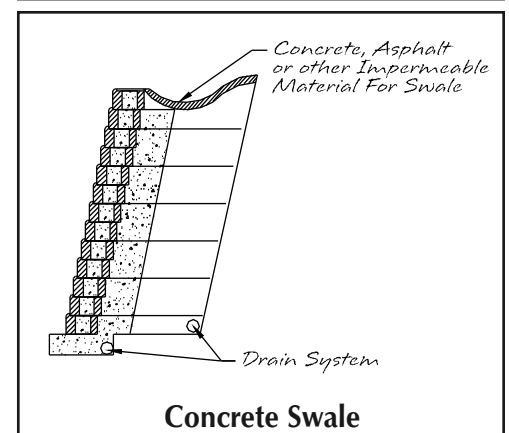
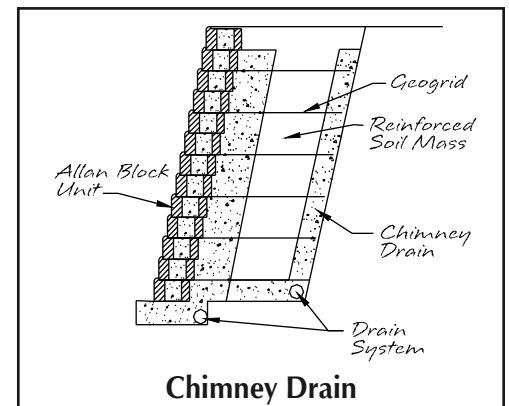
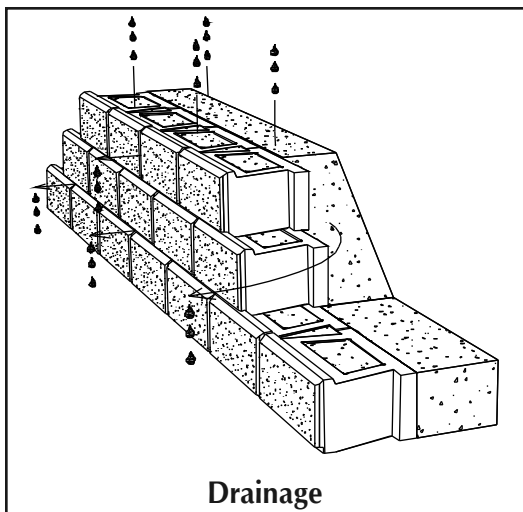

Some clay soils exhibit the characteristic of expanding when wet. This expansion, coupled with contraction when the soil dries, can work to weaken the soil mass and cause failure.

Another way in which water contributes to wall failure is by the action of the freeze-thaw cycle. Water trapped in the soil expands when it freezes causing increased pressure on the wall. Water in contact with the wall itself can also cause failure of the concrete within the block.

Several things can be done to reduce the likelihood of wall failure due to water. First, use a free-draining granular material for the backfill. Second, create a drain field in and around the block cores and 12 inches (300 mm) deep behind the wall using a material with large individual particles, such as gravel. Third, install a drain pipe at the bottom rear of the base and provide outlets as needed. Finally, direct water away from the top and bottom of the wall using swales as required. All these measures will ensure that excess water is removed from behind the wall before it can build up or freeze and cause damage.

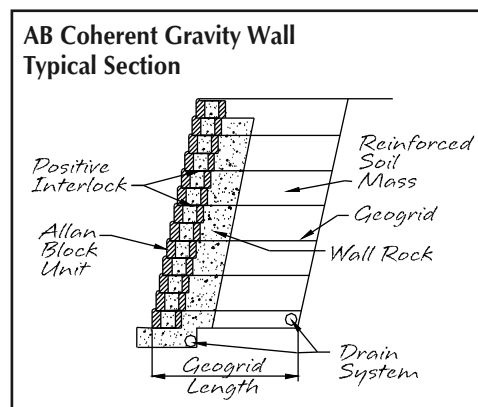
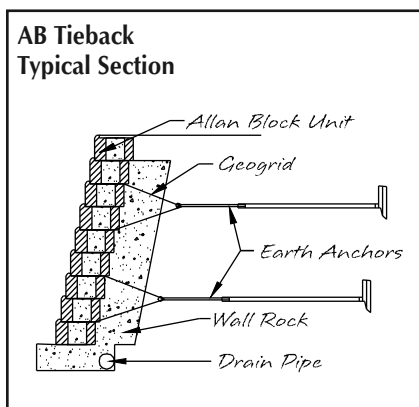
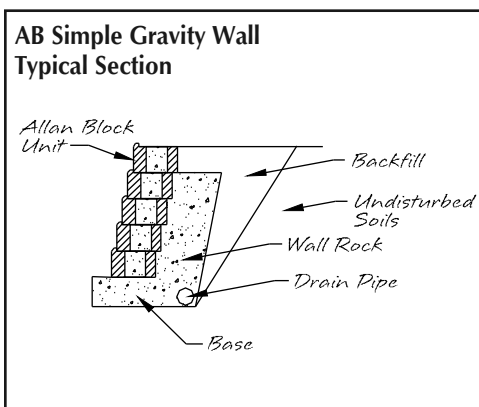

Types of Retaining Walls

• Simple Gravity

A wall that relies solely on its weight to prevent failure is called a gravity wall. For a gravity wall, the primary factor affecting the wall's resistance to overturning is the horizontal distance from the toe of the wall to the center of gravity of the wall. The greater this distance is, the less likely it is that the wall will overturn. For example, a wall four feet high and two feet thick will have a lower resistance to overturning than a wall two feet high and four feet thick, even if the weights are equal. **Battering the retaining wall also enhances stability by moving the center of gravity back from the toe of the wall and reducing the load applied to the wall from the soil.**

• Tieback

Anchor reinforced walls rely on mechanical devices embedded in the backfill to provide the force necessary to resist sliding and overturning. **Battering an anchor reinforced wall will shift its center of gravity and enhance its stability. Examples of tieback walls will include: earth anchors and soil nails.**

• Coherent Gravity

Coherent gravity walls, also known as Geogrid reinforced walls, combine the mass of the wall facing with the mass of the soil behind into one coherent mass that together resists sliding and overturning. Coherent gravity walls use a flexible synthetic mesh (geogrid) to stabilize the soil. Studies have shown that retaining walls reinforced with several layers of geogrid act as giant gravity walls. **“Geogrid reinforced soil masses create the same effect as having an extremely thick wall with the center of gravity located well back from the toe of the wall.”** For this reason, reinforced soil walls are more likely to fail by sliding than by overturning.

Forces Acting on Retaining Walls

The forces that act on a retaining wall can be divided into two groups:

- Those forces that tend to cause the wall to move
- Those forces that oppose movement of the wall (see Figure 1-1)

Included in the first group are the weight of the soil behind the retaining wall and any surcharge on the backfill. Typical surcharges include driveways, roads, buildings, and other retaining walls. Forces that oppose movement of the wall include the frictional resistance to sliding due to the weight of the wall, the passive resistance of the soil in front of the wall, and the force provided by mechanical restraining devices. When the forces that tend to cause the wall to move become greater than the forces resisting movement, the wall will not be stable.

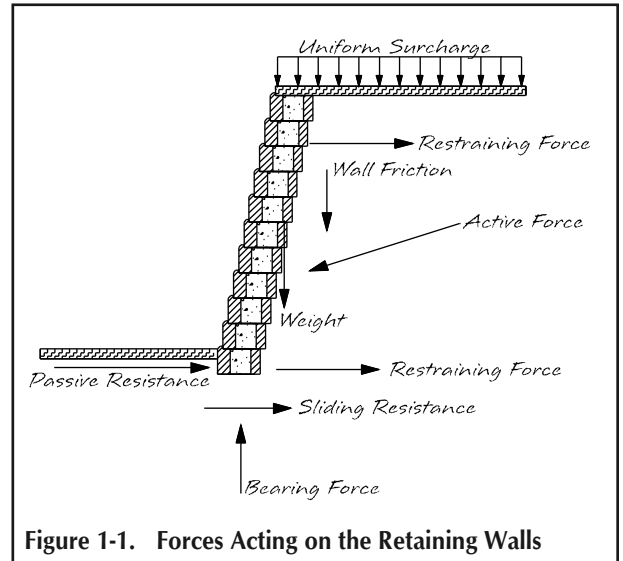

Figure 1-1. Forces Acting on the Retaining Walls

Soil States

The soil behind a retaining wall exists in one of three states:

- 1) the active state, 2) the passive state, 3) the at-rest state.

When a wall is built and soil is placed behind it and compacted, the soil is in the *at-rest state*. If the pressure on the wall due to the soil is too great, the wall will move forward. As the wall moves forward, the soil settles into a new equilibrium condition called the *active state*. The pressure on the wall due to the soil is lower in the active state than it is in the at-rest state (see Figure 1-2).

The *passive state* is achieved when a wall is pushed back into the soil. This could occur by building the retaining wall, placing and compacting the soil, and then somehow forcing the retaining wall to move into the backfill. Usually, the passive state occurs at the toe of the wall when the wall moves forward. The movement of the wall causes a horizontal pressure on the soil in front of the wall. This passive resistance of the soil in front of the wall helps keep the wall from sliding. However, the magnitude of the passive resistance at the toe of the wall is so low that it is usually neglected in determining the stability of the wall.

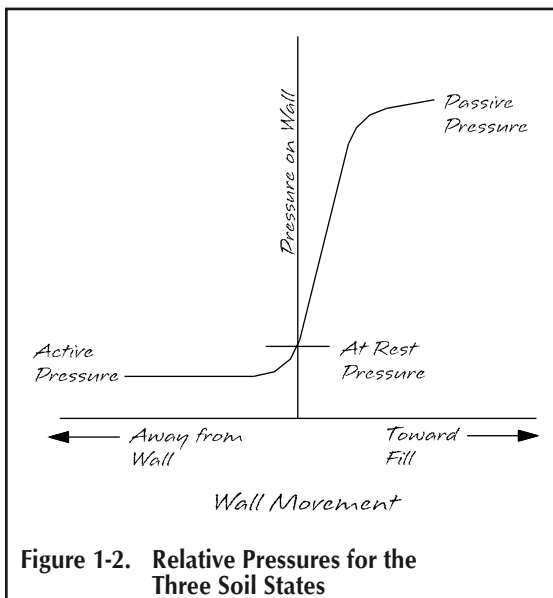

Figure 1-2. Relative Pressures for the Three Soil States

The occurrence of the passive state behind a retaining wall is extremely rare and it will most likely never be encountered behind an Allan Block wall. The *at-rest condition* occurs whenever a retaining wall is built. Some designers may prefer to take a conservative approach and design for the higher at-rest pressure rather than the active pressure. However, this is not necessary since the amount of wall movement required to cause the pressure to decrease from the at-rest level to the active level is very small. Studies of soil pressure on retaining walls have shown that the top of a retaining wall needs to move only 0.001 times the height of the wall in order for the pressure to drop to the active value.

There are some applications where the wall cannot be allowed to move. These include bridge abutments and walls that are rigidly connected to buildings. In cases such as these, the design should be based on the higher at-rest pressure; otherwise, the lower active pressure can be used. Designing on the basis of the active pressure will reduce the cost of the wall and give a more accurate model of the actual behavior of most retaining walls.

Active and Passive Zones

When the wall moves forward, a certain portion of the soil behind the wall moves forward also. The area containing the soil that moves with the wall is referred to as the *active zone*. The area behind the active zone is called the *passive zone*. The line that divides the two zones is called Theoretical Failure Surface or the Line of Maximum Tension. This can be estimated by drawing a line that begins at the bottom rear edge of the wall and extends into the backfill at an angle of 45° plus one-half the friction angle of the soil ($45^\circ + \phi/2$) and intersects a vertical line 0.3 times the height of the wall ($H \times 0.3$), Figure 1-3.

The active zone for a geogrid reinforced soil mass includes the entire reinforcement zone and the area included in the theoretical failure surface. The origin of the theoretical failure surface is located at the back bottom of the reinforced zone.

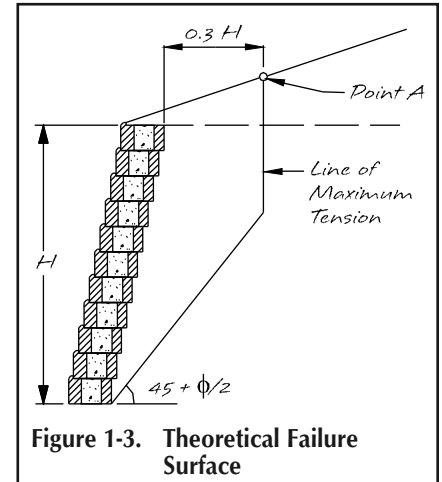

Pressure Coefficients

The horizontal stress (σ_h) on a retaining wall due to the retained soil is directly proportional to the vertical stress (σ_v) on the soil at the same depth. The ratio of the two stresses is a constant called the *pressure coefficient*:

$$K = \frac{(\sigma_h)}{(\sigma_v)}$$

The pressure coefficient for the at-rest state can be calculated using the formula:

$$K_o = 1 - \sin(\phi)$$

The active pressure coefficient can be calculated using an equation that was derived by Coulomb in 1776. This equation takes into account the slope of the backfill, the batter of the retaining wall, and the effects of friction between the retained soil and the surface of the retaining wall. Figure 1-4 illustrates the various terms of Coulomb's equation.

where:

ϕ = the friction angle of the soil.

F_a = the active force on the retaining wall; it is the resultant force of the active pressure on the retaining wall

H = distance from the bottom of the wall to the top of the wall

γ = unit weight of the soil

β = angle between the horizontal and the sloped back face of the wall

i = back slope at the top of the retaining wall

ϕ_w = angle between a line perpendicular to the wall face and the line of action of the active force

K_a = the active pressure coefficient

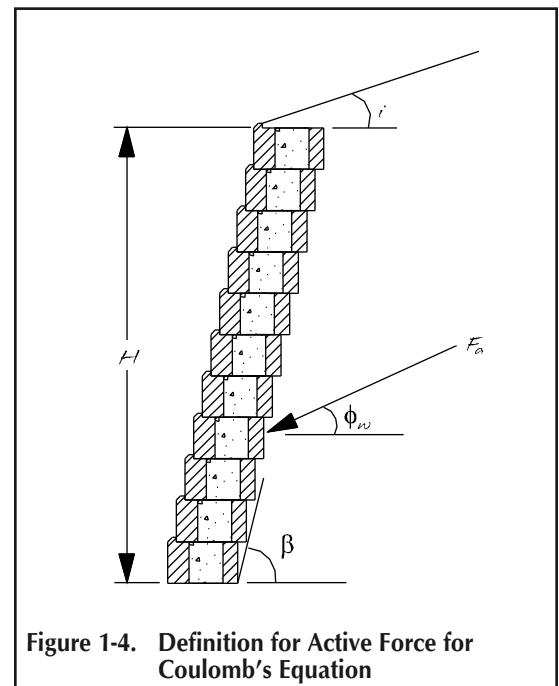
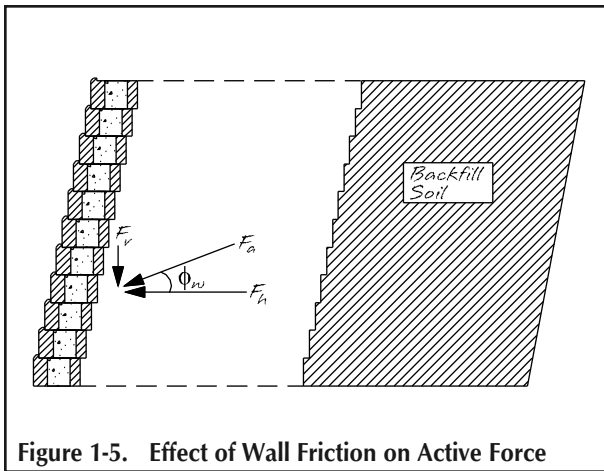

Figure 1-4. Definition for Active Force for Coulomb's Equation

$$K_a = \left[\frac{\csc(\beta) \sin(\beta - \phi)}{\sqrt{\sin(\beta + \phi_w)} + \sqrt{\frac{\sin(\phi + \phi_w) \sin(\phi - i)}{\sin(\beta - i)}}} \right]^2$$



As the wall moves forward slightly, the soil enters the active state by moving forward and downward. At the interface of the soil and the wall, this downward movement of the wall is resisted by the friction between the soil and the wall. Figure 1-5 shows the resultant active force on a retaining wall and the effect of wall friction on the direction of the force.

The magnitude of ϕ_w varies depending on the compaction level of the backfill. For a loose backfill, ϕ_w is approximately equal to ϕ . For a dense back-fill, however, $\phi_w < \phi$. Since retaining wall backfill is thoroughly compacted, the design method in this manual assumes that $\phi_w = (0.66) \phi$.

Active Force on the Wall

Once the active pressure coefficient has been determined, the active force on the wall can be determined. Figure 1-6 shows the active pressure distribution on a retaining wall. The active pressure distribution is triangular, which reflects the fact that soil pressure increases linearly with soil depth. The vertical pressure at any depth is given by:

$$P_v = (\gamma) (H)$$

Where:

γ = the unit weight of the soil

H = the depth from the top of the retained soil mass.

As discussed previously, the horizontal pressure (P_h) is related to the vertical pressure (P_v) by the active pressure coefficient:

$$K_a = \frac{(P_h)}{(P_v)}$$

Since K_a and γ are constants, the horizontal pressure increases linearly as the depth increases and the resulting pressure distribution is triangular. The magnitude of the resultant force of a triangular pressure distribution is equal to the area of the triangle. The pressure at the base of the triangle is given by:

$$P_h = (K_a) (\gamma) (H)$$

The magnitude of the active force is:

$$\begin{aligned} F_a &= (\text{area of the triangle}) \\ &= (0.5) (\text{base}) (\text{height}) \\ &= (0.5) (P_{hb}) (H) \\ &= (0.5) (\gamma) (K_a) (H) (H) \\ &= (0.5) (\gamma) (K_a) (H)^2 \end{aligned}$$

Therefore, the equation for the active force on a retaining wall is:

$$F_a = (0.5) (\gamma) (K_a) (H)^2$$

The resultant force acts at a point above the base equal to one-third of the height of the triangle. Adding a surcharge or slope above the wall has the effect of adding a rectangular pressure distribution. The resultant force of a rectangular pressure distribution acts at a point above the base equal to one-half of the height of the rectangle.

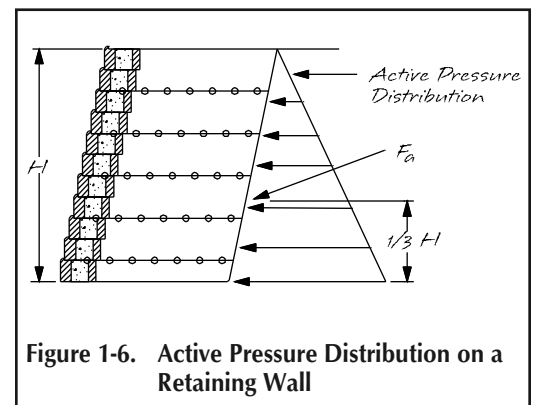

Figure 1-6. Active Pressure Distribution on a Retaining Wall

Two-Dimensional Analysis

A retaining wall is a three-dimensional object. It has height, length, and depth. In order to simplify the analysis, the length of the wall is taken to be one foot (or one meter) and the wall is analyzed as a two-dimensional system. Because of this, the units for forces will always be *pounds per foot* (lb/ft) (newtons per meter (N/m)), and the units for moments will be *foot-pounds per foot* (ft-lb/ft) (newton-meters per meter (N-m/m)).

Calculating the Effective Unit Weight of the Wall Facing

The effective unit weight of the wall facing is often needed for wall design. Allan Block's unit weight is the sum of the blocks plus the wall rock material and is calculated below. Concrete usually weighs more than soil. A typical unit weight for concrete is 135 lb/ft³ (2,163 kg/m³) while a typical unit weight for soil is 120 lb/ft³ (1,923 kg/m³). Depending on the size of the wall, this difference may be significant, and the design engineer should know how to calculate the weight of the wall facing.

The weight of a AB Stone unit is approximately 72 lbs (33 kg). The unit weight of the concrete is 135 lb/ft³ (2,163 kg/m³). The block dimensions used are: Length (l) = 1.5 ft (0.46 m), Height (h) = 0.635 ft (0.19 m) and Depth (t) = 0.97 ft (0.3 m). From these values, the volume of concrete for each Allan Block unit can be calculated:

$$V_c = \frac{(72 \text{ lb})}{(135 \text{ lb/ft}^3)} = 0.53 \text{ ft}^3$$

$$= \frac{(33 \text{ kg})}{(2,163 \text{ kg/m}^3)} = 0.015 \text{ m}^3$$

The total volume occupied by each standard Allan Block unit, including the voids, is:

$$\begin{aligned} V_{\text{tot}} &= (1.5 \text{ ft}) (0.635 \text{ ft}) (0.97 \text{ ft}) \\ &= 0.92 \text{ ft}^3 \\ &= (0.46 \text{ m}) (0.19 \text{ m}) (0.3 \text{ m}) \\ &= 0.026 \text{ m}^3 \end{aligned}$$

Therefore, the volume of the voids is:

$$\begin{aligned} V_v &= V_{\text{tot}} - V_c \\ &= 0.92 \text{ ft}^3 - 0.53 \text{ ft}^3 \\ &= 0.39 \text{ ft}^3 \\ &= 0.026 \text{ m}^3 - 0.015 \text{ m}^3 \\ &= 0.011 \text{ m}^3 \end{aligned}$$

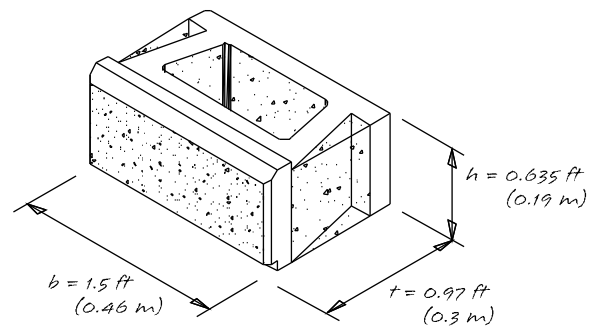

Total Unit Weight

The unit weight of the wall facing can now be calculated. Assuming that the voids are filled with wall rock with a unit weight of 120 lb/ft³ (1,923 kg/m³), the unit weight of the wall facing is:

$$\begin{aligned} \gamma_{\text{wall}} &= \frac{(\text{weight of concrete}) + (\text{weight of wall rock})}{(\text{volume of block})} \\ &= \frac{(\text{weight of concrete}) + (\text{weight of wall rock})}{(V_{\text{tot}})} \\ &= \frac{(0.53 \text{ ft}^3) (135 \text{ lb/ft}^3) + (0.39 \text{ ft}^3) (120 \text{ lb/ft}^3)}{(0.92 \text{ ft}^3)} = 129 \text{ lb/ft}^3 \end{aligned}$$

$$= \frac{(0.015 \text{ m}^3) (2,163 \text{ kg/m}^3) + (0.011 \text{ m}^3) (1,923 \text{ kg/m}^3)}{0.026 \text{ m}^3} = 2,061 \text{ kg/m}^3$$

Once the unit weight of the wall facing is known, it is a simple matter to calculate the weight per linear foot of wall:

$$\begin{aligned}W_f &= (\text{unit weight of wall}) (\text{volume of wall}) \\ &= (\text{unit weight of wall}) (\text{wall height}) (\text{facing depth}) \\ &= (\gamma_{\text{wall}})(V_w) \\ &= (\gamma_{\text{wall}})(H)(t)\end{aligned}$$

For a wall 5.72 feet (1.74 m) tall with a facing depth of 0.97 foot (0.3 m), the weight of the facing would be:

$$\begin{aligned}W_f &= (129 \text{ lb/ft}^3) (5.72 \text{ ft}) (0.97 \text{ ft}) &= (2,061 \text{ kg/m}^3) (1.74 \text{ m}) (0.3 \text{ m}) \\ &= 716 \text{ lb/ft} &= 1,076 \text{ kg/m}\end{aligned}$$

In general, the weight of the facing is:

$$W_f = (125 \text{ lb/ft}^2) (\text{wall height}) = (610 \text{ kg/m}^2) (\text{wall height})$$

Safety Factors

The safety factors used in this design manual conform to the guidelines of the Federal Highway Administration, Mechanically Stabilized Earth Walls and Reinforced Soil Slopes - Design and Construction Guidelines. They recommend using the following safety factors:

Sliding > 1.5

Overturning > 2.0

Internal Compound Stability > 1.3

Global Stability > 1.3

Bearing Capacity > 2.0

Grid Overstress > 1.5

Pullout of Soil > 1.5

Pullout of Block > 1.5

These are the same values recommended by most governmental agencies and organizations (AASHTO, NCMA). However, you should check your state and local building codes to make sure these safety factors are sufficient.

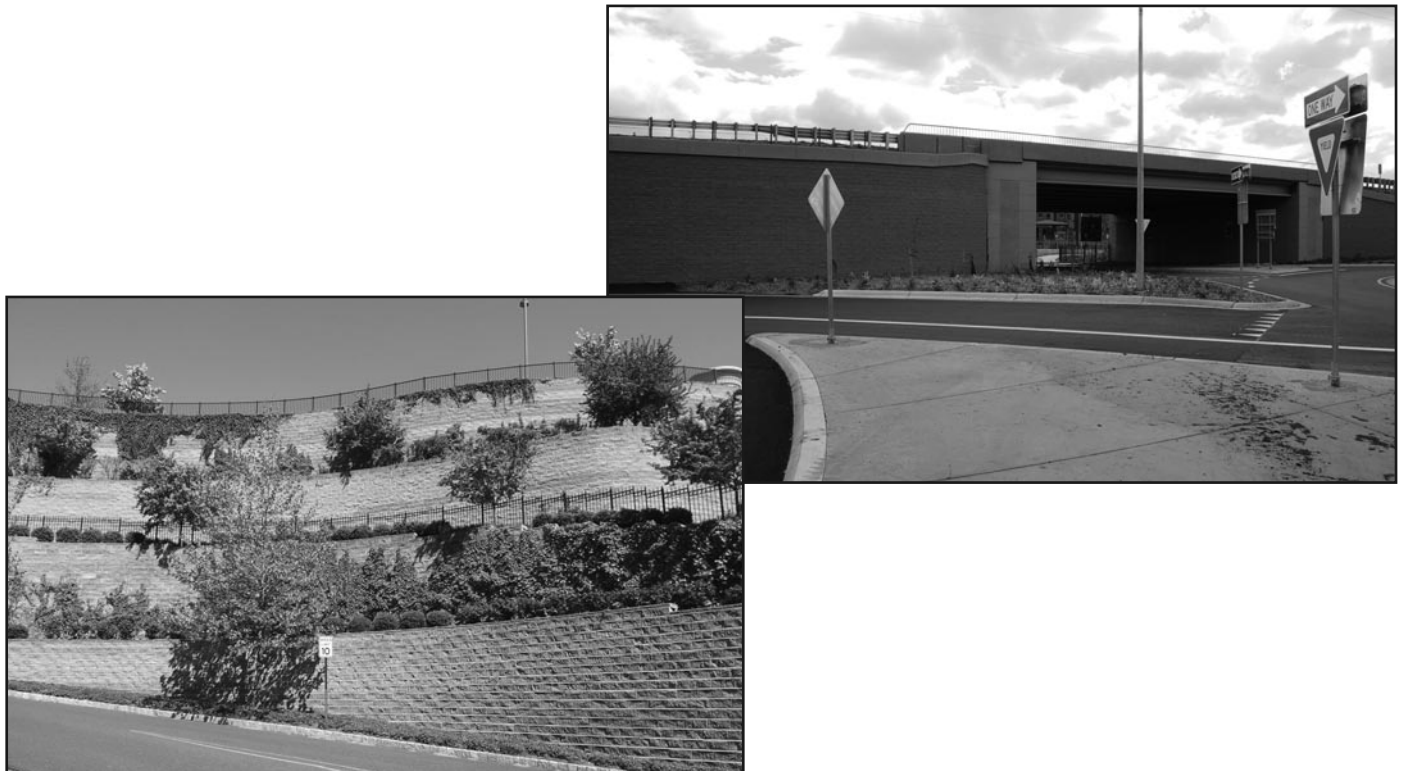

CHAPTER TWO

Basic Wall Design Techniques



Gravity Wall



Tieback Wall



Coherent Gravity Wall

Introduction

One way to classify retaining walls is by the type of reinforcement the walls require. If a wall is stable without reinforcement, it is referred to as a simple gravity wall. When the forces behind a wall are greater than a simple gravity system can provide, a tieback wall can often be built using anchors to tie the wall to the soil or a coherent gravity wall can be built by using two or more layers of geogrid to stabilize the soil mass.

Simple Gravity Walls

Simple gravity walls rely on the weight of the wall to counteract the force of the retained soil. Figure 2-1 is a diagram showing the forces acting on a simple gravity wall. Two modes of failure must be analyzed, sliding and overturning.

Sliding Failure

A simple gravity wall will not fail in sliding if the force resisting sliding, F_r , is greater than or equal to the force causing sliding, F_h . The force resisting sliding is the frictional resistance at the wall base. The minimum safety factor for sliding failure is 1.5. Therefore, F_r must be greater than or equal to $(1.5) F_h$. The following example illustrates the procedure for analyzing stability in sliding.

Example 2-1A: (6 course wall)

Given:

$\phi = 30^\circ$	$H = 3.81 \text{ ft}$	(1.16 m)
$i = 0^\circ$	$\gamma = 120 \text{ lb/ft}^3$	$(1,923 \text{ kg/m}^3)$
$\beta = 78^\circ$	$\phi_w = (0.666) (\phi) = 20^\circ$	
$K_a = 0.2197$	$\gamma_{\text{wall}} = 130 \text{ lb/ft}^3$	$(2,061 \text{ kg/m}^3)$

Find: The safety factor against sliding, SFS.

The first step is to determine the total active force exerted by the soil on the wall:

$$\begin{aligned}
 F_a &= (0.5) (\gamma) (K_a) (H)^2 \\
 &= (0.5) (120 \text{ lb/ft}^3) (0.2197) (3.81 \text{ ft})^2 = 191 \text{ lb/ft} \\
 &= (0.5) (1,923 \text{ kg/m}^3) (9.81 \text{ m/sec}^2) (0.2197) (1.16 \text{ m})^2 = 2,788 \text{ N/m}
 \end{aligned}$$

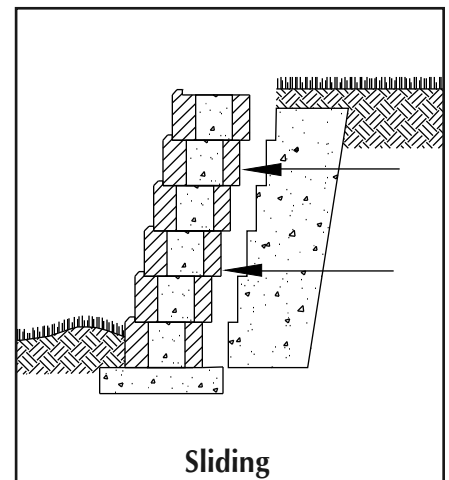
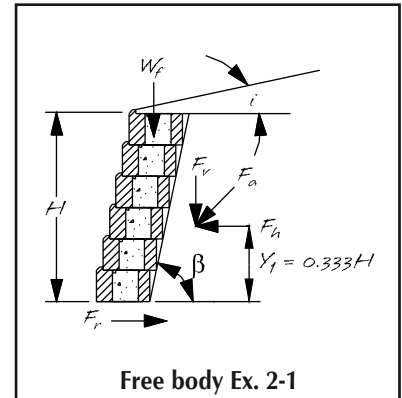

As explained in Chapter One, because of the effects of friction between the soil and the wall, the active force acts at an angle to a line perpendicular to the face of the wall. The active force can be resolved into a component perpendicular to the wall and a component parallel to the wall.

The degree of the angle between the active force and a line perpendicular to the face of the wall is ϕ_w . ϕ_w varies according to the compaction level of the soil. For very loose soil, ϕ_w approaches ϕ ; for compacted soil, ϕ_w can be as low as $(0.666) \phi$. Since our wall designs involve compacting the backfill soil, we use the more conservative value of $\phi_w = (0.666) \phi$. Thus, the horizontal component of the active force is:

$$\begin{aligned} F_h &= (F_a) \cos (\phi_w) \\ &= (F_a) \cos [(0.666) (\phi)] \\ &= (191 \text{ lb/ft}) \cos (20^\circ) &= (2,788 \text{ N/m}) \cos (20^\circ) \\ &= 179 \text{ lb/ft} &= 2,620 \text{ N/m} \end{aligned}$$

Similarly, the vertical component of the active force is:

$$\begin{aligned} F_v &= (F_a) \sin (\phi_w) \\ &= (F_a) \sin [(0.666) (\phi)] \\ &= (191 \text{ lb/ft}) \sin (20^\circ) &= (2,788 \text{ N/m}) \sin (20^\circ) \\ &= 65 \text{ lb/ft} &= 954 \text{ N/m} \end{aligned}$$

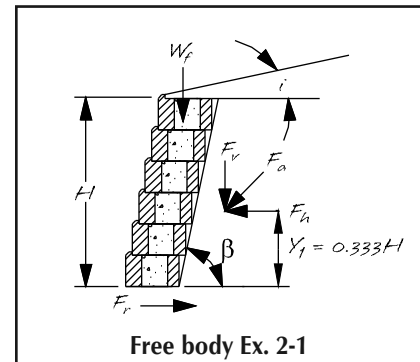

The weight of the wall facing must be determined before the frictional resistance to sliding can be calculated:

$$\begin{aligned} W_f &= (\gamma_{\text{wall}}) (H) (t) \\ &= (130 \text{ lb/ft}^3) (3.81 \text{ ft}) (0.97 \text{ ft}) &= (2061 \text{ kg/m}^3) (1.16 \text{ m}) (0.3 \text{ m}) (9.81 \text{ m/sec}^2) \\ &= 480 \text{ lb/ft} &= 7,036 \text{ N/m} \end{aligned}$$

The maximum frictional resistance to sliding, F_r is calculated by multiplying the total vertical force, V_t , by the coefficient of friction. The total vertical force is the sum of the weight of the wall and the vertical component of the active force. The coefficient of friction, C_f , is assumed to be equal to $\tan (\phi)$. Thus, the maximum frictional resistance is:

$$\begin{aligned} F_r &= (V_t) (C_f) \\ &= (V_t) \tan (\phi) \\ &= (W_f + F_v) \tan (\phi) \\ &= (480 \text{ lb/ft} + 65 \text{ lb/ft}) \tan (30^\circ) &= (7,036 \text{ N/m} + 954 \text{ N/m}) \tan (30^\circ) \\ &= 315 \text{ lb/ft} &= 4,613 \text{ N/m} \end{aligned}$$

Finally, the safety factor against sliding can be calculated:

$$\begin{aligned} \text{SFS} &= \frac{(\text{Force resisting sliding})}{(\text{Force causing sliding})} = \frac{F_r}{F_h} \\ &= \frac{(315 \text{ lb/ft})}{(179 \text{ lb/ft})} = 1.8 \geq 1.5 \text{ OK} &= \frac{(4,613 \text{ N/m})}{(2,620 \text{ N/m})} = 1.8 \geq 1.5 \text{ OK} \end{aligned}$$

The safety factor against sliding is greater than 1.5. Therefore, the wall is stable and doesn't require reinforcement to prevent sliding failure. However, the wall must still be analyzed for overturning failure.

Overturning Failure

Overturning failure occurs when the forces acting on the wall cause it to rotate about the bottom front corner of the wall (Point A in Figure 2-1). For stability, the moments resisting overturning, M_r , must be greater than or equal to the moments causing overturning, M_o . The minimum safety factor for overturning is 2.0. Therefore, M_r must be greater than or equal to $(2.0) M_o$.

Example 2-1B:

Find the safety factor against overturning, SFO, for Example 2-1.

Two forces contribute to the moment resisting overturning of the wall. These are the weight of the wall and the vertical component of the active force on the wall. Summing these moments about Point A:

$$\begin{aligned}
 M_r &= (W_f) [(t/2) + (0.5) (H) \tan (90^\circ - \beta)] + (F_v) [(t) + (0.333) (H) \tan (90^\circ - \beta)] \\
 &= (480 \text{ lb/ft}) [(0.49 \text{ ft}) + (0.5) (3.81 \text{ ft}) \tan (90^\circ - 78^\circ)] \\
 &\quad + (65 \text{ lb/ft}) [(0.97 \text{ ft}) + (0.333) (3.81 \text{ ft}) \tan (90^\circ - 78^\circ)] \\
 &= 510 \text{ ft-lb/ft} \\
 &= (7,036 \text{ N/m}) [(0.149 \text{ m}) + (0.5) (1.16 \text{ m}) \tan (90^\circ - 78^\circ)] \\
 &\quad + (954 \text{ N/m}) [(0.3 \text{ m}) + (0.333) (1.16 \text{ m}) \tan (90^\circ - 78^\circ)] \\
 &= 2,280 \text{ N-m/m}
 \end{aligned}$$

(NOTE: The quantities $(0.5) (H) \tan (90^\circ - \beta)$ and $(0.333) (H) \tan (90^\circ - \beta)$ account for the distance added to the moment arms because the wall is not vertical.)

The horizontal component of the active force is the only force that contributes to the overturning moment. The active force is the resultant of the active pressure distribution, which is triangular. For triangular pressure distributions, the vertical centroid is located at one-third the height of the triangle. Therefore, the horizontal component of the active force acts on the wall $(0.333) H$ from the bottom of the wall, where $y_1 = 1/3H$. The moment causing overturning is given by:

$$\begin{aligned}
 M_o &= (F_h) (y_1) = (F_h) (0.333) (H) \\
 &= (179 \text{ lb/ft}) (0.333) (3.81 \text{ ft}) = 227 \text{ ft-lb/ft} \\
 &= (2,620 \text{ N/m}) (0.333) (1.16 \text{ m}) = 1,012 \text{ N-m/m}
 \end{aligned}$$

The safety factor against overturning is:

$$\begin{aligned}
 \text{SFO} &= \frac{(\text{Moment resisting overturning})}{(\text{Moment causing overturning})} = \frac{M_r}{M_o} \\
 &= \frac{(510 \text{ ft-lb/ft})}{(227 \text{ ft-lb/ft})} = 2.2 \geq 2.0 \text{ OK} \\
 &= \frac{(2,280 \text{ N-m/m})}{(1,012 \text{ N-m/m})} = 2.2 \geq 2.0 \text{ OK}
 \end{aligned}$$

The safety factor against overturning is greater than 2.0. Therefore, the wall is stable and doesn't require geogrid reinforcement to prevent overturning. As calculated previously, the safety factor against sliding is also greater than 1.5 for this wall. This wall is adequate in both sliding and overturning and no geogrid reinforcement is required.

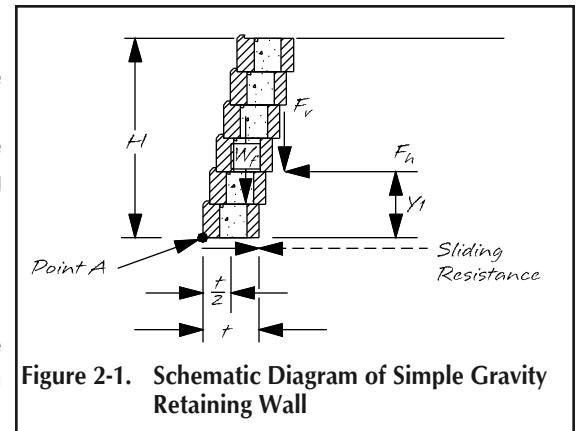
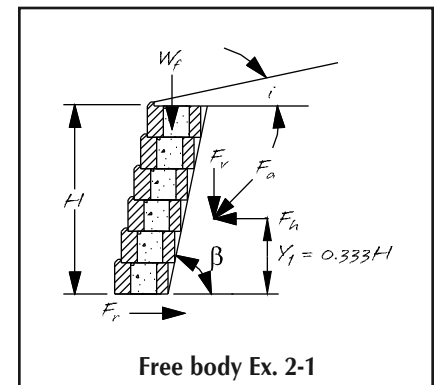
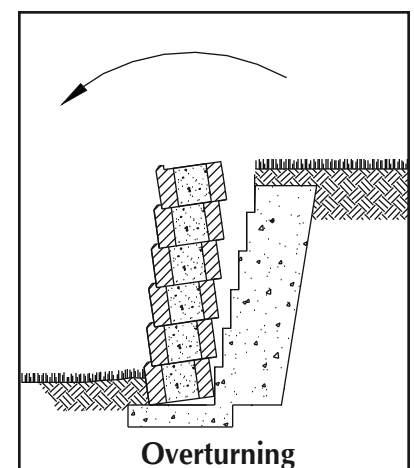

Figure 2-1. Schematic Diagram of Simple Gravity Retaining Wall



Free body Ex. 2-1



Overturning

Tieback Walls

A simple gravity wall may be analyzed and found to be unstable in either sliding or overturning. When this occurs, one possible solution is to analyze the wall with soil nails or earth anchors behind it. The soil nail or earth anchor is treated as a restraining device or anchor. The force on the wall due to the weight of the retained soil is calculated exactly as it was in the simple gravity wall analysis. However, the forces resisting failure in this instance are the frictional resistance due to the weight of the wall plus the friction force due to the weight of the soil on the grid or restraining force of the anchor. Figure 2-2 is a schematic diagram of a tieback wall.

Example 2-2: (9 course wall)

Given:

$$\begin{aligned} \phi &= 30^\circ & \phi_w &= 20^\circ \\ K_a &= 0.2197 & H &= 5.72 \text{ ft} \quad (1.74 \text{ m}) \\ \beta &= 78^\circ & \gamma &= 120 \text{ lb/ft}^3 \quad (1,923 \text{ kg/m}^3) \\ i &= 0^\circ & \gamma_{\text{wall}} &= 130 \text{ lb/ft}^3 \quad (2,061 \text{ kg/m}^3) \end{aligned}$$

Find: The safety factors against sliding, SFS, and overturning, SFO.

The first step is to analyze this wall without grid:

$$\begin{aligned} W_f &= (5.72 \text{ ft}) (0.97 \text{ ft}) (130 \text{ lb/ft}^3) = 721 \text{ lb/ft} \\ &= (1.74 \text{ m}) (0.3 \text{ m}) (2,061 \text{ kg/m}^3) (9.81 \text{ m/sec}^2) = 10,554 \text{ N/m} \end{aligned}$$

Next, the active force of the soil on the wall is calculated:

$$\begin{aligned} F_a &= (0.5) (120 \text{ lb/ft}^3) (0.2197) (5.72 \text{ ft})^2 = 431 \text{ lb/ft} \\ &= (0.5) (1,923 \text{ kg/m}^3) (0.2197) (1.74 \text{ m})^2 (9.81 \text{ m/sec}^2) = 6,074 \text{ N/m} \end{aligned}$$

The horizontal and vertical components of the active force are:

$$\begin{aligned} F_h &= (431 \text{ lb/ft}) \cos(20^\circ) = 405 \text{ lb/ft} \\ &= (6,274 \text{ N/m}) \cos(20^\circ) = 5,896 \text{ N/m} \\ F_v &= (431 \text{ lb/ft}) \sin(20^\circ) = 147 \text{ lb/ft} \\ &= (6,274 \text{ N/m}) \sin(20^\circ) = 2,146 \text{ N/m} \end{aligned}$$

The total vertical force due to the weight of the wall and the vertical component of the active force is:

$$\begin{aligned} V_t &= W_f + F_v \\ &= 721 \text{ lb/ft} + 147 \text{ lb/ft} \\ &= 868 \text{ lb/ft} \\ &= 10,554 \text{ N/m} + 2,146 \text{ N/m} \\ &= 12,700 \text{ N/m} \end{aligned}$$

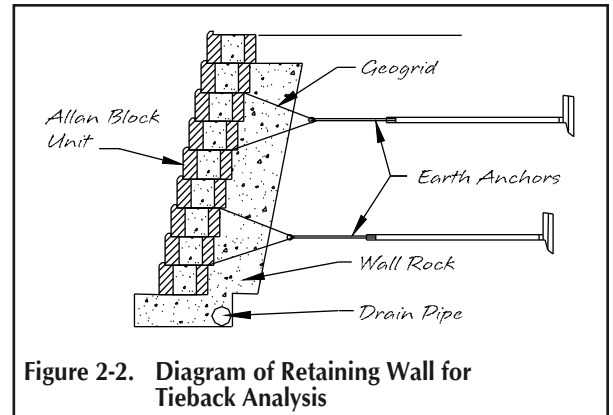

Figure 2-2. Diagram of Retaining Wall for Tieback Analysis

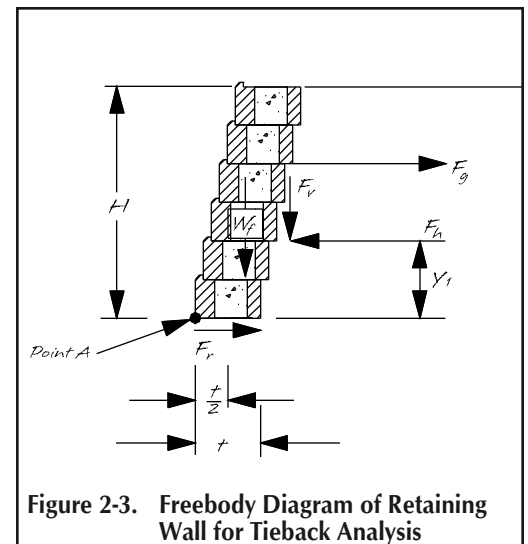

Figure 2-3. Freebody Diagram of Retaining Wall for Tieback Analysis

The force that resists sliding of the wall because of friction between the wall and the soil is:

$$\begin{aligned}
 F_r &= (V_t) (C_f) \\
 &= (868 \text{ lb/ft}) \tan (30^\circ) \\
 &= 501 \text{ lb/ft} \\
 &= (12,700 \text{ N/m}) \tan (30^\circ) \\
 &= 7,332 \text{ N/m}
 \end{aligned}$$

The safety factor against sliding is:

$$\begin{aligned}
 \text{SFS} &= \frac{F_r}{F_h} = \frac{(501 \text{ lb/ft})}{(405 \text{ lb/ft})} = 1.24 \leq 1.5 \\
 &= \frac{F_r}{F_h} = \frac{(7,332 \text{ N/m})}{(5,896 \text{ N/m})} = 1.24 \leq 1.5
 \end{aligned}$$

The safety factor against overturning is:

$$\begin{aligned}
 M_r &= (W_f) [(t/2) + (0.5) (H) \tan (90^\circ - \beta)] + (F_v) [(t) + (0.333) (H) \tan (90^\circ - \beta)] \\
 &= (721 \text{ lb/ft}) [(0.49 \text{ ft}) + (0.5) (5.72 \text{ ft}) \tan (90^\circ - 78^\circ)] \\
 &\quad + (147 \text{ lb/ft}) [(0.97 \text{ ft}) + (0.333) (5.72 \text{ ft}) \tan (90^\circ - 78^\circ)] \\
 &= 994 \text{ ft-lb/ft} \\
 &= (10,554 \text{ N/m}) [(0.149 \text{ m}) + (0.5) (1.74 \text{ m}) \tan (90^\circ - 78^\circ)] \\
 &\quad + (2,146 \text{ N/m}) [(0.3 \text{ m}) + (0.333) (1.74 \text{ m}) \tan (90^\circ - 78^\circ)] \\
 &= 4,432 \text{ N-m/m}
 \end{aligned}$$

$$\begin{aligned}
 M_o &= (F_h) (y_1) \\
 &= (405 \text{ lb/ft}) (0.333) (5.72 \text{ ft}) \\
 &= 771 \text{ ft-lb/ft} \\
 &= (5,896 \text{ N/m}) (0.333) (1.74 \text{ m}) \\
 &= 3,416 \text{ N-m/m}
 \end{aligned}$$

$$\begin{aligned}
 \text{SFO} &= \frac{M_r}{M_o} = \frac{(994 \text{ ft-lb/ft})}{(771 \text{ ft-lb/ft})} = 1.29 \leq 2.0 \\
 &= \frac{M_r}{M_o} = \frac{(4,432 \text{ N-m/m})}{(3,416 \text{ N-m/m})} = 1.29 \leq 2.0
 \end{aligned}$$

Without reinforcement, this wall is not adequate with respect to either sliding failure or overturning failure.

Therefore, a tieback wall will be required. A good rule of thumb is to place the reinforcement as close as possible to halfway between the top and bottom of the wall.



Earth Anchors as a Tieback

A single row of earth anchors can be utilized to provide the additional tieback resistance. The earth anchors extend beyond the line of maximum tension and provide additional resistance to overturning and sliding. This additional force can be utilized in our calculations as follows:

$$F_e = 10,500 \text{ lbs.} = (4,763 \text{ kg})$$

where:

$$F_e = \text{Preloaded value of installed earth anchor.}$$

For design purposes, we will use a weighted value of $0.67 F_e$ for anchor capacity. For this example, we will specify spacing of anchors on 8 foot (2.44 m) centers and a block pullout capacity (F_{pa})* shown below (Diagram Ex.2-2). Therefore, the additional force resisting sliding is:

$$F_r = (W_f + F_v) \tan(30^\circ) = (721 \text{ lb/ft} + 147 \text{ lb/ft}) \tan(30^\circ) = 501 \text{ lb/ft} = (10,554 \text{ N/m} + 2,146 \text{ N/m}) \tan(30^\circ) = 7,332 \text{ N/m}$$

$$F_{we} = (0.67) F_e \div 8 \text{ ft} = 879 \text{ lb/ft} = (0.67) F_e \div (2.44 \text{ m}) = 12,830 \text{ N/m}$$

$$F_{gr} = \text{LTADS} = 1,322 \text{ lb/ft} = (19,300 \text{ N/m})$$

$$F_{pa}^* = 1,313 \text{ lb/ft} + \tan(8^\circ) \times N$$

$$= 1,313 \text{ lb/ft} + [0.141 \times 1.9 \text{ ft} (0.97 \text{ ft})(130 \text{ lb/ft}^3)] = 1,347 \text{ lb/ft}$$

$$= 19,160 \text{ N/m} + \tan(8^\circ) \times N$$

$$= 19,160 \text{ N/m} + [0.141 \times 0.58 \text{ m} (0.3\text{m})(2,082 \text{ N/m}^3)] = 19,211 \text{ N/m}$$

$$F_h = 405 \text{ lb/ft} = (5,896 \text{ N/m})$$

where:

F_r = The maximum frictional resistance to sliding.

F_{we} = Weighted design value of anchor.

F_{gr} = Restraining strength of the geogrid = LTADS.

N = Weight of facing above geogrid location.

F_{ga} = The least of F_{we} , F_{gr} , or F_{pa} .

F_{pa}^* = Pullout grid capacity generic value.
(See Table B-1, page 84 for actual capacity results)

The resulting factor of safety with one row of earth anchors is:

$$\text{SFS} = \frac{F_r + F_{ga}}{F_h} = \frac{(501 \text{ lb/ft} + 879 \text{ lb/ft})}{405 \text{ lb/ft}}$$

$$= 3.41 \geq 1.5 \text{ OK}$$

$$= \frac{(7,332 \text{ N/m} + 12,830 \text{ N/m})}{5,896 \text{ N/m}}$$

$$= 3.41 \geq 1.5 \text{ OK}$$

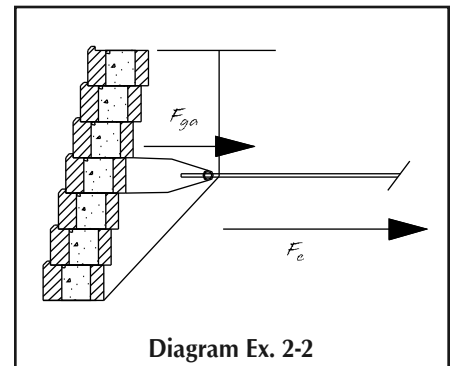

* F_{pa} is an example of a connection capacity equation determined using ASTM D6638 where 1313 lb/ft (19,160 N/m) represents the y-intercept, $\tan(8^\circ)$ represents the slope of the curve and N represents the normal load above the geogrid connection location.

The safety factor against overturning is:

$$\begin{aligned}
 M_r &= (W_f) [(t/2) + (0.5) (H) \tan (90^\circ - \beta)] + (F_v) [(t) + (0.333) (H) \tan (90^\circ - \beta)] + F_{ga} (H/2) \\
 &= (721 \text{ lb/ft}) [(0.49 \text{ ft}) + (0.5) (5.72 \text{ ft}) \tan (90^\circ - 78^\circ)] \\
 &+ (147 \text{ lb/ft}) [(0.97 \text{ ft}) + (0.333) (5.72 \text{ ft}) \tan (90^\circ - 78^\circ)] + (879 \text{ lb/ft}) (2.86 \text{ ft}) \\
 &= 3,507 \text{ ft-lb/ft} \\
 &= (10,554 \text{ N/m}) [(0.149 \text{ m}) + (0.5) (1.72 \text{ m}) \tan (90^\circ - 78^\circ)] \\
 &+ (2,146 \text{ N/m}) [(0.296 \text{ m}) + (0.333) (1.72 \text{ m}) \tan (90^\circ - 78^\circ)] + (12,830 \text{ N/m}) (0.86 \text{ m}) \\
 &= 15,432 \text{ N-m/m}
 \end{aligned}$$

$$\begin{aligned}
 \text{SFO} &= \frac{M_r}{M_o} = \frac{(3,507 \text{ ft-lb/ft})}{(771 \text{ ft-lb/ft})} = 4.5 \geq 2.0 \text{ OK} \\
 &= \frac{(15,432 \text{ N-m/m})}{(3,416 \text{ N-m/m})} = 4.5 > 2.0 \text{ OK}
 \end{aligned}$$

The anchor length requires a 3 ft (0.9 m) embedment into the passive zone. (Past the line of maximum tension)

$$\begin{aligned}
 L_t &= L_a + 3 \text{ ft} \\
 &= (5.72 \text{ ft} - 2.5 \text{ ft}) [\tan (30^\circ) - \tan (12^\circ)] + 3.0 \text{ ft} = 4.2 \text{ ft} \\
 &= (1.74 \text{ m} - 0.8 \text{ m}) [\tan (30^\circ) - \tan (12^\circ)] + 0.9 \text{ m} = 1.24 \text{ m}
 \end{aligned}$$

Where:

L_a = length of geogrid in the active zone

See page 27 for further discussion.

Check to determine if the F_{we} or the grid pullout from the block or rupture is the determining factor.

NOTE: The pullout from the block can be eliminated as the governing factor by bonding the block to grid interface with a grouted connection. However, the geogrid type will need to be specified to resist the high alkaline content of the concrete grout. See page 23 for further discussion of grid to block connection.

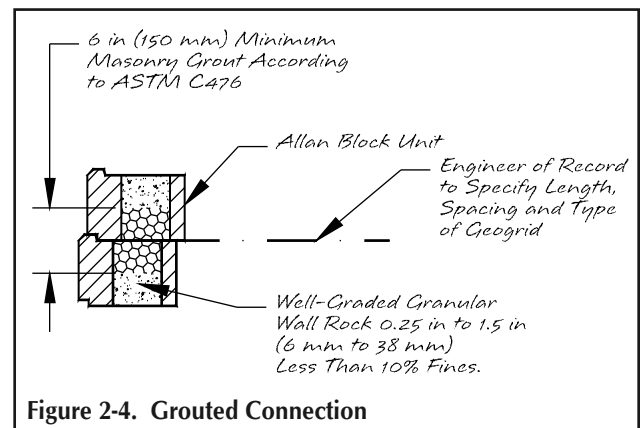

Coherent Gravity Walls

The theory behind coherent gravity walls is that two or more layers of geogrid make the reinforced soil mass behave as a single unit. The wall facing and reinforced soil mass are then treated as a unit and analyzed as a large simple gravity wall. The wall must be analyzed for stability in sliding and overturning. In addition, the number of layers of geogrid required, and their spacing, must be determined. Finally, the bearing pressure of such a large gravity wall must be checked to ensure that it doesn't exceed the allowable bearing capacity of the soil.

Example 2-3:

Figure 2-6 is a schematic diagram of a coherent gravity wall with seven layers of geogrid. Figure 2-8 is a freebody diagram of the same wall. The subscripts r and i refer to the retained soil and the infill soil, respectively. The values shown in Figure 2-6 will be used to analyze the stability of the wall. For this example use 6 ft (1.83 m) geogrid lengths (L_g).

Given: (15 course wall)

$$i = 0^\circ \text{ (Slope above wall)}$$

$$\phi_{wi} = 20^\circ$$

$$\phi_i = 30^\circ$$

$$K_{ai} = 0.2197$$

$$H = 9.52 \text{ ft (2.9 m)}$$

$$\phi_{wr} = 18^\circ$$

$$L_s = \text{Equivalent lip thickness of } 12^\circ \text{ AB Unit}$$

$$L_t = L_g + L_s$$

$$L_t = 6.0 + 0.13 = 6.13 \text{ ft (1.87 m)}$$

$$\phi_r = 27^\circ$$

$$\beta = 78^\circ$$

$$K_{ar} = 0.2561$$

$$\gamma_r = 120 \text{ lb/ft}^3 \text{ (1,923 kg/m}^3\text{)}$$

$$\gamma_i = 125 \text{ lb/ft}^3 \text{ (2,002 kg/m}^3\text{)}$$

Find: The safety factors against sliding, SFS, and overturning, SFO.

Length of Geogrid

Typically, the first step in analyzing the stability of the wall is to estimate the length of geogrid required. A rule of thumb is that the minimum reinforcement length is 60% of the wall height. This 60% value is a common industry standard.

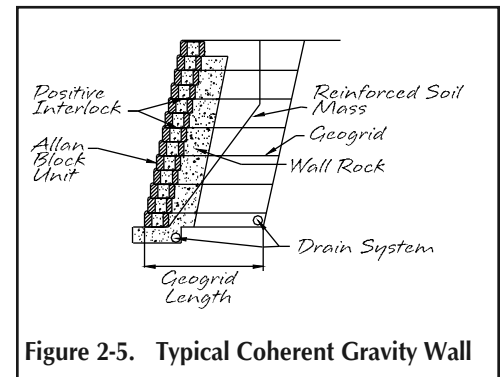

Figure 2-5. Typical Coherent Gravity Wall

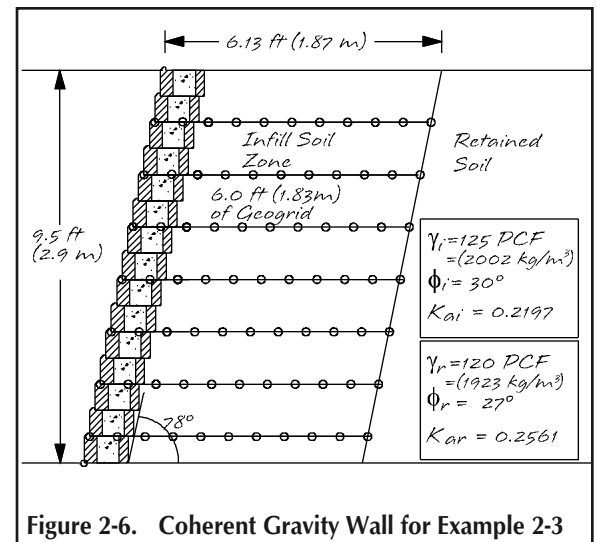

Figure 2-6. Coherent Gravity Wall for Example 2-3

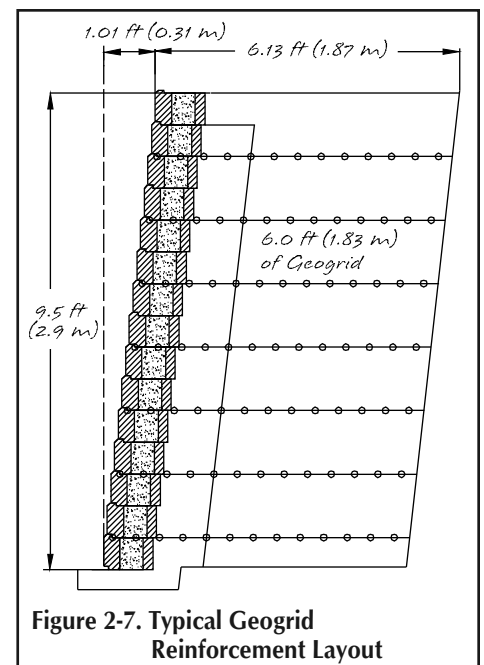

Figure 2-7. Typical Geogrid Reinforcement Layout

External Stability

Once the length of the geogrid is known, the weight of the coherent gravity wall can be calculated. The weight of the structure is the sum of the weights of the wall facing and the reinforced soil mass. The weight of the wall facing is equal to the unit weight of the wall facing times the height times the depth:

$$\begin{aligned} W_f &= (130 \text{ lb/ft}^3) (9.52 \text{ ft}) (0.97 \text{ ft}) = 1,200 \text{ lb/ft} \\ &= (2,061 \text{ kg/m}^3) (2.9 \text{ m}) (0.3 \text{ m}) (9.81 \text{ m/sec}^2) = 17,590 \text{ N/m} \end{aligned}$$

The weight of the reinforced soil mass is equal to the unit weight of the backfill soil, times the height of the reinforced soil mass, times the depth (measured from back face of wall to the end of the geogrid):

$$\begin{aligned} W_s &= (125 \text{ lb/ft}^3) (9.52 \text{ ft}) (6.0 \text{ ft} - 0.84 \text{ ft}) = 6,140 \text{ lb/ft} \\ &= (2,002 \text{ kg/m}^3) (2.9 \text{ m}) (1.83 \text{ m} - 0.256 \text{ m}) (9.81 \text{ m/sec}^2) = 89,647 \text{ N/m} \end{aligned}$$

The total weight of the coherent gravity wall is:

$$\begin{aligned} W_w &= W_f + W_s \\ &= (1,200 \text{ lb/ft}) + (6,140 \text{ lb/ft}) = 7,340 \text{ lb/ft} \qquad = (17,590 \text{ N/m}) + (89,647 \text{ N/m}) = 107,237 \text{ N/m} \end{aligned}$$

The next step is to calculate the active force on the gravity wall. The properties of the retained soil are used to calculate the active force since it acts at the back of the reinforced soil zone. The active force is given by the equation:

$$\begin{aligned} F_a &= (0.5) (\gamma_r) (K_{ar}) (H)^2 \\ &= (0.5) (120 \text{ lb/ft}^3) (0.2561) (9.52 \text{ ft})^2 \\ &= 1,393 \text{ lb/ft} \\ &= (0.5) (1,923 \text{ kg/m}^3) (0.2561) (2.9 \text{ m})^2 (9.81 \text{ m/sec}^2) \\ &= 20,315 \text{ N/m} \end{aligned}$$

The horizontal and vertical components of the active force are:

$$\begin{aligned} F_h &= (F_a) \cos (\phi_{wr}) \\ &= (1,393 \text{ lb/ft}) \cos (18^\circ) \qquad = (20,315 \text{ N/m}) \cos (18^\circ) \\ &= 1,325 \text{ lb/ft} \qquad \qquad \qquad = 19,321 \text{ N/m} \\ F_v &= (F_a) \sin (\phi_{wr}) \\ &= (1,393 \text{ lb/ft}) \sin (18^\circ) \qquad = (20,315 \text{ N/m}) \sin (18^\circ) \\ &= 430 \text{ lb/ft} \qquad \qquad \qquad = 6,278 \text{ N/m} \end{aligned}$$

Next, the total vertical force is calculated:

$$\begin{aligned} V_t &= W_w + F_v \\ &= (7,340 \text{ lb/ft}) + (430 \text{ lb/ft}) = 7,770 \text{ lb/ft} \qquad = (107,237 \text{ N/m}) + (6,278 \text{ N/m}) = 113,515 \text{ N/m} \end{aligned}$$

The force resisting sliding is calculated by multiplying the total vertical force by the coefficient of friction between the reinforced soil mass and the underlying soil:

$$\begin{aligned} F_r &= (V_t) (C_f) \\ &= (7,770 \text{ lb/ft}) \tan (30^\circ) = 4,486 \text{ lb/ft} \qquad = (113,515 \text{ N/m}) \tan (30^\circ) = 65,538 \text{ N/m} \end{aligned}$$

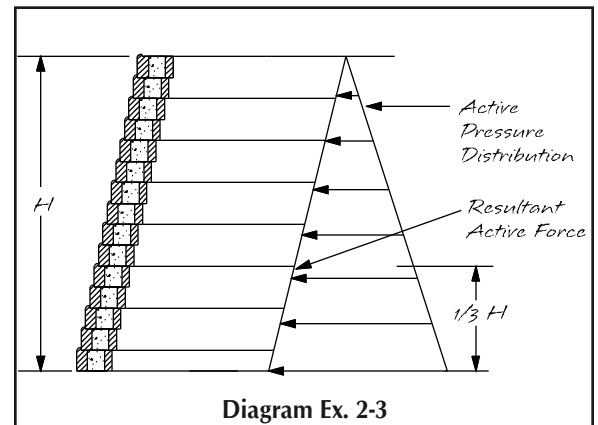

Diagram Ex. 2-3

The safety factor against sliding is:

$$\text{SFS} = \frac{F_r}{F_h} = \frac{(4,486 \text{ lb/ft})}{(1,325 \text{ lb/ft})} = 3.45 \geq 1.5 \text{ OK}$$

$$= \frac{F_r}{F_h} = \frac{(65,538 \text{ N/m})}{(19,321 \text{ N/m})} = 3.4 \geq 1.5 \text{ OK}$$

The safety factor against overturning is:

(NOTE: All moments are taken about Point A in Figure 2-8.)

$$\begin{aligned} \Sigma M_r &= (W_f) [(0.5) (t) + (0.5) (H) \tan (90^\circ - \beta)] \\ &+ (W_s) [(0.5) (L_t - t) + (t) + (0.5) (H) \tan (90^\circ - \beta)] \\ &+ (F_v) [(L_t) + (0.333) (H) \tan (90^\circ - \beta)] \\ &= (1,200 \text{ lb/ft}) [(0.5) (0.97 \text{ ft}) + (0.5) (9.52 \text{ ft}) \tan (90^\circ - 78^\circ)] \\ &+ (6,140 \text{ lb/ft}) [(0.5) (6.13 \text{ ft} - 0.97 \text{ ft}) + (0.97 \text{ ft}) + (0.5) (9.52 \text{ ft}) \tan (90^\circ - 78^\circ)] \\ &+ (430 \text{ lb/ft}) [(6.13 \text{ ft}) + (0.333) (9.52 \text{ ft}) \tan (90^\circ - 78^\circ)] \\ &= 32,731 \text{ ft-lb/ft} \end{aligned}$$

$$\begin{aligned} &= (17,590 \text{ N/m}) [(0.5) (0.3 \text{ m}) + (0.5) (2.9 \text{ m}) \tan (90^\circ - 78^\circ)] \\ &+ (89,647 \text{ N/m}) [(0.5) (1.87 \text{ m} - 0.3 \text{ m}) + (0.3 \text{ m}) + (0.5) (2.9 \text{ m}) \tan (90^\circ - 78^\circ)] \\ &+ (6,278 \text{ N/m}) [(1.87 \text{ m}) + (0.333) (2.9 \text{ m}) \tan (90^\circ - 78^\circ)] \\ &= 145,985 \text{ N-m/m} \end{aligned}$$

$$\begin{aligned} \Sigma M_o &= (F_h) (0.333) (H) \\ &= (1,325 \text{ lb/ft}) (0.333) (9.52 \text{ ft}) \\ &= 4,200 \text{ ft-lb/ft} \\ &= (19,321 \text{ N/m}) (0.333) (2.9 \text{ m}) \\ &= 18,658 \text{ N-m/m} \end{aligned}$$

$$\text{SFO} = \frac{\Sigma M_r}{\Sigma M_o} = \frac{(32,731 \text{ ft-lb/ft})}{(4,200 \text{ ft-lb/ft})} = 7.8 \geq 2.0 \text{ OK}$$

$$= \frac{\Sigma M_r}{\Sigma M_o} = \frac{(145,985 \text{ N-m/m})}{(18,658 \text{ N-m/m})} = 7.8 \geq 2.0 \text{ OK}$$

The minimum recommended safety factors for geogrid reinforced retaining walls are 1.5 for sliding failure and 2.0 for overturning failure. Since both safety factors for this wall exceed the minimum values, the wall is adequate with respect to sliding and overturning. In cases where either of the safety factors is lower than required, the length of geogrid is increased and the analysis is repeated. The process ends when both safety factors exceed the minimum recommended values.

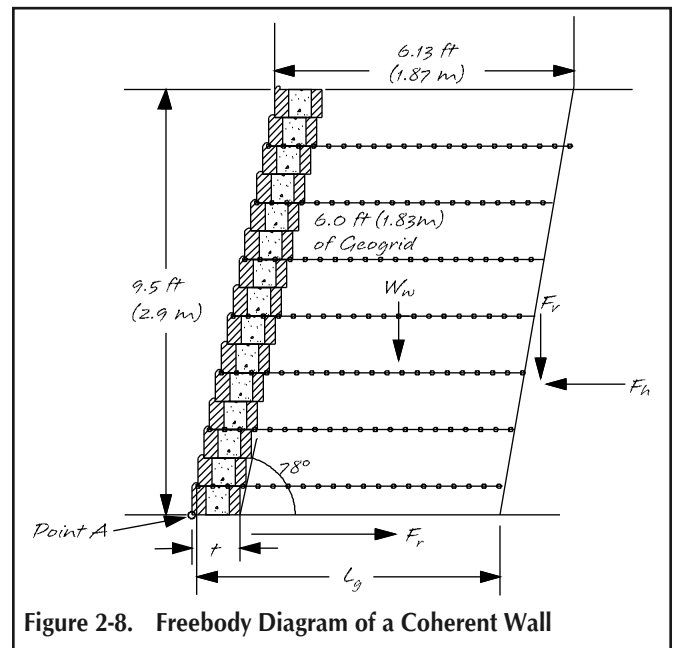

Figure 2-8. Freebody Diagram of a Coherent Wall

Bearing Pressure on the Underlying Soil

Another consideration in the design of a coherent gravity wall is the ability of the underlying soil to support the weight of a giant gravity wall. Most undisturbed soils can withstand pressures between 2,500 (120 kPa) and 4,000 (192 kPa) pounds per square foot.

Figure 2-9 is a freebody diagram of the coherent gravity wall in Example 2-3. It shows the forces acting on the wall. With this information, the maximum bearing pressure can be calculated and compared to the allowable bearing pressure.

The first step is to calculate the resultant vertical resisting force, F_{vb} , exerted on the gravity wall by the soil:

$$\begin{aligned} F_{vb} &= \sum F_y = W_w + F_v \\ &= (7,340 \text{ lb/ft} + 430 \text{ lb/ft}) &&= 107,237 \text{ N/m} + 6,278 \text{ N/m} \\ &= 7,770 \text{ lb/ft} &&= 113,515 \text{ N/m} \end{aligned}$$

The next step is to locate the point of application of the resultant force. This is done by summing moments around Point A, setting the result equal to zero, and solving for X.

$$\begin{aligned} \sum M_A &= (F_{vb})(X) + (F_h)(1/3 H) - W_w(4.04 \text{ ft} - F_v[6.13 \text{ ft} + H/3 \tan(90^\circ - 78^\circ)]) \\ &= (7,770 \text{ lb/ft})(X) + (1,325 \text{ lb/ft})(3.17 \text{ ft}) \\ &\quad - (7,340 \text{ lb/ft})(4.04 \text{ ft}) - (430 \text{ lb/ft})(6.80 \text{ ft}) \\ X &= \frac{(29,654 \text{ ft-lb/ft}) + (2,924 \text{ ft-lb/ft}) - (4,200 \text{ ft-lb/ft})}{(7,770 \text{ lb/ft})} = 3.65 \text{ ft} \\ &= \frac{(113,515 \text{ N/m})(X) + (19,321 \text{ N-m})(0.966 \text{ m})}{(113,515 \text{ N/m})} \\ &\quad - (107,237 \text{ N-m})(1.23 \text{ m}) - (6,278 \text{ N-m})[1.87 \text{ m} + H/3 \tan(90^\circ - 78^\circ)] \\ &= \frac{(131,902 \text{ N-m/m}) + (13,028 \text{ N-m/m}) - (18,664 \text{ N-m/m})}{(113,515 \text{ N/m})} = 1.11 \text{ m} \end{aligned}$$

The eccentricity, e, of the resultant vertical force, is the distance from the centerline of bearing of the gravity wall to the point of application of the resultant force, F_{vb} . In this case:

$$\begin{aligned} e &= (0.5)(L_t) - X \\ &= (0.5)(6.13 \text{ ft}) - X &&= (0.5)(1.87 \text{ m}) - X \\ &= (0.5)(6.13 \text{ ft}) - 3.65 \text{ ft} = -0.59 \text{ ft} &&= (0.5)(1.87 \text{ m}) - 1.11 \text{ m} = -0.165 \text{ m} \end{aligned}$$

In this case the eccentricity is negative. A negative eccentricity means that the wall mass is rolling backwards, thus causing a decrease in bearing pressure at the toe. Since this is not practical, "e" shall always be conservatively taken as greater than or equal to zero.

$$e = 0 \text{ ft} \quad = 0 \text{ m}$$

Assuming a linear bearing pressure distribution, the average bearing pressure occurs at the centerline of the wall. Its magnitude is:

$$\sigma_{avg} = \frac{F_{vb}}{L_t} = \frac{(7,770 \text{ lb/ft})}{(6.13 \text{ ft})} = 1,268 \text{ lb/sq ft} \quad = \frac{F_{vb}}{L_t} = \frac{113,515 \text{ N/m}}{1.87 \text{ m}} = 61 \text{ kPa}$$

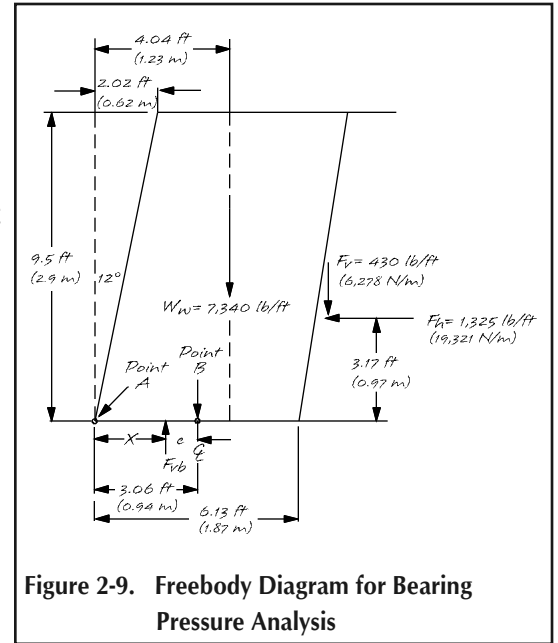

Figure 2-9. Freebody Diagram for Bearing Pressure Analysis

Next, the bearing pressure due to the moment about the centerline of bearing is calculated. This is done by finding the moment due to the resultant vertical force about the centerline of bearing (Point B) and dividing it by the section modulus of a horizontal section through gravity wall. The moment due to the eccentricity of the resultant vertical force is:

$$\begin{aligned} M_B &= (F_{vb})(e) \\ &= (7,770 \text{ lb/ft})(0 \text{ ft}) &= (113,515 \text{ N/m})(0 \text{ m}) \\ &= 0 \text{ ft-lb/ft} &= 0 \text{ N-m/m} \end{aligned}$$

The section modulus of a 1-foot or 1-meter wide section of the wall is given by:

$$S = \frac{(l)(L_t)^2}{6}$$

Where:

$$\begin{aligned} l &= \text{the width of the section} = 1.0 \text{ ft or } 1 \text{ m} \\ L_t &= \text{the depth of the section} = L_t = 6.13 \text{ ft } (1.87 \text{ m}) \\ S &= \frac{(1 \text{ ft})(6.13 \text{ ft})^2}{6(1 \text{ ft})} &= \frac{(1.0 \text{ m})(1.87 \text{ m})^2}{6(1 \text{ m})} \\ &= 6.26 \frac{\text{ft}^3}{\text{ft}} &= 0.583 \frac{\text{m}^3}{\text{m}} \end{aligned}$$

The difference in stress due to the eccentricity is:

$$\begin{aligned} \sigma_{\text{mom}} &= \frac{M_B}{S} \\ &= \frac{(0 \text{ ft-lb/ft})(\text{ft})}{(6.26 \text{ ft}^3)} &= \frac{(0 \text{ N-m/m})(\text{m})}{(0.583 \text{ m}^3)(1000)} \\ &= 0 \text{ lb/ft}^2 &= 0 \text{ kPa} \end{aligned}$$

Finally, the maximum and minimum bearing pressures are calculated:

$$\begin{aligned} \sigma &= \sigma_{\text{avg}} \pm \sigma_{\text{mom}} \\ \sigma_{\text{max}} &= \sigma_{\text{avg}} + \sigma_{\text{mom}} \\ &= (1,268 \text{ lb/sq ft}) + (0 \text{ lb/sq ft}) &= (61 \text{ kPa}) + (0 \text{ kPa}) \\ &= 1,268 \text{ lb/sq ft} &= 61 \text{ kPa} = 6,100 \text{ kg/m}^2 \\ \sigma_{\text{min}} &= \sigma_{\text{avg}} - \sigma_{\text{mom}} \\ &= (1,268 \text{ lb/sq ft}) - (0 \text{ lb/sq ft}) &= (61 \text{ kPa}) - (0 \text{ kPa}) \\ &= 1,268 \text{ lb/sq ft} &= 61 \text{ kPa} = 6,100 \text{ kg/m}^2 \end{aligned}$$

If the maximum bearing pressure was greater than the allowable bearing pressure of 2,500 lb/sq ft (120 kPa), the wall would be unstable with respect to the allowable bearing capacity of the underlying soil.

The procedure outlined above can be simplified by rearranging the equations as follows:

$$\begin{aligned} \sigma &= \sigma_{\text{avg}} \pm \sigma_{\text{mom}} \\ \sigma &= \frac{F_{vb}}{L_t} \pm \frac{M_b}{S} = \frac{F_{vb}}{L_t} \pm \frac{(6)M_b}{L_t^2} = \frac{F_{vb}}{L_t} \pm \frac{(6)(F_{vb})(e)}{L_t^2} \end{aligned}$$

When the maximum bearing pressure is greater than the allowable bearing pressure the underlying soil is not stable. Stabilizing the soil under the wall is accomplished by spreading the forces of the wall over a larger area. Engineers use this concept in designing spread footings.

Once the σ_{max} is determined, compare it to ultimate bearing capacity (q_f) as defined by Terzaghi:

$$q_f = (1/2) (\gamma_f) (B_b) (N_\gamma) + (c) (N_c) + (\gamma_f) (D) (N_q)$$

(Craig, p. 303, Soil Mechanics, Fifth Edition)

Where:

- N_q = Contribution due to entire pressure (Terzaghi's value)
- N_c = Contribution due to constant component of shear strength (Terzaghi's value)
- N_γ = Contribution from self weight of the soil (Meyerhof's value)
- N_q = $\exp (\pi \tan \phi_f) \tan^2 (45 + \phi_f/2)$
- N_c = $(N_q - 1) \cot \phi_f$
- N_γ = $(N_q - 1) \tan (1.4\phi_f)$
- γ_f = Unit weight of foundation soils
- D = Depth of wall embedment
- D = Buried block + footing thickness (d_b).
- c = Cohesion of foundation soils
- B_b = Width of the foundation
- ϕ_f = Friction angle of foundation soils

NOTE: The Terzaghi values do not take into account the rectangular footing and eccentric loads. Using the Meyerhof equations to modify these parameters will include these affects.

The ultimate bearing (q_f) should be designed to a factor of safety of 2.0

If $SFB = \frac{q_f}{\sigma_{max}} < 2.0$, then increase the size of the base until factor of safety is achieved.

The material in the base will usually be a select gravel, $\phi_B = 36^\circ$. However, the foundation soil below the base material is native soil and assume for this example to be $\phi_f = 30^\circ$. Assume a 0.5 ft (0.15 m) increase in base depth. The base width will increase by twice the following:

$$\tan (45 + \phi/2) = 0.5 \text{ ft}/W$$

$$W = 0.5 \text{ ft} / \tan (45 - 30^\circ/2)$$

$$W = 0.29 \text{ ft} \text{ use } 0.33 \text{ ft}$$

$$\tan (45 + \phi/2) = 0.15 \text{ m}/W$$

$$W = 0.15 \text{ m} / \tan (45 - 30^\circ/2)$$

$$W = 0.08 \text{ m} \text{ use } 0.1 \text{ m}$$

Therefore, the incremental base size is:

$$\text{Depth } (d_i) = d_b + 0.5 \text{ ft}$$

$$= d_b + 0.15 \text{ m}$$

$$\text{Width } (B_i) = B_b + (2) (W)$$

$$= B_b + (2) (0.33 \text{ ft})$$

$$= B_b + (2) (0.1 \text{ m})$$

Typical installation would center wall facing units on base width.

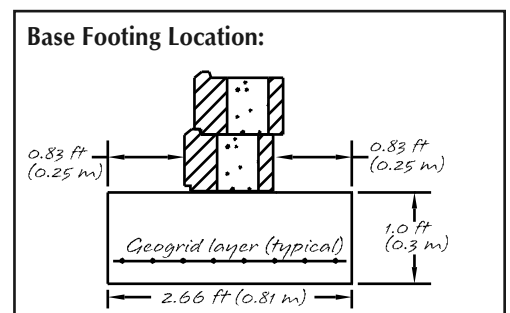
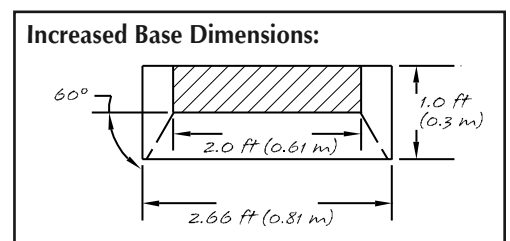
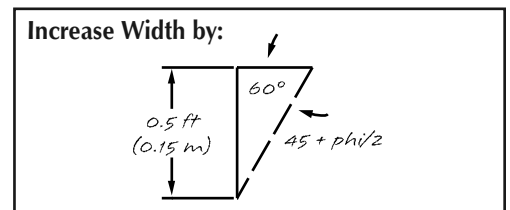
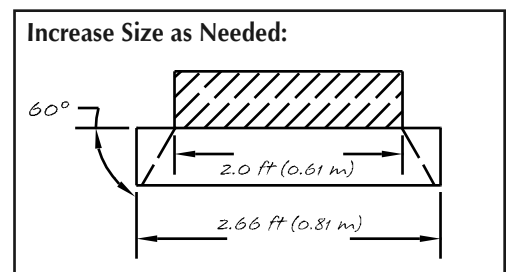
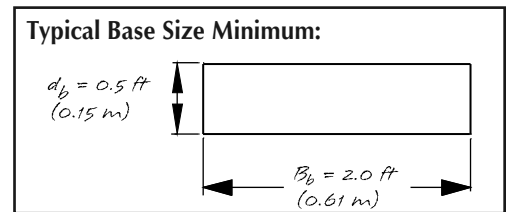

Internal Stability

Allan Block recommends no more than 2-course spacing -16 in. (406 mm) - between each layer of geogrid reinforcement for any Allan Block system to ensure that the wall acts as a coherent mass.

The load on each layer of geogrid is equal to the average pressure on the wall section, P_{avg} , multiplied by the height of the section, d_h , (Figure 2-10). The pressure at any depth is given by:

$$P_v = (\gamma_i) (\text{depth}) (K_{ai}) \cos (\phi_{wi})$$

Internal Stability

Internal stability is the ability of the reinforcement combined with the internal strength of the soil to hold the soil mass together and work as a single unit.

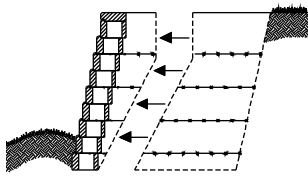

Grid Rupture

Rupture occurs when excessive forces from the retained soil mass exceed the ultimate tensile strength of the geogrid.

Increase grid strength

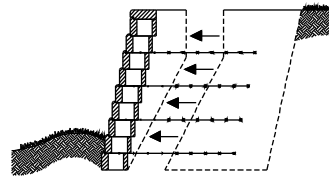

Pullout

Pullout results when grid layers are not embedded a sufficient distance beyond the line of maximum tension.

Increase embedment length

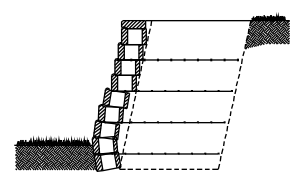

Bulging

Bulging occurs when horizontal forces between the geogrid layers causes localized rotation of the wall. Refer to Chapter Six for detailed analysis.

Increase number of grid layers

The load on each layer of grid is given by:

$$F_g = (P_{avg}) (d_h)$$

where:

$$\begin{aligned} P_{avg} &= (0.5) (P_{base} + P_{top}) \\ &= (0.5) [(\gamma_i) (d_1) (K_{ai}) \cos (\phi_{wi}) \\ &\quad + (\gamma_i) (d_2) (K_{ai}) \cos (\phi_{wi})] \\ &= (0.5) (\gamma_i) (K_{ai}) \cos (\phi_{wi}) (d_1 + d_2) \end{aligned}$$

$$d_h = d_1 - d_2$$

d_1 = distance from the top of the backfill to the bottom of the zone supported by the layer of geogrid.

d_2 = distance from the top of the backfill to the top of the zone supported by the layer of geogrid.

Geogrid can only be placed between the blocks forming the wall facing. That means that the geogrid can only be placed at heights evenly divisible by the block height, this example is 7.62 inches or 0.635 ft (194 mm).

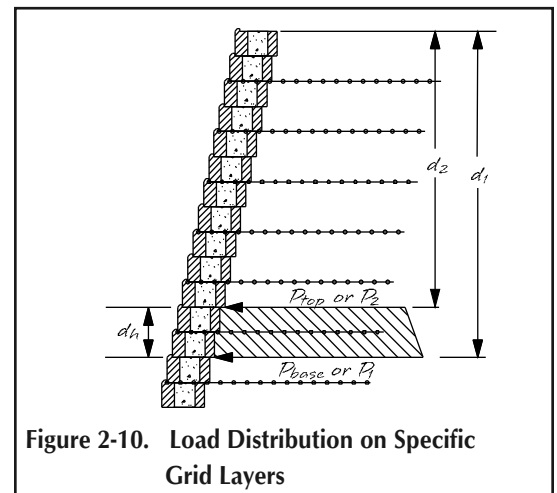
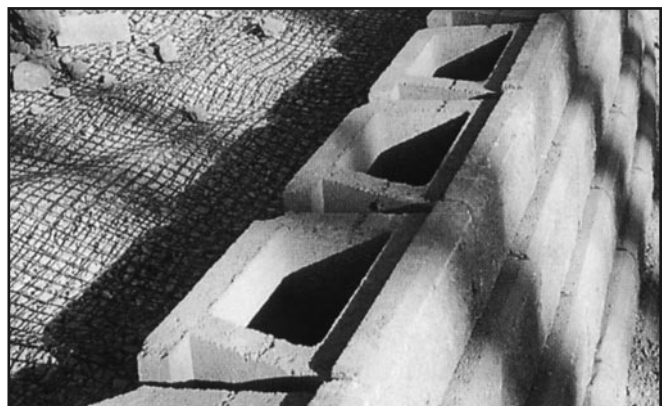

Figure 2-10. Load Distribution on Specific Grid Layers



Attachment of the Geogrid to the Wall Facing

A logical question to ask is: What keeps the geogrid from slipping out from between the courses of Allan Block? The answer is that the weight of the Allan Blocks sitting on top of the geogrid creates friction between the blocks and the geogrid. In addition, some of the material used to fill the voids in the Allan Blocks becomes wedged in the apertures of the geogrid. This is called *Rock-Lock* and results in additional resistance to sliding.

Allan Block's original pullout tests were conducted in 1989 at the University of Wisconsin-Platteville by Kliethermes, et al. Two sets of tests were run. In the first set, the voids of the Allan Blocks were filled with gravel. In the second set, the voids were left empty.

When the voids were filled with gravel, there was an apparent *coefficient of friction* (ACF) of about 3.0 between the geogrid and the Allan Blocks. When the voids were left empty, the ACF was about 0.88. The surprising magnitude of the ACF for gravel is due to a significant amount of interlocking between the gravel and the geogrid.

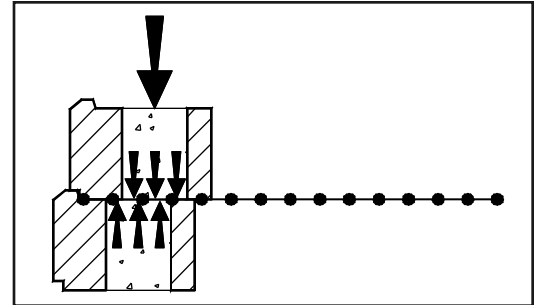

The hollow core, pinless design of Allan Block raises questions on how the geogrid is attached to the wall facing. Allan Block's gravel filled hollow core provides a multi-point interlock with the grid. As wall heights increase, our exclusive "rock lock" connection, combined with the weight of the Allan Block units, provides a more uniform block-to-grid interlock than any system on the market.

Allan Block had additional pullout tests conducted at the University of Washington in 1993-1994. A total of ten geogrids and two geofabrics were tested. Each product was tested three times under four loading conditions; 500 lbs. (226.8 kg), 1000 lbs. (453.6 kg), 1500 lbs. (680.4 kg), and 2000 lbs. (907.18 kg) vertical load per lineal foot of wall. The data compiled was consistent. From a total of 144 pullout tests, the results exhibited a uniform behavior based on grid strengths and normal loads applied. The test values increased with added vertical loads. A typical pullout equation for service and ultimate loads takes the form $X + Y * N$. The variables X and Y are constant values as determined by testing. The normal (vertical) load N , is load applied to the block. The location of the block to grid connection will be the determining factor for the amount of normal (vertical) load applied. Appendix B has a thorough discussion on the current ASTM connection methodology and a complete table of current tested connection values with a large variety of geogrids.

The maximum force in the geogrid occurs at the Line of Maximum Tension - the boundary between the active and passive zones of the retained soil. The force on the geogrid decreases as the horizontal distance from the failure plane increases. At the back of the wall, the force on the geogrid is reduced to about two-thirds of the maximum force (McKittrick, 1979). As a result there is a 0.667 reduction factor for the load at the face (RF_{LF}).

The static geogrid/block connection capacity factor of safety is determined by comparing the peak connection strength, which is a function of the normal load, to the applied load on each layer of geogrid. Find the factors of safety for the static geogrid/block connection capacity:

$$SF_{\text{conn}} = \frac{F_{\text{CS}}}{(F_{\text{gTopLayer}}) (RF_{\text{LF}})} \geq 1.5$$

The peak connection strength (F_{CS}) is an equation of a line generated by comparing the maximum pullout force under various normal loads. The numbers in this example are generic that show approximated values. Actual geogrid testing properties can be found in Table B-1 on page 84. The resulting equation for F_{CS} is:

$$F_{\text{CS}} = 1,313 \text{ lb/ft} + \tan(8^\circ)(N) \quad = 19,204 \text{ N/m} + \tan(8^\circ)(N)$$

Where the normal load (N) is:

$$\begin{aligned} N &= (H - \text{grid elev}) (\gamma_{\text{wall}}) (t) \\ &= (9.52 \text{ ft} - 6.35 \text{ ft}) (130 \text{ lb/ft}^3) (0.97 \text{ ft}) &= (2.9 \text{ m} - 1.94 \text{ m}) (2,061 \text{ kg/m}^3) (0.30 \text{ m}) (9.81) \\ &= 400 \text{ lb/ft} &= (5,822 \text{ N/m}) \end{aligned}$$

Therefore, the peak connection strength (F_{CS}) is:

$$\begin{aligned} F_{\text{CS}} &= 1,313 \text{ lb/ft} + \tan(8^\circ) (400 \text{ lb/ft}) \\ &= 1,313 \text{ lb/ft} + 0.140 (85 \text{ lb/ft}) = 1,369 \text{ lb/ft} &= 19,204 \text{ N/m} + 0.140 (5,822 \text{ N/m}) = 20,019 \text{ N/m} \end{aligned}$$

$$\begin{aligned} SF_{\text{conn}} &= \frac{1,369 \text{ lb/ft}}{360 \text{ lb/ft} (0.667)} = 5.7 \geq 1.5 &= \frac{20,019 \text{ N/m}}{5,822 \text{ N/m}} = 5.7 \geq 1.5 \end{aligned}$$

Example 2-5a

Let's analyze the wall of Example 2-3 for geogrid pullout from blocks. Diagram Ex. 2-5a shows the wall and some of the dimensions that will be needed in the calculations. Calculate the horizontal force on the bottom layer of geogrid:

$$\begin{aligned}
 Ph_1 &= (\gamma_i) (K_{ai}) (d_1) (\cos \phi_{wi}) \\
 &= (125 \text{ lb/ft}^3) (0.2197) (9.52 \text{ ft}) (0.940) &= (2,002 \text{ kg/m}^3) (0.2197) (2.9 \text{ m}) (0.940) \\
 &= 246 \text{ lb/ft}^2 &= 1,200 \text{ kg/m}^2
 \end{aligned}$$

$$\begin{aligned}
 Ph_2 &= (\gamma_i) (K_{ai}) (d_2) (\cos \phi_{wi}) \\
 &= (125 \text{ lb/ft}^3) (0.2197) (8.25 \text{ ft}) (0.940) &= (2,002 \text{ kg/m}^3) (0.2197) (2.51 \text{ m}) (0.940) \\
 &= 213 \text{ lb/ft}^2 &= 1,038 \text{ kg/m}^2
 \end{aligned}$$

$$\begin{aligned}
 P_{\text{avg}} &= (0.5) (246 \text{ lb/ft}^2 + 213 \text{ lb/ft}^2) &= (0.5) (1,200 \text{ kg/m}^2 + 1,038 \text{ kg/m}^2) \\
 &= 230 \text{ lb/ft}^2 &= 1,119 \text{ kg/m}^2
 \end{aligned}$$

$$\begin{aligned}
 F_1 &= P_{\text{avg}} (d_h) \\
 &= (230 \text{ lb/ft}^2) (1.27 \text{ ft}) \\
 &= 292 \text{ lb/ft} \\
 &= (1,119 \text{ kg/m}^2) (0.39 \text{ m}) (9.81 \text{ m/sec}^2) \\
 &= 4,281 \text{ N/m}
 \end{aligned}$$

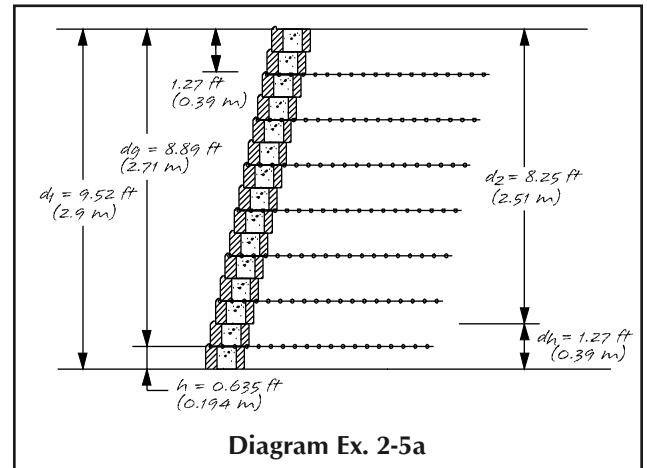

The force on the geogrid at the back face of the wall will be approximately two-thirds of F_1 :

$$\begin{aligned}
 F_w &= (0.667) (F_1) = (0.667) (292 \text{ lb/ft}) \\
 &= 195 \text{ lb/ft} \\
 &= (0.667) (F_1) = (0.667) (4,281 \text{ N/m}) \\
 &= 2,854 \text{ N/m}
 \end{aligned}$$

The normal load is:

$$\begin{aligned}
 N_1 &= (130 \text{ lb/ft}^3) (0.97 \text{ ft}) (8.89 \text{ ft}) = 1,121 \text{ lb/ft} \\
 &= (2,082 \text{ kg/m}^3) (0.3 \text{ m}) (2.71 \text{ m}) (9.81 \text{ m/sec}^2) = 16,605 \text{ N/m}
 \end{aligned}$$

Connection capacity equation:

$$\begin{aligned}
 F_{\text{CS}} &= 1,313 \text{ lb/ft} + \tan(8^\circ) (1,121 \text{ lb/ft}) \\
 &= 1,313 \text{ lb/ft} + 0.140 (1,121 \text{ lb/ft}) &= 19,204 \text{ N/m} + 0.140 (16,605 \text{ N/m}) \\
 &= 1,470 \text{ lb/ft} &= 21,529 \text{ N/m}
 \end{aligned}$$

The safety factor against pullout of block for the bottom layer of geogrid is:

$$\begin{aligned}
 SF_{\text{conn}} &= \frac{F_{\text{CS}}}{F_w} = \frac{(1,470 \text{ lb/ft})}{195 \text{ lb/ft}} = 7.5 \geq 1.5 &= \frac{(21,529 \text{ N/m})}{(2,854 \text{ N/m})} = 7.5 \geq 1.5
 \end{aligned}$$

Example 2-5b

The horizontal force on the top layer of geogrid is:

$$\begin{aligned}
 P_{h7} &= (\gamma) (K_a) (d_7) (\cos \phi_{wi}) = (125 \text{ lb/ft}^3) (0.2197) (1.91 \text{ ft}) (0.940) = 49 \text{ lb/ft}^2 \\
 &= (\gamma) (K_a) (d_7) (\cos \phi_{wi}) = (2,002 \text{ kg/m}^3) (0.2197) (0.58 \text{ m}) (0.940) = 240 \text{ kg/m}^2 \\
 P_{h8} &= (\gamma) (K_a) (d_8) (\cos \phi_{wi}) = (125 \text{ lb/ft}^3) (0.2197) (0 \text{ ft}) (0.940) = 0 \text{ lb/ft}^2 \\
 &= (\gamma) (K_a) (d_8) (\cos \phi_{wi}) = (2,002 \text{ kg/m}^3) (0.2197) (0 \text{ m}) (0.940) = 0 \text{ kg/m}^2 \\
 P_{avg} &= (0.5) (49 \text{ lb/ft}^2 + 0 \text{ lb/ft}^2) = 25 \text{ lb/ft}^2 = (0.5) (240 \text{ kg/m}^2 + 0 \text{ kg/m}^2) = 120 \text{ kg/m}^2 \\
 F_7 &= (P_{avg}) (d_h) = (25 \text{ lb/ft}^2) (1.91 \text{ ft}) = 47 \text{ lb/ft} \\
 &= (P_{avg}) (d_h) = (120 \text{ kg/m}^2) (0.58 \text{ m}) (9.81 \text{ m/sec}^2) = 683 \text{ N/m}
 \end{aligned}$$

The force on the geogrid at the back face of the wall will be approximately two-thirds of F_7 :

$$F_w = (0.667) (F_7) = (0.667) (47 \text{ lb/ft}) = 31 \text{ lb/ft} = (0.667) (F_7) = (0.667) (683 \text{ N/m}) = 455 \text{ N/m}$$

The force resisting pullout, caused by the weight of the aggregate filled blocks above the top geogrid layer, is:

$$\begin{aligned}
 N_7 &= (130 \text{ lb/ft}^3) (0.97 \text{ ft}) (1.27 \text{ ft}) = 160 \text{ lb/ft} = (2,082 \text{ kg/m}^3) (0.3 \text{ m}) (0.39 \text{ m}) (9.81 \text{ m/sec}^2) = 2,390 \text{ N/m} \\
 F_{cs} &= 1,313 \text{ lb/ft} + 0.140 (160 \text{ lb/ft}) = 1,335 \text{ lb/ft} = 19,204 \text{ N/m} + 0.140 (2,390 \text{ N/m}) = 19,539 \text{ N/m}
 \end{aligned}$$

The safety factor against pullout of block for the top layer of geogrid is:

$$\begin{aligned}
 SF_{conn} &= \frac{F_{cs}}{F_w} = \frac{(1,335 \text{ lb/ft})}{(31 \text{ lb/ft})} = 43.0 \geq 1.5 \\
 &= \frac{(19,539 \text{ N/m})}{(455 \text{ N/m})} = 43.0 \geq 1.5
 \end{aligned}$$

At a certain depth, the force holding the geogrid between the blocks will be equal to or greater than the long-term allowable design load of the geogrid. Any layer of geogrid located below this depth may be controlled by tensile overstress and not connection. The depth will be different for each wall depending on the type of soil, the slope of the backfill, and the presence of surcharges, if any.

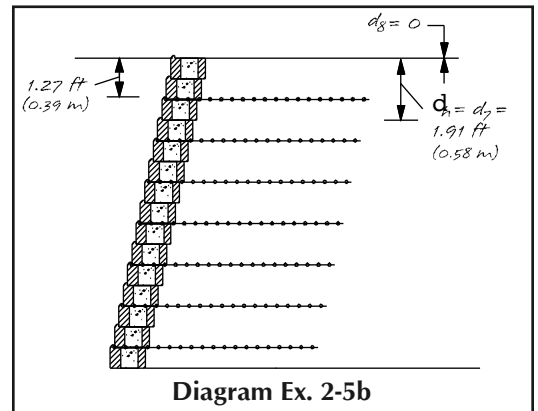

Mechanical Connection

A grouted / mechanical connection may be desirable in special circumstances such as for geogrid layers under high seismic loading or when barriers are attached. The hollow cores of the Allan Block provide for a cell to encapsulate the geogrid placed between block courses. When a grouted connection is specified, a minimum of 3 inches (7.6 cm) of grout above and below the grid layers is required. Factors of safety for this connection are determined by comparing the long-term allowable design strength (LTADS) of the geogrid to the applied load at the face. Please note that designers using a grouted connection should verify with the geogrid manufacturer that their grids are allowed in areas of high alkaline content.

$$SF_{mech} = \frac{LTADS}{(\text{Applied Load}) (RF_{LF})}$$

Example 2-5c: (15 course wall)

Given:

H	= 9.52 ft (2.9 m)	LTADS	= 1322 lb/ft (19,300 N/m)
ϕ	= 30°	L_t	= 6.13 ft (1.87 m)
γ	= 120 lb/ft ³ (1,923 kg/m ³)	Geogrid Courses	= 3, 6, 9, 12
γ_{wall}	= 130 lb/ft ³ (2,061 kg/m ³)	ϕ_{wi}	= 20°

From Example 2-3: $F_{is} = F_{gTopLayer} = P_{avg} (d_h)$ for this example $F_{gTopLayer} = 360 \text{ lb/ft} (5,256 \text{ N/m})$.

Geogrid Pullout from the Soil

Geogrid extends into the backfill soil and the frictional resistance due to the weight of the soil on top of the geogrid provides the restraining force. The relationship can be expressed as follows:

$$F_{gr} = (\text{Unit weight of soil}) \times (\text{Depth to grid}) \\ \times (2) \times (\text{Length of the grid in the passive zone}) \\ \times (\text{Coefficient of friction})$$

The following equation can be used to calculate the maximum potential restraining force:

$$F_{gr} = (2) (d_g) (\gamma_i) (L_e) (C_i) \tan(\phi)$$

where:

d_g = the depth from the top of the infill to the layer of geogrid.

γ_i = the unit weight of the infill soil.

L_e = the length of geogrid embedded in the passive zone of the soil.

C_i = the coefficient of interaction between the soil and the geogrid, a measure of the ability of the soil to hold the geogrid when a force is applied to it. Typical values of C_i are 0.9 for gravelly soil, 0.85 for sand or silty sands, and 0.7 for silts and clays.

$\tan(\phi)$ = the coefficient of friction (shear strength) between adjacent layers of soil.

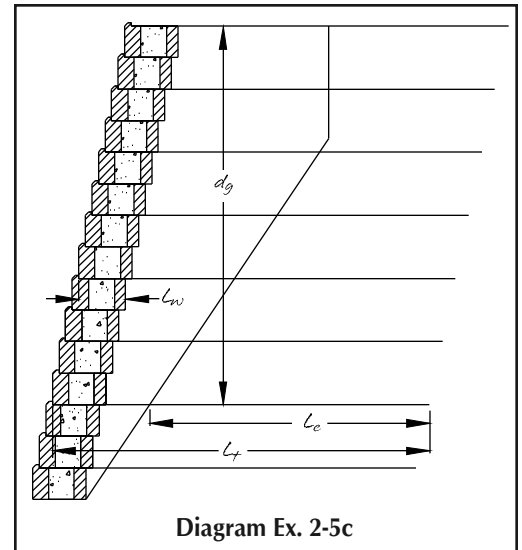

The factor 2 is used because both the top and the bottom of the geogrid interact with the soil.

NOTE: Typically a designer will use a grid length of 60% of wall height, run the Safety Factor for Pullout of Soil calculations, and lengthen the grid if necessary. The following steps can be taken as a check to find the minimum grid lengths required to meet the pullout of soil requirements.

First, the depth to the geogrid, d_g , must be specified. To complete Example 2-5a, let $d_g = 8.89$ ft (2.71 m). Another important assumption is that the geogrid will extend far enough into the passive zone to develop the full allowable design strength of the geogrid. In this case an average strength geogrid will be used, the full long-term allowable load is 1,322 lb/ft (19,300 N/m). A safety factor of 1.5 is applied to this value. The embedment length required to generate that force can be calculated as follows:

$$L_e = \frac{\text{LTADS}}{(F_{gr}) (SF_{\text{pulloutsoil}})}$$

$$F_{gr} = (2) (d_g) (\gamma_i) (L_e) (C_i) \tan(\phi)$$

$$L_e = \frac{\text{LTADS}}{(2) (d_g) (\gamma_i) (L_e) (C_i) \tan(\phi) (SF_{\text{pulloutsoil}})}$$

$$= \sqrt{\frac{(1,322 \text{ lb/ft})}{(2) (8.89 \text{ ft}) (120 \text{ lb/ft}^3) (0.85) \tan(30^\circ) (1.5)}} = 0.92 \text{ ft}$$

$$= \sqrt{\frac{(19,300 \text{ N/m})}{(2) (2.71 \text{ m}) (1,923 \text{ kg/m}^3) (9.81 \text{ m/sec}^2) (0.85) \tan(30^\circ) (1.5)}} = 0.28 \text{ m}$$

The total length of geogrid required per linear foot of wall is:

$$L_t = L_w + L_a + L_e$$

where:

$$L_w = \text{length of geogrid inside the Allan Block unit} = 0.84 \text{ ft} \quad (0.26 \text{ m})$$

$$= \text{Block thickness} - \text{Equivalent lip thickness}$$

$$L_a = \text{length of geogrid in the active zone}$$

$$= (H - d_g) \left[\tan(45^\circ - \phi/2) - \tan(90^\circ - \beta) \right] = 0.23 \text{ ft} \quad (0.07 \text{ m})$$

$$L_e = \text{length of geogrid embedded in the passive zone.}$$

The estimated total length of geogrid required for the wall in Example 2-5 is:

$$L_t = 0.84 \text{ ft} + 0.23 \text{ ft} + 0.84 \text{ ft} = 1.91 \text{ ft}$$

$$= 0.26 \text{ m} + 0.07 \text{ m} + 0.26 \text{ m} = 0.59 \text{ m}$$

Standard practice for design is to use a minimum geogrid length of 60% of the wall height. For this example, $L_t = 6.0 \text{ ft} (1.83 \text{ m})$.

With a total geogrid length of 6.0 ft (1.83 m) the actual embedment length is:

$$L_e = L_t - L_w - L_a$$

$$= 6.0 \text{ ft} - 0.84 \text{ ft} - 0.23 \text{ ft} = 4.93 \text{ ft}$$

$$= 1.83 \text{ m} - 0.26 \text{ m} - 0.07 \text{ m} = 1.5 \text{ m}$$

The maximum potential restraining force on the geogrid for an embedment length of 4.93 feet (1.50 m) is:

$$F_{gr} = (2) (8.89 \text{ ft}) (120 \text{ lb/ft}^3) (4.93 \text{ ft}) (0.85) \tan(30^\circ) = 5,162 \text{ lb/ft}$$

$$= (2) (2.71 \text{ m}) (1,923 \text{ kg/m}^3) (1.50 \text{ m}) (0.85) \tan(30^\circ) (9.81 \text{ m/sec}^2) = 75,266 \text{ N/m}$$

However, the long-term allowable design load (LTADS) of the grid specified is only 1,322 lb/ft (19,300 N/m). The maximum restraining force must be less than or equal to the LTADS. Therefore, F_{gr} is limited to LTADS.

Studies have shown that the line of maximum tension for the soil inside the reinforced soil mass is not well represented by a straight line at an angle of $45^\circ + \phi/2$ to the horizontal. Instead, the line of maximum tension looks more like the one depicted in Figure 2-11. It begins at the bottom rear edge of the wall facing and extends upward at an angle of $45^\circ + \phi/2$ to the horizontal. The failure surface continues upward at that angle until it intersects a vertical line located behind the wall facing a distance equal to 0.3 the height of the wall.

When analyzing the loads on an individual layer of geogrid, the effective depth (d_g) of grid is measured from the grid layer up to the geometric vertical center of the slope above. The geometric vertical center is easily calculated for both continuous and broken back slopes above the wall. If there is no slope above, it is measured to the top of the wall.

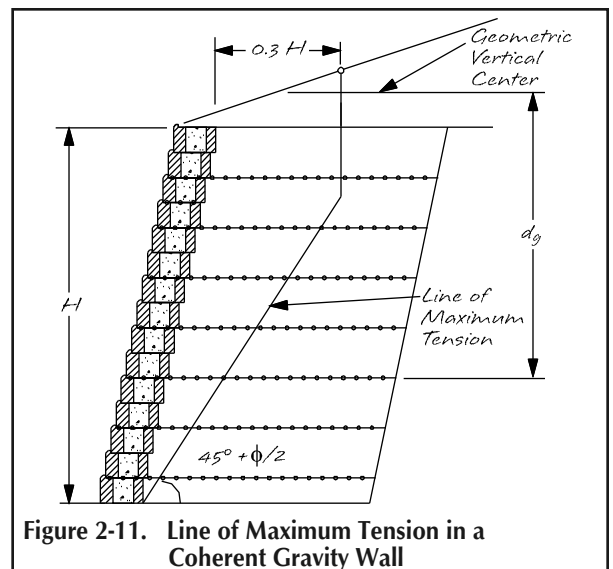

Chapter Three

Surcharges

Introduction

A *surcharge* (q) is an external load applied to the retained soil. Typical surcharges include: sidewalks, driveways, roads, buildings, and other retaining walls. Retaining walls as surcharges will be dealt with in a separate section entitled "Terraced Walls." In this chapter, we will show how to apply the force due to surcharges on simple gravity walls and coherent gravity walls.

The effect a surcharge has on a wall depends on the magnitude of the surcharge and the location of the surcharge relative to the wall. A surcharge located directly behind a wall will have a much greater effect than one located ten or twenty feet behind the wall. Generally, in good soil if the distance from the back of the wall to the surcharge is greater than twice the height of the wall, the effect of the surcharge will be insignificant. *Keep in mind that the back of a coherent gravity wall is located at the end of the geogrid furthest from the wall facing.*



In order to properly determine the effects of a surcharge load, it is necessary to determine how the stress within the soil varies with vertical and horizontal distance from the surcharge. There are several theories about how to calculate the stress at some point within the soil and they range from relatively simple to extremely complex. The one that we have chosen to use is illustrated in Figure 3-1. We assume that the force due to a surcharge load on the retained soil is transmitted downward through the soil at an angle of $45^\circ + \phi/2$ to the horizontal. (ϕ is the friction angle of the soil.) The plane of influence can be approximated by drawing a line up from the bottom rear edge of the wall at an angle of $45^\circ + \phi/2$ until it intersects the top of the backfill. Any surcharge located between the front of the wall and the point of intersection will have a measurable effect on the wall. Surcharges located beyond the point of intersection will have a minimal effect on the wall and will be neglected.

The nature of a surcharge can be defined as a live load or a dead load. Essentially, a live load is that which is transient in its influence on the wall structure and a dead load is that which is taken as a permanent influence on the wall structure. In our calculations for stability, a conservative approach is followed that does not include the presence of the vertical live load weight and vertical forces on the resistance side of the equation.

The location of the live or dead load surcharge, be it the retained soil or the infill soil, affects individual forces on the wall resulting in increased or decreased stability factors of safety. For example, a coherent gravity wall with a live load surcharge on the infill soil will act to decrease FOS overstress and also decrease FOS for sliding and overturning. If the live load surcharge is acting on the retained soil, we see decreases in FOS for sliding and overturning. As for a coherent gravity wall with a dead load surcharge on the infill soils, we see a decrease in FOS for overstress and an increase in FOS for sliding and overturning. If the dead load is on the retained soil, we see an increase in FOS for sliding and overturning.

Another assumption we make in analyzing a surcharge load is that the stress within the soil due to the surcharge is constant with depth. This assumption is fairly accurate for surcharges covering a large area and will result in an error on the conservative side while greatly simplifying the analysis. More exact methods of analysis are available and can be used if desired.

Assumptions:

1. Stress in Soil Due to Surcharge Does Not Vary with Depth.
2. Wall Friction is Neglected in this example.

where:

- X_L = the distance from the front of the top AB Unit to the surcharge.
- L_{PI} = the distance from the front of the top AB Unit to the plane of influence.
- P_q = the pressure due to the surcharge
- q = the surcharge
- H_q = height of wall effected by the surcharge

Table 3-1. Effect of Uniform Surcharge on a Retaining Wall

<p>CASE 1 $X_L = 0$</p>	
<p>$P_q = (q) (K_a)$ Sliding Force: $F_s = (P_q) (H) \cos (\phi_w)$ Overturning Moment: $M_q = (0.5) (H) (F_s)$</p>	
<p>CASE 2 $0 < X_L < L_{PI}$</p>	
<p>$P_q = (q) (K_a)$ Sliding Force: $F_s = (P_q) (H_q) \cos (\phi_w)$ Overturning Moment: $M_q = (0.5) (H_q) (F_s)$</p>	
<p>CASE 3 $X_L \geq L_{PI}$</p>	
<p>$P_q = 0$ Sliding Force: $F_s = 0$ Overturning Moment: $M_q = 0$</p>	

Surcharges on Simple Gravity Walls

Example 3-1:

Figure 3-1 shows the simple gravity wall of Example 2-1 with a uniform dead load surcharge (q) of 120 lb/ft² (6 kPa) behind it. The surcharge is 4 feet wide (1.22 m) and is located right next to the back of the wall. The first step in the analysis is to calculate the pressure on the retaining wall due to the surcharge:

$$\begin{aligned}
 P_q &= (q) (K_a) \\
 &= (120 \text{ lb/ft}^2) (0.2197) &= (6 \text{ kPa}) (0.2197) \\
 &= 26 \text{ lb/ft}^2 &= 1.32 \text{ kPa}
 \end{aligned}$$

Again, because of the effects of friction between the wall and the soil, the pressure due to the surcharge has both a horizontal component and a vertical component. Therefore, the next step in the analysis is to calculate the horizontal and vertical components of the pressure:

$$\begin{aligned}
 P_{qh} &= (P_q) \cos(\phi_w) \\
 &= (26 \text{ lb/ft}^2) \cos(20^\circ) &= (1.32 \text{ kPa}) \cos(20^\circ) \\
 &= 24 \text{ lb/ft}^2 &= 1.24 \text{ kPa} \\
 P_{qv} &= (P_q) \sin(\phi_w) \\
 &= (26 \text{ lb/ft}^2) \sin(20^\circ) &= (1.32 \text{ kPa}) \sin(20^\circ) \\
 &= 9 \text{ lb/ft}^2 &= 0.45 \text{ kPa}
 \end{aligned}$$

Finally, the total surcharge forces on the wall are calculated:

$$\begin{aligned}
 F_{qh} &= (P_{qh}) (H) \\
 &= (24 \text{ lb/ft}^2) (3.81 \text{ ft}) &= (1.24 \text{ kPa}) (1.16 \text{ m}) \\
 &= 91 \text{ lb/ft} &= 1.44 \text{ kN/m} \\
 F_{qv} &= (P_{qv}) (H) \\
 &= (9 \text{ lb/ft}^2) (3.81 \text{ ft}) &= (0.45 \text{ kPa}) (1.16 \text{ m}) \\
 &= 34 \text{ lb/ft} &= 0.52 \text{ kN/m}
 \end{aligned}$$

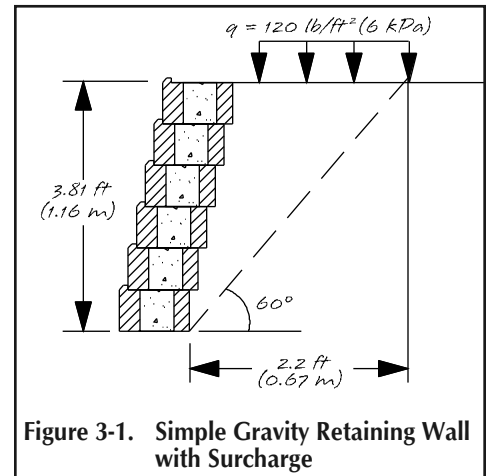

Figure 3-1. Simple Gravity Retaining Wall with Surcharge

Figure 3-2 is a freebody diagram showing the active forces on the wall. Now that the force and pressure distribution due to the surcharge are known, the wall can be analyzed as described in Chapter Two. (The rest of the forces have already been calculated in Example 2-1.) For a simple gravity wall, the horizontal force due to the surcharge is a force that tends to cause both sliding and overturning. Therefore, it must be added to those forces when the safety factors are calculated.

The safety factor against sliding is:

$$\begin{aligned} \text{SFS} &= \frac{F_r + (F_{qv})(C_f)}{F_h + F_{qh}} \\ &= \frac{(315 \text{ lb/ft}) + (34 \text{ lb/ft}) \tan(30^\circ)}{(179 \text{ lb/ft}) + (91 \text{ lb/ft})} = 1.23 \\ &= \frac{(4,613 \text{ N/m}) + (520 \text{ N/m}) \tan(30^\circ)}{(2,620 \text{ N/m}) + (1,440 \text{ N/m})} \end{aligned}$$

(NOTE: F_r and F_h were calculated in Example 2-1).

The safety factor against overturning is:

$$\begin{aligned} \Sigma M_r &= (W_f) [(t/2) + (0.5)(H) \tan(90^\circ - \beta)] \\ &+ (F_v) [(t) + (0.333)(H) \tan(90^\circ - \beta)] \\ &+ (F_{qv}) [(t) + (0.5)(H) \tan(90^\circ - \beta)] \\ &= (480 \text{ lb/ft}) [(0.49 \text{ ft}) + (0.5)(3.81 \text{ ft}) \tan(90^\circ - 78^\circ)] \\ &+ (65 \text{ lb/ft}) [(0.97 \text{ ft}) + (0.333)(3.81 \text{ ft}) \tan(90^\circ - 78^\circ)] \\ &+ (34 \text{ lb/ft}) [(0.97 \text{ ft}) + (0.5)(3.81 \text{ ft}) \tan(90^\circ - 78^\circ)] \\ &= 557 \text{ ft-lb/ft} \\ &= (7,036 \text{ N/m}) [(0.149 \text{ m}) + (0.5)(1.16 \text{ m}) \tan(90^\circ - 78^\circ)] \\ &+ (984 \text{ N/m}) [(0.3 \text{ m}) + (0.333)(1.16 \text{ m}) \tan(90^\circ - 78^\circ)] \\ &+ (520 \text{ N/m}) [(0.3 \text{ m}) + (0.5)(1.16 \text{ m}) \tan(90^\circ - 78^\circ)] \\ &= 2,512 \text{ N-m/m} \end{aligned}$$

$$\begin{aligned} \Sigma M_o &= (F_h)(0.333)(H) + (F_{qh})(0.5)(H) \\ &= (179 \text{ lb/ft})(0.333)(3.81 \text{ ft}) + (91 \text{ lb/ft})(0.5)(3.81 \text{ ft}) \\ &= 400 \text{ ft-lb/ft} \\ &= (2,620 \text{ N/m})(0.333)(1.16 \text{ m}) + (1,440 \text{ N/m})(0.5)(1.16 \text{ m}) \\ &= 1,847 \text{ N-m/m} \end{aligned}$$

$$\begin{aligned} \text{SFO} &= \frac{\Sigma M_r}{\Sigma M_o} = \frac{(557 \text{ ft-lb/ft})}{(400 \text{ ft-lb/ft})} = 1.4 \\ &= \frac{(2,512 \text{ N-m/m})}{(1,847 \text{ N-m/m})} \end{aligned}$$

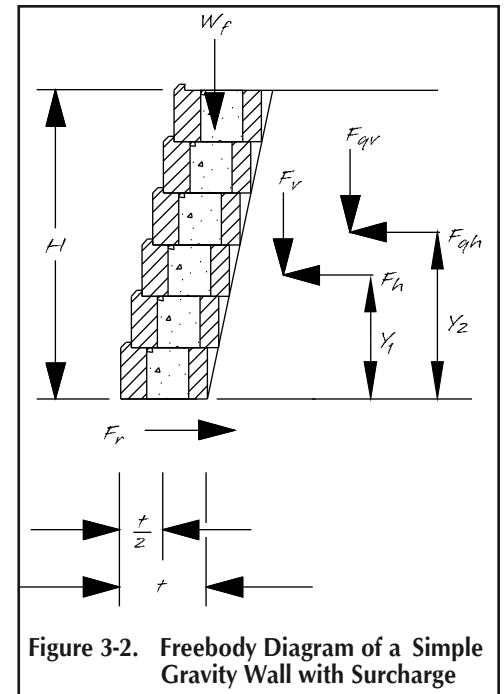

Notice that with the surcharge on the backfill the safety factors are much lower than the recommended minimum values of 1.5 for sliding and 2.0 for overturning. This illustrates that a surcharge can make the difference between a stable wall and an unstable one.

Surcharges on Coherent Gravity Walls

Analyzing the effects of a surcharge on a coherent gravity wall is a two-part problem. First, the effect on the entire reinforced soil mass (external stability) must be analyzed. The surcharge will have an effect on both sliding failure and overturning failure. Second, the effect of the surcharge on the individual layers of geogrid (internal stability) must be analyzed. The surcharge will affect the stress in each layer of geogrid and will influence the spacing of the layers.

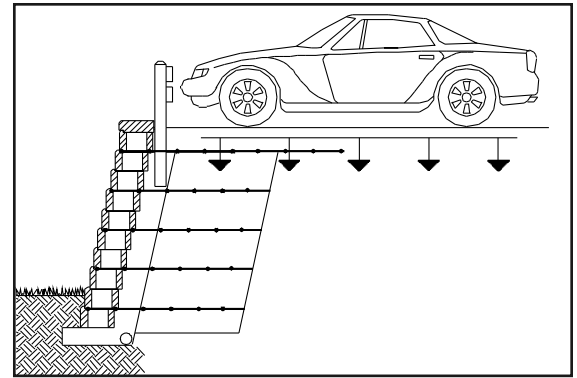

External Stability

The effect of a surcharge on the external stability of a coherent gravity retaining wall is nearly identical to the effect on a simple gravity wall and depends on the location of the surcharge. Recall that the back of a coherent gravity wall is located at the end of the geogrid farthest from the wall facing.

Figure 3-3 shows three possible locations of a dead load surcharge. The surcharge in Location A, because it is above the mass, contributes to the forces resisting both sliding and overturning. Surcharges at location B, because it is located off the mass, contribute to the forces causing sliding and overturning relative to its distance behind the mass. In Location C, the surcharge contributes partly to the forces causing sliding and partly to the forces resisting sliding. In the same manner, it also contributes both to the forces causing overturning and the forces resisting overturning.

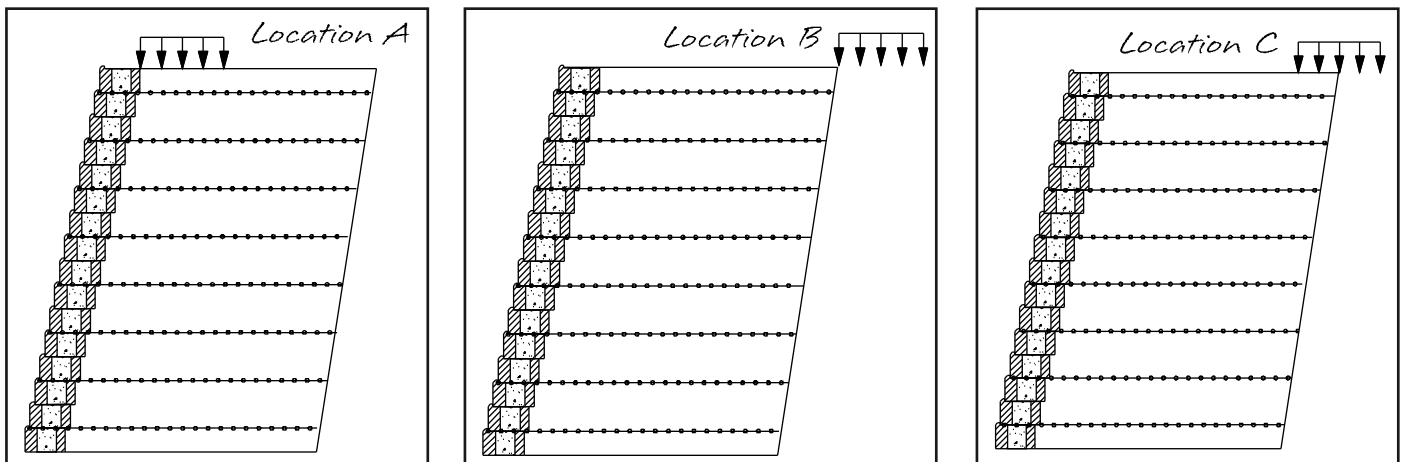

Figure 3-3. Locations of Surcharge on Coherent Gravity Walls

Example 3-3:

Consider the coherent gravity wall analyzed in Example 2-3, but with a three-foot-wide dead load surcharge of 120 lb/ft² (6 kPa). Analyze the external stability of the wall with the surcharge in the three locations shown in Figure 3-3.

Location A:

The surcharge can be resolved into an equivalent vertical force, Q , of 360 lb/ft (5,256 N/m) that is located 2.5 ft (0.762 m) from the front face of the wall and acts at the center of the uniform surcharge. This force will be added to the forces resisting sliding when calculating F_r .

To determine the horizontal and vertical components of force due to the surcharge first calculate the active force. However because the entire surcharge is above the mass, all active forces are equal to zero. Only the weight of the deadload surcharge is applied to the sliding and overturning calculations.

$$\begin{aligned}
 F_q &= (Q) (K_a) (H_Q) \\
 &= (120 \text{ lb/ft}^2) (0.2561) (0 \text{ ft}) = 0 \text{ lbs/ft due to Location A} \\
 &= (5,748 \text{ Pa}) (0.2561) (0 \text{ m}) = 0 \text{ N/m due to Location A}
 \end{aligned}$$

The horizontal and vertical components of the force on the reinforced soil mass due to the surcharge are:

$$F_{qh} = (F_q) \cos (\phi_{wr})$$

$$= (0 \text{ lb/ft}) \cos (18^\circ) = 0 \text{ lb/ft} \quad = (0 \text{ N/m}) \cos (18^\circ) = 0 \text{ N/m}$$

$$F_{qv} = (F_q) \sin (\phi_{wr})$$

$$= (0 \text{ lb/ft}) \sin (18^\circ) = 0 \text{ lb/ft} \quad = (0 \text{ N/m}) \sin (18^\circ) = 0 \text{ N/m}$$

Notice that the pressure coefficient for the onsite soil is used. This is because for sliding we take the least soil friction angle to be conservative.

Sliding Resistance Equation

$$F_r = (W_w + F_v + F_{qv} + Q) (C_f)$$

$$= [(7,340 \text{ lb/ft}) + (430 \text{ lb/ft}) + (0 \text{ lb/ft}) + (360 \text{ lb/ft})] \tan (30^\circ) = 4,694 \text{ lb/ft}$$

$$= [(107,237 \text{ N/m}) + (6,278 \text{ N/m}) + (0 \text{ N/m}) + (5,256 \text{ N/m})] \tan (30^\circ) = 68,570 \text{ N/m}$$

Sliding Forces

$$F_s = F_h + F_{qh}$$

$$= 1,325 \text{ lb/ft} + 0 \text{ lb/ft} = 1,325 \text{ lb/ft}$$

$$= 19,321 \text{ N/m} + 0 \text{ N/m} = 19,321 \text{ N/m}$$

The new safety factor against sliding is:

$$SFS = \frac{F_r}{F_s} = \frac{(4,694 \text{ lb/ft})}{(1,325 \text{ lb/ft})} = 3.54$$

$$= \frac{(68,570 \text{ N/m})}{(19,321 \text{ N/m})} = 3.54$$

Q can also be added to the moments of the forces resisting overturning:

where:

X_1 = distance to the center line of the reinforced mass

X_2 = distance to the back of the reinforced mass

X_3 = distance to the center line of the surcharge

$$\Sigma M_r = (W_w) [(X_1) + (0.5) (H) \tan (90^\circ - \beta)]$$

$$+ (F_v) [(X_2) + (0.333) (H) \tan (90^\circ - \beta)]$$

$$+ (Q) [(X_3) + (H) \tan (90^\circ - \beta)]$$

$$+ F_{qv} [(X_2) + (0.5) (H) \tan (90^\circ - \beta)]$$

$$= (7,340 \text{ lb/ft}) [(3.0 \text{ ft}) + (0.5) (9.52 \text{ ft}) \tan (90^\circ - 78^\circ)]$$

$$+ (430 \text{ lb/ft}) [(6.13 \text{ ft}) + (0.333) (9.52 \text{ ft}) \tan (90^\circ - 78^\circ)]$$

$$+ (360 \text{ lb/ft}) [(2.5 \text{ ft}) + (9.52 \text{ ft}) \tan (90^\circ - 78^\circ)]$$

$$+ (0 \text{ lb/ft}) [(6.13 \text{ ft}) + (0.5) (9.52 \text{ ft}) \tan (90^\circ - 78^\circ)]$$

$$= 34,000 \text{ ft-lb/ft}$$

$$= (107,237 \text{ N/m}) [(0.91 \text{ m}) + (0.5) (2.9 \text{ m}) \tan (90^\circ - 78^\circ)]$$

$$+ (6,278 \text{ N/m}) [(1.87 \text{ m}) + (0.333) (2.9 \text{ m}) \tan (90^\circ - 78^\circ)]$$

$$+ (5,256 \text{ N/m}) [(0.762 \text{ m}) + (2.9 \text{ m}) \tan (90^\circ - 78^\circ)]$$

$$+ (0 \text{ N/m}) [(1.87 \text{ m}) + (0.5) (2.9 \text{ m}) \tan (90^\circ - 78^\circ)]$$

$$= 150,912 \text{ N-m/m}$$

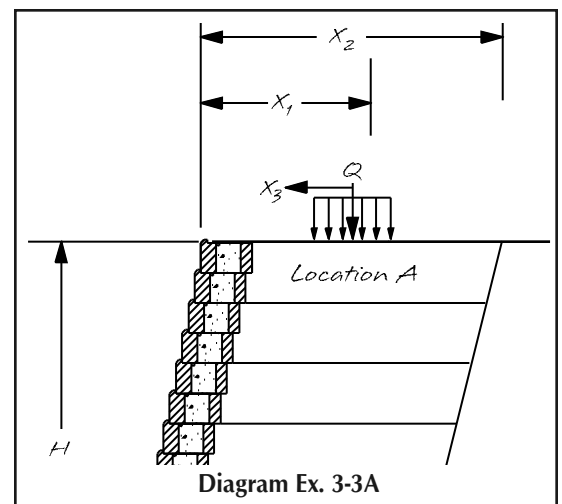

$$\begin{aligned}\Sigma M_o &= (F_h) (0.333) (9.52 \text{ ft}) + (F_{qh}) (0.5) (9.52 \text{ ft}) \\ &= (1,325 \text{ lb/ft}) (0.333) (9.52 \text{ ft}) + (0 \text{ lb/ft}) (0.5) (9.52 \text{ ft}) \\ &= 4,200 \text{ ft-lb/ft}\end{aligned}$$

$$\begin{aligned}&= (19,321 \text{ N/m}) (0.333) (2.9 \text{ m}) + (0 \text{ N/m}) (0.5) (2.9 \text{ m}) \\ &= 18,658 \text{ N-m/m}\end{aligned}$$

The new safety factor against overturning is:

$$SFO = \frac{\Sigma M_r}{\Sigma M_o} = \frac{(34,000 \text{ ft-lb/ft})}{(4,200 \text{ ft-lb/ft})} = 8.1 = \frac{(150,912 \text{ N-m/m})}{(18,658 \text{ N-m/m})} = 8.1$$

Thus, the effect of a surcharge in Location A is to make the wall slightly more stable with respect to sliding and overturning. However, such a surcharge can have a detrimental effect on the internal stability of the wall. Also, the added force due to the surcharge must be taken into account when calculating the bearing pressure on the underlying soil.

Location B:

A surcharge in this location has the same effect on the external stability of a coherent gravity wall as on a simple gravity wall. In this case, the entire surcharge results in a horizontal force behind the back of the reinforced soil mass.

Therefore the disipated magnitude of the force is:

$$\begin{aligned}F_q &= (q) (H-H_Q) (K_a) \\ &= (120 \text{ lb/ft}^2) (9.52 \text{ ft} - 3.1 \text{ ft}) (0.2561) = 1.97 \text{ lb/ft} = (5,748 \text{ Pa}) (2.9 \text{ m} - 0.94 \text{ m}) (0.2561) = 2,885 \text{ N/m}\end{aligned}$$

$$\begin{aligned}F_{qh} &= (F_q) \cos (\phi_{wr}) \\ &= (197 \text{ lb/ft}) \cos (18^\circ) = 187.3 \text{ lb/ft} = (2,885 \text{ N/m}) \cos (18^\circ) = 2,743 \text{ N/m}\end{aligned}$$

$$\begin{aligned}F_{qv} &= (F_q) \sin (\phi_{wr}) \\ &= (197 \text{ lb/ft}) \sin (18^\circ) = 60.9 \text{ lb/ft} = (2,885 \text{ N/m}) \sin (18^\circ) = 892 \text{ N/m}\end{aligned}$$

For Location B, the safety factors against sliding and overturning are:

$$\begin{aligned}SFS &= \frac{F_r + (F_{qv}) (C_f)}{F_h + F_{qh}} \\ &= \frac{4,746 \text{ lb/ft} + 60.9 \text{ lb/ft} (\tan 27^\circ)}{1,325 \text{ lb/ft} + 187.3 \text{ lb/ft}} = 3.2 \\ &= \frac{69,332 \text{ N/m} + 892 \text{ N/m} (\tan 27^\circ)}{19,321 \text{ N/m} + 2,743 \text{ N/m}} = 3.2\end{aligned}$$

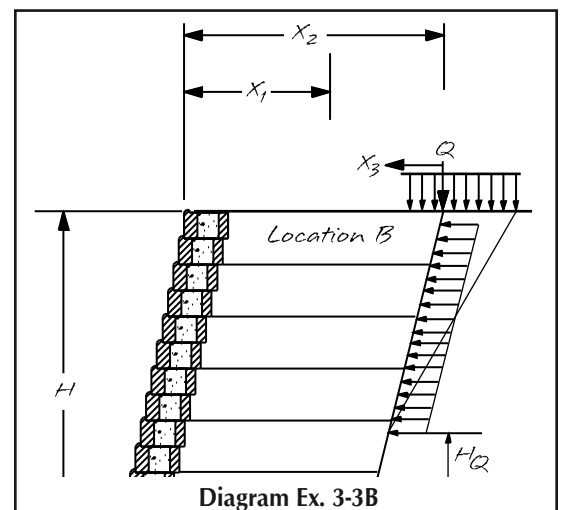

$$\begin{aligned}
 \text{SFO} &= \frac{\sum M_r + (F_{qv}) [(X_2) + (0.5) (H + H_Q) \tan (90^\circ - \beta)]}{\sum M_o + (F_{qh}) (0.5) (H + H_Q)} \\
 &= \frac{34,650 \text{ ft-lb/ft} + 60.9 \text{ lb/ft} [6.13 \text{ ft} + (0.5) (9.52 \text{ ft} + 3.1 \text{ ft}) \tan (90^\circ - 78^\circ)]}{5,522 \text{ ft-lb/ft} + (187.3 \text{ lb/ft}) (0.5) (9.52 \text{ ft} + 3.1 \text{ ft})} = 5.3 \\
 &= \frac{153,785 \text{ N-m/m} + 892 \text{ N/m} [(1.87 \text{ m}) + (0.5) (2.9 \text{ m} + 0.94 \text{ m}) \tan (90^\circ - 78^\circ)]}{24,545 \text{ N-m/m} + (2,743 \text{ N/m}) (0.5) (2.9 \text{ m} + 0.94 \text{ m})} = 5.3
 \end{aligned}$$

Location C:

With the surcharge at Location C, half of the surcharge is over the reinforced soil zone and half is not. Therefore, the effects on the coherent gravity wall are a combination of the effects of a surcharge at Location A and a surcharge at Location B. The part of the surcharge over the geogrid will contribute to the stability of the wall with respect to its weight. The horizontal and vertical components of the force on the reinforced soil mass due to the surcharge are:

$$\begin{aligned}
 F_q &= (q) (H - H_Q) (K_a) \\
 &= (120 \text{ lb/ft}^2) (9.52 \text{ ft} - 6.3 \text{ ft}) (0.2561) = 99 \text{ lb/ft} \quad = (5,742 \text{ Pa}) (2.9 \text{ m} - 1.92 \text{ m}) (0.2561) = 1,441 \text{ N/m}
 \end{aligned}$$

$$\begin{aligned}
 F_{qh} &= (F_q) \cos (\phi_{wr}) \\
 &= (99 \text{ lb/ft}) \cos (18^\circ) = 94 \text{ lb/ft} \quad = (1,441 \text{ N/m}) \cos (18^\circ) = 1,370 \text{ N/m}
 \end{aligned}$$

$$\begin{aligned}
 F_{qv} &= (F_q) \sin (\phi_{wr}) \\
 &= (99 \text{ lb/ft}) \sin (18^\circ) = 30.6 \text{ lb/ft} \quad = (1,441 \text{ N/m}) \sin (18^\circ) = 445 \text{ N/m}
 \end{aligned}$$

The force resisting sliding is:

$$\begin{aligned}
 F_r &= [W_w + F_v + 0.5 (Q) + F_{qv}] (C_f) \\
 &= [7,340 \text{ lb/ft} + 430 \text{ lb/ft} + 0.5 (360 \text{ lb/ft}) + 30.6 \text{ lb/ft}] \tan 30^\circ = 4,608 \text{ lb/ft} \\
 &= [107,237 \text{ N/m} + 6,278 \text{ N/m} + 0.5 (5,256 \text{ N/m}) + 445 \text{ N/m}] \tan 30^\circ = 67,312 \text{ N/m}
 \end{aligned}$$

The force causing sliding is:

$$\begin{aligned}
 F_s &= F_h + F_{qh} \\
 &= 1,325 \text{ lb/ft} + 94 \text{ lb/ft} = 1,419 \text{ lb/ft} \quad = 19,321 \text{ N/m} + 1,441 \text{ N/m} = 20,762 \text{ N/m}
 \end{aligned}$$

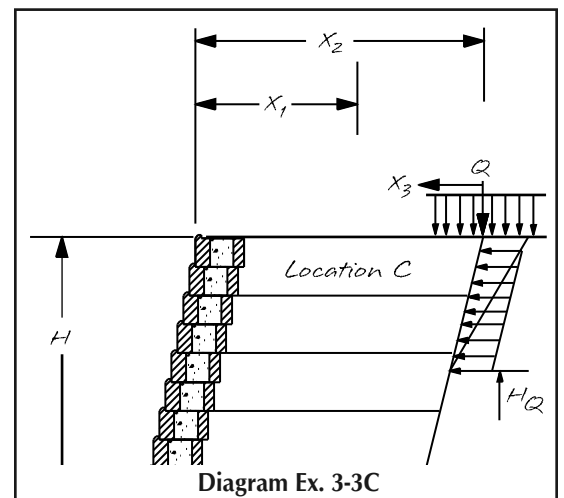

The safety factor against sliding is:

$$\begin{aligned} \text{SFS} &= \frac{(4,608 \text{ lb/ft})}{(1,419 \text{ lb/ft})} = 3.3 \\ &= \frac{(67,312 \text{ N/m})}{(20,762 \text{ N/m})} = 3.3 \end{aligned}$$

The sum of the moments resisting overturning is:

$$\begin{aligned} \Sigma M_r &= (W_w) [(X_1) + (0.5) (H) \tan (90^\circ - \beta)] \\ &+ (F_v) [(X_2) + (0.333) (H) \tan (90^\circ - \beta)] \\ &+ (F_{qv}) [(X_2) + (0.5) (H + H_Q) \tan (90^\circ - \beta)] \\ &+ (0.5) (Q) [(X_3) + (H) \tan (90^\circ - \beta)] \\ &= (7,340 \text{ lb/ft}) [(3.0 \text{ ft}) + (0.5) (9.52 \text{ ft}) \tan (90^\circ - 78^\circ)] \\ &+ (430 \text{ lb/ft}) [(6.13 \text{ ft}) + (0.333) (9.52 \text{ ft}) \tan (90^\circ - 78^\circ)] \\ &+ (30.6 \text{ lb/ft}) [(6.13 \text{ ft}) + (0.5) (9.52 \text{ ft} + 6.3 \text{ ft}) \tan (90^\circ - 78^\circ)] \\ &+ (0.5) (360 \text{ lb/ft}) [(5.38 \text{ ft}) + (9.52 \text{ ft}) \tan (90^\circ - 78^\circ)] \\ &= 33,943 \text{ ft-lb/ft} \\ &= (107,237 \text{ N-m}) [(0.91 \text{ m}) + (0.5) (2.9 \text{ m}) \tan (90^\circ - 78^\circ)] \\ &+ (6,278 \text{ N-m}) [(1.87 \text{ m}) + (0.333) (2.9 \text{ m}) \tan (90^\circ - 78^\circ)] \\ &+ (445 \text{ N-m}) [(1.87 \text{ m}) + (0.5) (2.9 \text{ m} + 1.92 \text{ m}) \tan (90^\circ - 78^\circ)] \\ &+ (0.5) (5,256 \text{ N-m}) [(1.64 \text{ m}) + (2.9 \text{ m}) \tan (90^\circ - 78^\circ)] \\ &= 150,645 \text{ N-m/m} \end{aligned}$$

The sum of the moments causing overturning is:

$$\begin{aligned} \Sigma M_o &= (F_h) (0.333) (H) + (F_{qh}) (0.5) (H - H_Q) \\ &= (1,325 \text{ lb/ft}) (0.333) (9.52 \text{ ft}) + (94 \text{ lb/ft}) (0.5) (9.52 \text{ ft} + 6.3 \text{ ft}) \\ &= 4,944 \text{ ft-lb/ft} \\ &= (19,321 \text{ N-m}) (0.333) (2.9 \text{ m}) + (1,370 \text{ N-m}) (0.5) (2.9 \text{ m} + 1.92 \text{ m}) \\ &= 21,948 \text{ N-m/m} \end{aligned}$$

The safety factor against overturning is:

$$\text{SFO} = \frac{(33,943 \text{ ft-lb/ft})}{(4,944 \text{ ft-lb/ft})} = 6.86 = \frac{(150,645 \text{ N-m/m})}{(21,948 \text{ N-m/m})} = 6.86$$

If the surcharge was considered as a live load (ie: traffic), only the component of the surcharge force driving failure would be included.



Internal Stability

In addition to its effects on sliding and overturning failure, a surcharge can also have an impact on the spacing of the geogrid layers. It does so by putting an additional load on some or all of the layers of geogrid.

The first step in analyzing the effects of a surcharge on internal stability is to determine the horizontal soil stress within the reinforced soil zone. Once again, we will use the wall of Example 2-3 with a surcharge of 120 lb/sq ft (5,747 Pa), located as shown in Figure 3-4. The surcharge is 2 ft (0.61 m) wide.

Notice the diagonal lines connected to the beginning and end of the surcharge pressure diagram. These lines are drawn at an angle of $45^\circ + \phi/2$ to the horizontal and mark the limits of the zone of influence of the surcharge within the soil. The horizontal stress due to the surcharge will act only on the portion of the retaining wall located in the area labeled "ZONE OF INFLUENCE."

The magnitude of the horizontal surcharge stress is:

$$\begin{aligned}
 P_{qh} &= (q) (K_{ai}) \cos (\phi_{wi}) \\
 &= (120 \text{ lb/ft}^2) (0.2197) \cos (20^\circ) \\
 &= 25 \text{ lb/ft}^2 \\
 &= (5,747 \text{ Pa}) (0.2197) \cos (20^\circ) \\
 &= 1,186 \text{ Pa}
 \end{aligned}$$

Figure 3-5 shows the wall facing with the two pressure distributions that affect it - one due to the soil weight and one due to the surcharge. The rectangular pressure distribution represents the effect of the surcharge on the wall facing.

Example 3-4:

Given the wall shown in Figure 3-4 and using the data of Example 2-3, determine the force acting on the first layer of grid.

$$F_g = (P_{avg}) (d_h)$$

Where:

$$P_{avg} = (0.5) (\gamma_i) (K_{ai}) \cos (\phi_{wi}) (d_1 + d_2)$$

$$d_h = (d_1 - d_2)$$

Since the pressure from the surcharge remains constant, add P_{qh} to P_{avg} . So:

$$F_g = [(0.5) (\gamma_i) (K_{ai}) \cos (\phi_{wi}) (d_1 + d_2) + (q) (K_{ai}) \cos (\phi_{wi})] (d_1 - d_2)$$

For the first layer of grid:

$$d_1 = 9.53 \text{ ft } (2.93 \text{ m})$$

$$d_2 = 8.26 \text{ ft } (2.5 \text{ m})$$

$$F_{g1} = [(0.5) (125 \text{ lb/ft}^3) (0.2197) \cos (20^\circ) (9.53 \text{ ft} + 8.26 \text{ ft}) + (120 \text{ lb/ft}^2) (0.2197) \cos (20^\circ)] (9.53 \text{ ft} - 8.26 \text{ ft})$$

$$= 291.5 \text{ lb/ft}$$

$$\begin{aligned}
 &= [(0.5) (2,002 \text{ kg/m}^3) (0.2197) \cos (20^\circ) (2.9 \text{ m} + 2.5 \text{ m}) + (5,800 \text{ N/m}^2) (0.2197) \cos (20^\circ)] (2.9 \text{ m} - 2.5 \text{ m}) \\
 &= 4.256 \text{ kN/m}
 \end{aligned}$$

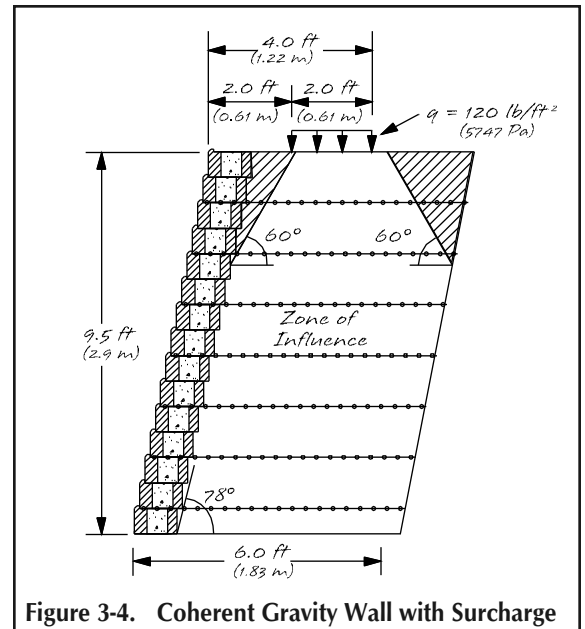

Figure 3-4. Coherent Gravity Wall with Surcharge

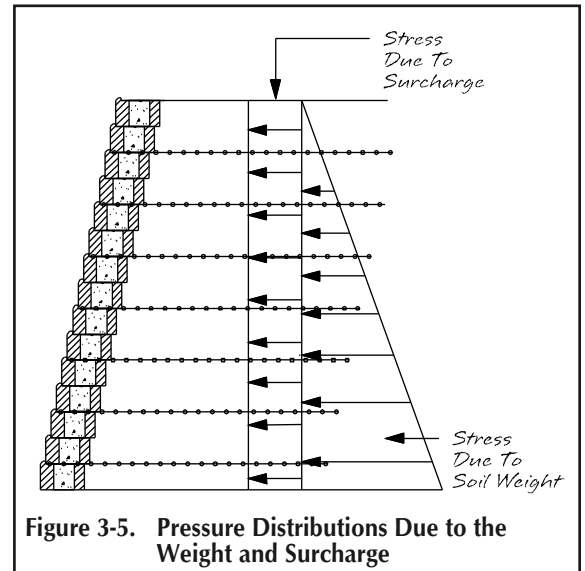

Figure 3-5. Pressure Distributions Due to the Weight and Surcharge



CHAPTER FOUR

Sloped Backfill

Introduction

Sometimes it is not feasible or desirable to build a retaining wall that is tall enough to allow for a flat backfill. In that case, the backfill must be sloped. Sloped backfill is one of the most significant factors contributing to the active force on the wall. The slope of the backfill must be taken into account when designing a geogrid-reinforced retaining wall. Also, it should be noted that the slope of the backfill cannot exceed the friction angle of the soil. (This is not true if the cohesion of the soil is taken into account. However, the design procedures in this manual are based on the assumption that cohesion is not used in the methods outlined.)

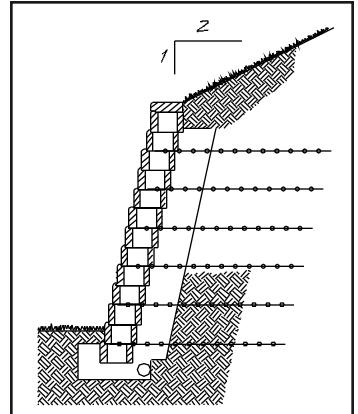

Simple Gravity Walls With Sloped Backfill

As discussed in Chapter One, Coulomb's equation for the active force on the wall includes a term that changes the magnitude of the pressure coefficient as the slope of the backfill changes. The active pressure coefficient of Coulomb's equation is given by:

where: i = the slope of the backfill.

$$K_a = \left[\frac{\csc(\beta) \sin(\beta - \phi)}{\sqrt{\sin(\beta + \phi_w)} + \sqrt{\frac{\sin(\phi + \phi_w) \sin(\phi - i)}{\sin(\beta - i)}}} \right]^2$$

Let's look at the wall in Example 2-1 and see what effect changing the backfill slope has on the active force.

Example 4-1:

Given:

$$\begin{aligned} \phi_w &= 20^\circ & \beta &= 78^\circ \\ \phi &= 30^\circ & H &= 3.81 \text{ ft (1.16 m)} \\ \gamma &= 120 \text{ lb/ft}^3 \text{ (1,923 kg/m}^3\text{)} \\ \gamma_{\text{wall}} &= 130 \text{ lb/ft}^3 \text{ (2,061 kg/m}^3\text{)} \end{aligned}$$

The table below shows the effect increasing the backfill slope has on the active pressure coefficient and the active force.

i (degrees)	K_a	F_a 1 lb/ft (1 N/m)
0	0.2197	191 (2,788)
18	0.2847	248 (3,613)
26	0.3662	319 (4,648)

Changing the slope of the backfill from 0° to 26° increased the active force by 67%. The wall in Example 2-1 would not be stable if the back-fill had a slope of 26°. For simple gravity walls, the effect of the sloping backfill is automatically taken into account by using Coulomb's equation to calculate the active force.

Coherent Gravity Walls With Sloped Backfill

One effect of a sloped backfill on a coherent gravity wall is to increase the weight of the wall and consequently, the resistance to sliding. The increased weight is due to the backfill soil that is located above the wall facing and over the reinforced soil mass. In Figure 4-1, the area designated W_i contains the soil that contributes the extra weight. The total weight of the wall can be calculated by adding the weight of the rectangular section, W_r to the weight of the triangular section, W_i :

$$\begin{aligned} W_r &= (130 \text{ lb/ft}^3) (9.52 \text{ ft}) (0.97 \text{ ft}) \\ &+ (125 \text{ lb/ft}^3) (9.52 \text{ ft}) (6.0 \text{ ft} - 0.97 \text{ ft}) \\ &= 7,186 \text{ lb/ft} \end{aligned}$$

$$\begin{aligned} &= (2,061 \text{ kg/m}^3) (2.9 \text{ m}) (0.3 \text{ m}) \\ &+ (2,002 \text{ kg/m}^3) (2.9 \text{ m}) (1.83 \text{ m} - 0.3 \text{ m}) \\ &= 104,731 \text{ N/m} \end{aligned}$$

$$\begin{aligned} W_i &= (0.5) (6.0 \text{ ft}) [(6.0 \text{ ft}) \tan (18^\circ)] (125 \text{ lb/ft}^3) \\ &= 731 \text{ lb/ft} \end{aligned}$$

$$\begin{aligned} &= (0.5) (1.83 \text{ m}) [(1.83 \text{ m}) \tan (18^\circ)] (2,002 \text{ kg/m}^3) \\ &= 10,685 \text{ N/m} \end{aligned}$$

$$\begin{aligned} W_{ww} &= (W_r) + (W_i) \\ &= (7,186 \text{ lb/ft}) + (731 \text{ lb/ft}) = 7,917 \text{ lb/ft} \end{aligned}$$

$$= (104,731 \text{ N/m}) + (10,685 \text{ N/m}) = 115,416 \text{ N/m}$$

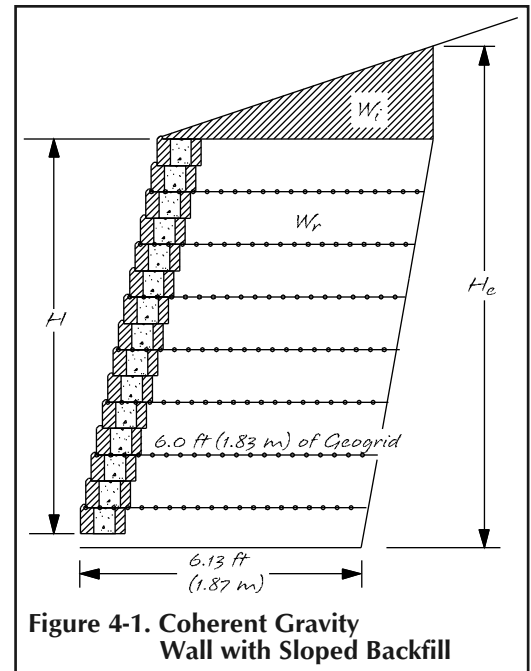

External Stability

The external stability of the wall can be calculated as it was in Example 2-3, with three differences. First, the weight of the wall is greater, as shown above. Second, the height of the retaining wall is taken to be the height at the back of the reinforced soil mass, H_e . Third, the active force on the retained soil mass is greater because of the sloping backfill. The increase in the active force is automatically accounted for by using Coulomb's equation to calculate the active force. Calculate the safety factors for sliding and overturning of the wall in Figure 4-1. Compare these values to the safety factors in Example 2-3.

Example 4-3:

Given:

ϕ_i	=	30°	i	=	18°	H	=	9.52 ft	(2.9 m)
ϕ_{wi}	=	20°	β	=	78°	γ_r	=	120 lb/ft^3	$(1,923 \text{ kg/m}^3)$
ϕ_r	=	27°	K_{ar}	=	0.3440	γ_i	=	125 lb/ft^3	$(2,002 \text{ kg/m}^3)$
ϕ_{wr}	=	18°	K_{ai}	=	0.2847				

The first step is to calculate the effective height, H_e at the rear of the coherent gravity wall:

$$\begin{aligned} H_e &= (H) + (L_g) \tan (i) \\ &= (9.52 \text{ ft}) + (6.0 \text{ ft}) \tan (18^\circ) = 11.47 \text{ ft} \end{aligned}$$

$$= (2.9 \text{ m}) + (1.83 \text{ m}) \tan (18^\circ) = 3.49 \text{ m}$$

Next, the active force on the coherent gravity wall is calculated:

$$\begin{aligned} F_a &= (0.5) (\gamma_r) (K_{ar}) (H_e)^2 \\ &= (0.5) (120 \text{ lb/ft}^3) (0.344) (11.47 \text{ ft})^2 = 2,636 \text{ lb/ft} \end{aligned}$$

$$= (0.5) (1,923 \text{ kg/m}^3) (0.3440) (3.49 \text{ m})^2 = 38,372 \text{ N/m}$$

The horizontal component of the active force is:

$$\begin{aligned} F_h &= (F_a) \cos (\phi_{wr}) \\ &= (2,636 \text{ lb/ft}) \cos (18^\circ) = 2,507 \text{ lb/ft} \end{aligned}$$

$$= (38,372 \text{ N/m}) \cos (18^\circ) = 36,494 \text{ N/m}$$

The vertical component of the active force is:

$$F_v = (F_a) \sin(\phi_{wr}) = (2,636 \text{ lb/ft}) \sin(18^\circ) = 815 \text{ lb/ft} = (38,372 \text{ N/m}) \sin(18^\circ) = 11,858 \text{ N/m}$$

The force resisting sliding is:

$$F_r = (W_w + F_v) (C_f) = (7,917 \text{ lb/ft} + 815 \text{ lb/ft}) \tan(30^\circ) = 5,041 \text{ lb/ft} = (115,416 \text{ N/m} + 11,858 \text{ N/m}) \tan(30^\circ) = 73,482 \text{ N/m}$$

The safety factor against sliding is:

$$SFS = \frac{F_r}{F_h} = \frac{(5,041 \text{ lb/ft})}{(2,507 \text{ lb/ft})} = 2.01 = \frac{(73,482 \text{ N/m})}{(36,494 \text{ N/m})} = 2.01$$

The moment resisting overturning is:

where:

- X_1 = distance to the center line AB block
- X_2 = distance to the center line of the reinforced mass
- X_3 = distance to the centroid of the backslope
- X_4 = distance to the back of the reinforced mass

$$\begin{aligned} \Sigma M_r &= (W_f) [(X_1) + (0.5) (H) \tan(90^\circ - \beta)] + (W_r) [(X_2) + (0.5) (H) \tan(90^\circ - \beta)] \\ &+ (W_i) [(X_3) + (H) \tan(90^\circ - \beta)] + (F_v) [(X_4) + (0.333) (H_e) \tan(90^\circ - \beta)] \\ &= (1,142 \text{ lb/ft}) [(0.49 \text{ ft}) + (0.5) (9.52 \text{ ft}) \tan(90^\circ - 78^\circ)] \\ &+ (7,186 \text{ lb/ft}) [(3.47 \text{ ft}) + (0.5) (9.52 \text{ ft}) \tan(90^\circ - 78^\circ)] \\ &+ (731 \text{ lb/ft}) [(4.08 \text{ ft}) + (9.52 \text{ ft}) \tan(90^\circ - 78^\circ)] \\ &+ (815 \text{ lb/ft}) [(6.13 \text{ ft}) + (0.333) (11.47 \text{ ft}) \tan(90^\circ - 78^\circ)] \\ &= 43,876 \text{ ft-lb/ft} \\ &= (16,673 \text{ N/m}) [(0.149 \text{ m}) + (0.5) (2.9 \text{ m}) \tan(90^\circ - 78^\circ)] \\ &+ (104,731 \text{ N/m}) [(1.05 \text{ m}) + (0.5) (2.9 \text{ m}) \tan(90^\circ - 78^\circ)] \\ &+ (10,685 \text{ N/m}) [(1.21 \text{ m}) + (2.9 \text{ m}) \tan(90^\circ - 78^\circ)] \\ &+ (11,858 \text{ N/m}) [(1.82 \text{ m}) + (0.333) (3.49 \text{ m}) \tan(90^\circ - 78^\circ)] \\ &= 193,895 \text{ N-m/m} \end{aligned}$$

The moment causing overturning is:

$$M_o = (F_h) (0.333) (H_e) = (2,507 \text{ lb/ft}) (0.333) (11.47 \text{ ft}) = 9,576 \text{ ft-lb/ft} = (36,494 \text{ N/m}) (0.333) (3.49 \text{ m}) = 42,412 \text{ N-m/m}$$

The safety factor against overturning is:

$$SFO = \frac{\Sigma M_r}{\Sigma M_o} = \frac{(43,876 \text{ ft-lb/ft})}{(9,576 \text{ ft-lb/ft})} = 4.58 = \frac{\Sigma M_r}{\Sigma M_o} = \frac{(193,895 \text{ N-m/m})}{(42,412 \text{ N-m/m})} = 4.58$$

As calculated in Example 2-3, the same wall with a flat backfill had a safety factor against sliding of 3.4 and a safety factor against overturning of 7.8. Sloping the backfill cut the safety factors by 41% for sliding and 42% for overturning.

Internal Stability

Let's examine the effect of sloping backfill on the bottom layer of geogrid in the wall shown in Figure 4-3. The load on a layer of geogrid is given by:

$$F_g = (P_{avg}) (d_h)$$

Suppose the wall in Figure 4-3 had a flat backfill, the load on the bottom layer of geogrid would be:

$$\begin{aligned} F_1 &= (P_{avg}) (d_h) \\ &= (0.5) (P_1 + P_2) (d_1 - d_2) \\ &= (0.5) [(\gamma_i) (K_{ai}) (d_1) \cos(\phi_{wi}) + (\gamma_i) (K_{ai}) (d_2) \cos(\phi_{wi})] (d_1 - d_2) \\ &= (0.5) [(125 \text{ lb/ft}^3) (0.2197) (9.52 \text{ ft}) \cos(20^\circ) \\ &\quad + (125 \text{ lb/ft}^3) (0.2197) (8.25 \text{ ft}) \cos(20^\circ)] (9.52 \text{ ft} - 8.25 \text{ ft}) = 291 \text{ lb/ft} \end{aligned}$$

$$\begin{aligned} &= (0.5) [(2,002 \text{ kg/m}^3) (0.2197) (2.9 \text{ m}) \cos(20^\circ) \\ &\quad + (2,002 \text{ kg/m}^3) (0.2197) (2.51 \text{ m}) \cos(20^\circ)] (2.9 \text{ m} - 2.51 \text{ m}) (9.81 \text{ m/sec}^2) = 4,237 \text{ N/m} \end{aligned}$$

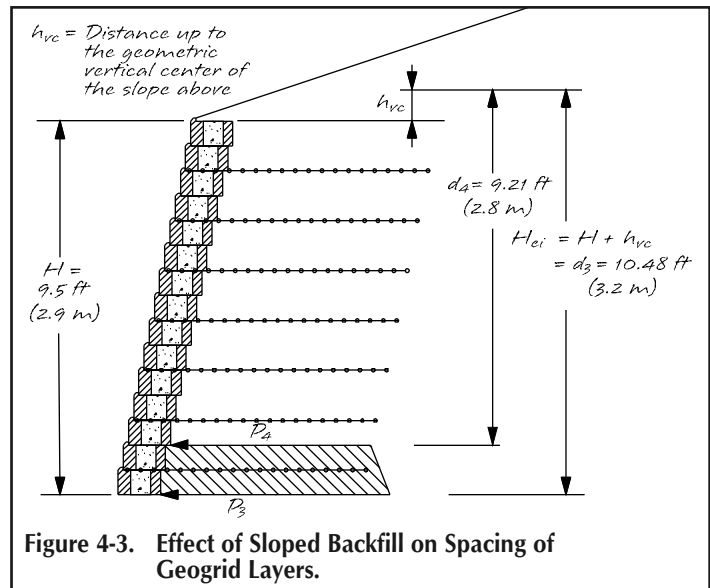
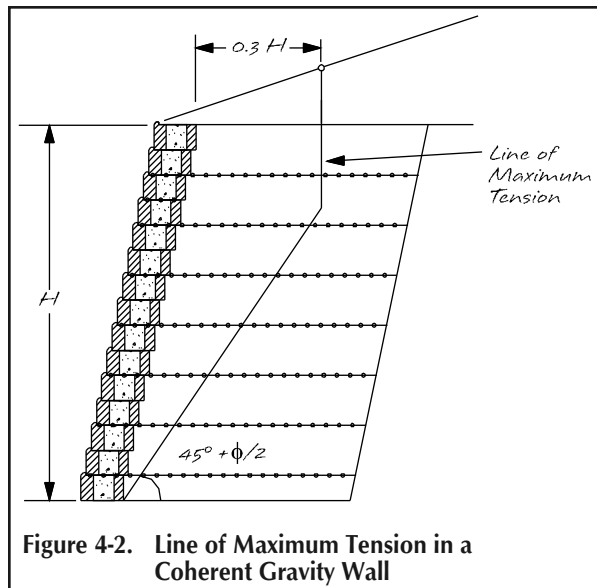

For the wall in Figure 4-3 with a backfill slope of 26° , $K_{ai} = 0.3662$ and the load on the bottom layer of geogrid is:

$$\begin{aligned} F_1 &= (P_{avg}) (d_h) \\ &= (0.5) (P_3 + P_4) (d_3 - d_4) \\ &= (0.5) [(\gamma_i) (K_{ai}) (d_3) \cos(\phi_{wi}) + (\gamma_i) (K_{ai}) (d_4) \cos(\phi_{wi})] (d_3 - d_4) \\ &= (0.5) [(125 \text{ lb/ft}^3) (0.3662) (10.48 \text{ ft}) \cos(20^\circ) \\ &\quad + (125 \text{ lb/ft}^3) (0.3662) (9.21 \text{ ft}) \cos(20^\circ)] (10.48 \text{ ft} - 9.21 \text{ ft}) \\ &= 538 \text{ lb/ft} \end{aligned}$$

$$\begin{aligned} &= (0.5) [(2,002 \text{ kg/m}^3) (0.3662) (3.2 \text{ m}) \cos(20^\circ) \\ &\quad + (2,002 \text{ kg/m}^3) (0.3662) (2.8 \text{ m}) \cos(20^\circ)] (3.2 \text{ m} - 2.8 \text{ m}) (9.81 \text{ m/sec}^2) \\ &= 8,110 \text{ N/m} \end{aligned}$$

Increasing the slope of the backfill from 0° to 26° increased the load on the bottom layer of geogrid by nearly 100%. If the calculated load at any given layer exceeded the allowable design load of the grid, the strength of the grid or additional layers of grid would need to be considered.

When designing a wall with a sloping backfill, start from the bottom of the wall and calculate the maximum d_h as in Example 2-3. But this time, use the depth from the geometric vertical center of the slope above the reinforced soil mass rather than the depth from the top of the wall facing.

Coherent Gravity Walls with Broken Back Slopes

Broken back slopes are very simply non-continuous slopes. They are modeled to more accurately describe a specific site condition. Broken back slopes provide much less force to a wall design than does a full continuous slope because of the greatly reduced soil mass above the wall. Figure 4-4 shows the effective slope above for internal calculations (i_{int}) based on a distribution distance of $2H$. Figure 4-5 shows the effective slope above for external calculations (i_{ext}) based on the distribution distance of H_e . In each, the effective slope will continue to rise as the broken back slope rises. Once the broken back slope rises above the relative distribution length the effective slope (i_{ext} or i_{int}) will match the actual slope above (i). Figure 4-6 shows the effective slopes for broken back slopes that crest over the reinforced mass. Note that the effective slope for internal calculations (i_{int}) is still distributed over a distance of $2H$ but because the slope above the mass exits the back of the mass in a horizontal plane, the effective slope for external calculations (i_{ext}) will be zero degrees. These broken back distribution lengths are taken directly from the NCMA Design Manual of Segmental Retaining Walls.

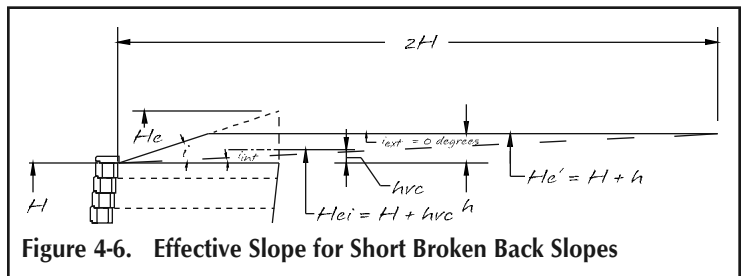
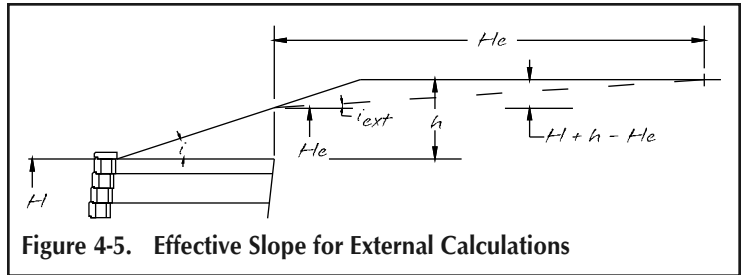
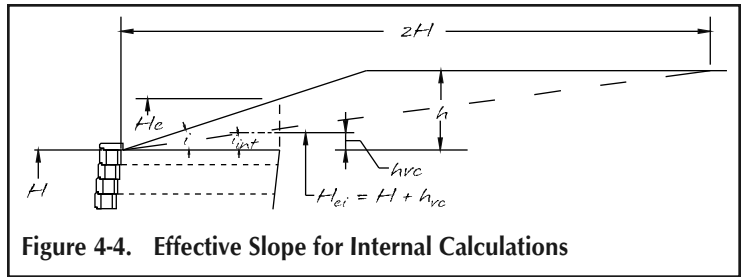

CHAPTER FIVE

Seismic Analysis

Introduction

In seismic design we take a dynamic force and analyze it as a temporary static load. The forces from seismic activity yield both a vertical and a horizontal acceleration. For our calculations, the vertical acceleration is assumed to be zero (Bathurst, 1998, NCMA Segmental Retaining Walls - Seismic Design Manual, 1998). Due to the temporary nature of the loading, the minimum recommended factors of safety for design in seismic conditions are 75% of the values recommended for static design.

The wall performance during the Northridge earthquake in Los Angeles, California and the Kobe earthquake in Japan proves that a soil mass reinforced with geogrid, which is flexible in nature, performs better than rigid structures in real life seismic situations (Columbia University in Cooperation with Allan Block Corporation and Huesker Geosynthetics. "Executive Summary - Seismic Testing - Geogrid Reinforced Soil Structures Faced with Segmental Retaining Wall Block", Sandri, Dean, 1994, "Retaining Walls Stand Up to the Northridge Earthquake").

The following design uses the earth pressure coefficient method derived by Mononobe-Okabe (M-O) to quantify the loads placed on the reinforced mass and the internal components of the structure. Since the nature of segmental retaining walls is flexible, an allowable deflection can be accepted resulting in a more efficient design while remaining within accepted factors of safety.

Pressure Coefficients

The calculation of the dynamic earth pressure coefficient is similar to the static earth pressure coefficient derived by Coulomb, with the addition by Mononobe-Okabe of a seismic inertia angle (θ).

$$K_{ae} = \frac{\left[\frac{\cos^2 (\phi + \omega - \theta)}{\cos (\theta) \cos^2 (\omega) \cos (\phi_w - \omega + \theta)} \right]}{\left[1 + \sqrt{\frac{\sin (\phi + \phi_w) \sin (\phi - i - \theta)}{\cos (\phi_w - \omega + \theta) \cos (\omega + i)}} \right]^2}$$

Where:

- | | | | |
|----------|---|----------|-------------------------|
| ϕ | = peak soil friction angle | i | = back slope angle |
| ω | = block setback | θ | = seismic inertia angle |
| ϕ_w | = angle between the horizontal and the sloped back face of the wall | | |

The seismic inertia angle (θ) is a function of the vertical and horizontal acceleration coefficients:

$$\theta = \text{atan} \left(\frac{K_h}{1 + K_v} \right)$$

Where:

- | | |
|-------|---------------------------------------|
| K_v | = vertical acceleration coefficient |
| K_h | = horizontal acceleration coefficient |

The vertical acceleration coefficient (K_v) is taken to be zero based on the assumption that a vertical and horizontal peak acceleration will not occur simultaneously during a seismic event (Bathurst et al.). The horizontal acceleration coefficient (K_h) is based on the specified horizontal peak ground acceleration (A_0) and the allowable deflection (d) of the wall system. (See equations below) The values for (A_0) typically vary from 0 to 0.4 in our calculations and is defined as the fraction of the gravitational constant g experienced during a seismic event. AASHTO provides recommendations for the acceleration coefficient based on the seismic zone that the retaining wall is being designed for. The allowable deflection (d) represents the lateral deflection that the retaining wall can be designed to withstand during a seismic event. The amount of deflection allowed in the design is based on engineering judgement. However, the typical allowable deflection (d) is approximately 3 in. (76 mm). The equation used to determine the horizontal acceleration coefficient (K_h) varies depending on the amount of deflection allowed and whether it is calculated for the infill soils or the retained soils.



For **Infill** soils:

If $d = 0$, then

$$K_h = (1.45 - A_0) A_0$$

This equation, proposed by Segrestin and Bastic, is used in AASHTO / FHWA guidelines. It is assumed to be constant at all locations in the wall.

If $d > 0$, then

$$K_h = 0.74 A_0 \left(\frac{(A_0) (1 \text{ in})}{d} \right)^{0.25}$$

$$K_h = 0.74 A_0 \left(\frac{(A_0) (25.4 \text{ mm})}{d} \right)^{0.25}$$

This is a standard equation for the horizontal acceleration coefficient based on the Mononobe-Okabe methodology (Mononobe, 1929; Okabe, 1926).

For **Retained** soils if:

If $d \leq 1$, then

$$K_h = \frac{A_0}{2}$$

If $d > 1$, then

$$K_h = 0.74 A_0 \left(\frac{(A_0) (1 \text{ in})}{d} \right)^{0.25}$$

$$K_h = 0.74 A_0 \left(\frac{(A_0) (25.4 \text{ mm})}{d} \right)^{0.25}$$

The following example illustrates the calculation of the dynamic earth pressure coefficient for the infill and retained soils with a typical allowable deflection of 3 in. (76 mm).

Example 5-1

Given:

$$\begin{array}{ll}
 \phi_i & = 34^\circ & \phi_r & = 28^\circ \\
 \phi_{wi} & = 2/3(34^\circ) = 23^\circ & \phi_{wr} & = 2/3(28^\circ) = 19^\circ \\
 d & = 3 \text{ in } (76 \text{ mm}) & \omega & = 12^\circ \\
 i & = 0^\circ & A_o & = 0.4
 \end{array}$$

Find:

The dynamic earth pressure coefficients (K_{ae_i} , K_{ae_r}) for the infill and retained soils.

$$K_{ae_i} = \frac{\left[\frac{\cos^2 (\phi + \omega - \theta)}{\cos (\theta) \cos^2 (\omega) \cos (\phi_w - \omega + \theta)} \right]}{\left[1 + \sqrt{\frac{\sin (\phi + \phi_w) \sin (\phi - i - \theta)}{\cos (\phi_w - \omega + \theta) \cos (\omega + i)}} \right]^2}$$

The first step is to calculate the acceleration coefficients.

$K_v = 0$, based on the assumption that a vertical and horizontal peak acceleration will not occur simultaneously during a seismic event.

To determine K_h , we must look at the allowable deflection (d). Since the allowable deflection is greater than zero, the following equation is used:

$$K_h = 0.74 A_o \left(\frac{(A_o)(1 \text{ in})}{d} \right)^{0.25}$$

$$K_h = 0.74 A_o \left(\frac{(A_o)(25.4 \text{ mm})}{d} \right)^{0.25}$$

$$K_h = 0.74 (0.4) \left(\frac{(0.4)(1 \text{ in})}{3 \text{ in}} \right)^{0.25} = 0.179$$

$$K_h = 0.74 (0.4) \left(\frac{(0.4)(25.4 \text{ mm})}{76 \text{ mm}} \right)^{0.25} = 0.179$$

The seismic inertia angle (θ) is:

$$\theta = \text{atan} \left(\frac{K_h}{1 + K_v} \right) = \text{atan} \left(\frac{0.179}{1 + 0} \right) = 10.1^\circ$$

Finally, the dynamic earth pressure coefficient for the infill is:

$$K_{ae_i} = \frac{\left[\frac{\cos^2 (34 + 12 - 10.1)}{\cos (10.1) \cos^2 (12) \cos (23 - 12 + 10.1)} \right]}{\left[1 + \sqrt{\frac{\sin (34 + 23) \sin (34 - 0 - 10.1)}{\cos (23 - 12 + 10.1) \cos (12 + 0)}} \right]^2} = 0.289$$

The same process is followed in determining the dynamic earth pressure coefficient for the retained soil. Here again, the vertical acceleration coefficient (K_v) is equal to zero. With the allowable deflection greater than 1 inch (25 mm), the horizontal acceleration coefficient is the following:

$$K_h = 0.74 A_o \left(\frac{(A_o) (1 \text{ in})}{d} \right)^{0.25}$$

$$K_h = 0.74 A_o \left(\frac{(A_o) (25.4 \text{ mm})}{d} \right)^{0.25}$$

$$K_h = 0.74 (0.4) \left(\frac{(0.4) (1 \text{ in})}{3 \text{ in}} \right)^{0.25} = 0.179$$

$$K_h = 0.74 (0.4) \left(\frac{(0.4) (25.4 \text{ mm})}{76 \text{ mm}} \right)^{0.25} = 0.179$$

Next, the seismic inertia angle (θ) can be calculated:

$$\theta = \text{atan} \left(\frac{K_h}{1 + K_v} \right) = \text{atan} \left(\frac{0.179}{1 + 0} \right) = 10.1^\circ$$

The dynamic earth pressure coefficient for the retained soil is:

$$K_{ae_r} = \frac{\left[\frac{\cos^2 (28 + 12 - 10.1)}{\cos (10.1) \cos^2 (12) \cos (19 - 12 + 10.1)} \right]}{\left[1 + \sqrt{\frac{\sin (28 + 19) \sin (28 - 0 - 10.1)}{\cos (19 - 12 + 10.1) \cos (12 + 0)}} \right]^2} = 0.377$$

Dynamic Earth Force of the Wall

The dynamic earth force is based on a pseudo-static approach using the Mononobe-Okabe (M-O) method. Figures 5-1 and 5-2 illustrate the pressure distributions for the active force, dynamic earth force increment, and the dynamic earth force. The magnitude of the dynamic earth force is:

$$DF_{dyn} = F_{ae} - F_a$$

Where:

$$F_a = (0.5) (K_a) (\gamma) (H)^2$$

$$F_{ae} = (0.5) (1 + K_v) (K_{ae}) (\gamma) (H)^2$$

The magnitude of the resultant force (F_a) acts at $1/3$ of the height of the wall. Based on full scale seismic testing DF_{dyn} has been found to act at $1/2$ the height of the wall. Based on a rectangular pressure distribution.

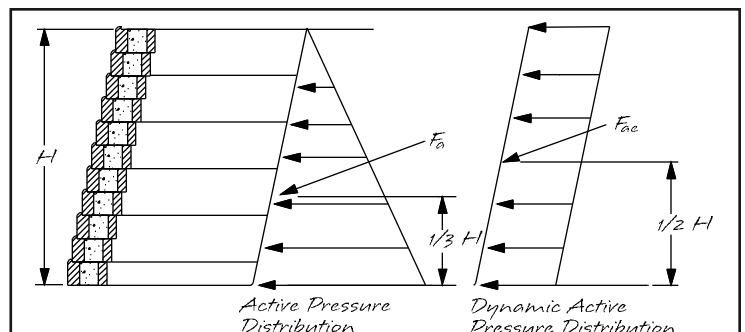

Figure 5-1. Dynamic and Static Active Pressure Distribution

Safety Factors

The minimum accepted factors of safety for seismic design are taken to be 75% of the values recommended for static design.

$$\text{Sliding} > 1.1$$

$$\text{Overturning} > 1.5$$

NOTE: The values 1.1 and 1.5 are based on 75% of the recommended minimum factors of safety for design of conventional segmental retaining walls. (Mechanically Stabilized Earth Walls and Reinforced Soil Slopes Design and Construction Guide Lines, FHWA NHI-00-043).

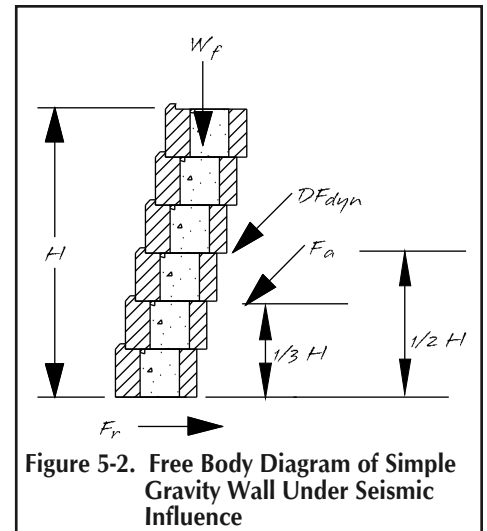

Simple Gravity Wall with Seismic Influence

In seismic analysis, the weight of a simple gravity wall must counteract the static and temporary dynamic forces of the retained soil. Figure 5-2 illustrates the forces on a simple gravity wall during a seismic event. In the following example, the same equilibrium principles apply as in a static gravity wall analysis with additional consideration for the seismic earth force and the allowed reductions in required factors of safety for sliding and overturning.

Example 5-2:

Given:

$$\phi_i = \phi_r = 30^\circ$$

$$\omega = (90 - \beta) = 12^\circ$$

$$A_o = 0.4$$

$$K_{a_i} = 0.2197$$

$$K_{a_r} = 0.2197$$

$$\gamma_{\text{wall}} = 130 \text{ lb/ft}^3 \text{ (2,061 kg/m}^3\text{)}$$

$$K_{a_e_i} = 0.362$$

$$\beta = 78^\circ$$

$$i = 0^\circ$$

$$d = 2 \text{ in. (51 mm)}$$

$$H = 2.54 \text{ ft (0.77 m)}$$

$$\phi = \phi_{wi} = \phi_{wr} = 2/3(\phi) = 20^\circ$$

$$\gamma = \gamma_i = \gamma_r = 120 \text{ lb/ft}^3 \text{ (1,923 kg/m}^3\text{)}$$

$$K_{a_e_r} = 0.362$$

Find:

The safety factor against sliding (SFS) and overturning (SFO).

NOTE: The dynamic earth pressure coefficients $K_{a_e_i}$ and $K_{a_e_r}$ were determined by following the allowable deflection criteria established at the beginning of the section.

The first step is to determine the driving forces exerted by the soil on the wall:

Active earth force:

$$\begin{aligned}
 F_a &= (0.5) (K_a) (\gamma) (H)^2 \\
 &= (0.5) (0.2197) (120 \text{ lb/ft}^3) (2.54 \text{ ft})^2 = 85 \text{ lb/ft} \\
 &= (0.5) (0.2197) (1,923 \text{ kg/m}^3) (0.77 \text{ m})^2 \\
 &= (95 \text{ kg/m}) (9.81 \text{ m/sec}^2) = 1,229 \text{ N/m}
 \end{aligned}$$

Dynamic earth force:

$$\begin{aligned}
 F_{ae} &= (0.5) (1 + K_v) (K_{ae}) (\gamma) (H)^2 \\
 &= (0.5) (1 + 0) (0.362) (120 \text{ lb/ft}^3) (2.54)^2 = 140 \text{ lb/ft} \\
 &= (0.5) (1 + 0) (0.362) (1,923 \text{ kg/m}^3) (0.77)^2 = 2,024.5 \text{ N/m}
 \end{aligned}$$

Dynamic earth force increment:

$$\begin{aligned}
 DF_{dyn} &= F_{ae} - F_a \\
 &= 140 \text{ lb/ft} - 85 \text{ lb/ft} = 55 \text{ lb/ft} \qquad \qquad \qquad = 2,024.5 \text{ N/m} - 1,229 \text{ N/m} = 795.5 \text{ N/m}
 \end{aligned}$$

Resolving the active earth force and the dynamic earth force increment into horizontal and vertical components:

$$\begin{aligned}
 F_{ah} &= (F_a) \cos (\phi_w) \\
 &= (85 \text{ lb/ft}) \cos (20^\circ) = 80 \text{ lb/ft} \qquad \qquad \qquad = (1,229 \text{ N/m}) \cos (20^\circ) = 1,155 \text{ N/m}
 \end{aligned}$$

$$\begin{aligned}
 F_{av} &= (F_a) \sin (\phi_w) \\
 &= (85 \text{ lb/ft}) \sin (20^\circ) = 29 \text{ lb/ft} \qquad \qquad \qquad = (1,229 \text{ N/m}) \sin (20^\circ) = 420 \text{ N/m}
 \end{aligned}$$

$$\begin{aligned}
 DF_{dyn_h} &= (DF_{dyn}) \cos (\phi_w) \\
 &= (55 \text{ lb/ft}) \cos (20^\circ) = 51.7 \text{ lb/ft} \qquad \qquad \qquad = (795.5 \text{ N/m}) \cos (20^\circ) = 747.5 \text{ N/m}
 \end{aligned}$$

$$\begin{aligned}
 DF_{dyn_v} &= (DF_{dyn}) \sin (\phi_w) \\
 &= (55 \text{ lb/ft}) \sin (20^\circ) = 18.8 \text{ lb/ft} \qquad \qquad \qquad = (795.5 \text{ N/m}) \sin (20^\circ) = 272.1 \text{ N/m}
 \end{aligned}$$

The next step is to determine the resisting forces:

Sliding Analysis

Weight of the wall facing:

$$\begin{aligned}
 W_f &= (\gamma_{wall})(H)(d) \\
 &= (130 \text{ lb/ft}^3) (2.54 \text{ ft}) (0.97 \text{ ft}) = 320 \text{ lb/ft} \qquad \qquad \qquad = (2,061 \text{ kg/m}^3) (0.77 \text{ m}) (0.296 \text{ m}) = 4,608 \text{ N/m}
 \end{aligned}$$

Maximum frictional resistance to sliding:

$$\begin{aligned}
 F_r &= (W_f + F_{av} + DF_{dyn_v}) \tan (\phi) \\
 &= (320 \text{ lb/ft} + 29 \text{ lb/ft} + 18.8 \text{ lb/ft}) \tan (30^\circ) = 212.3 \text{ lb/ft} \qquad \qquad \qquad = (4,608 \text{ N/m} + 420 \text{ N/m} + 272.1 \text{ N/m}) \tan (30^\circ) = 3,060 \text{ N/m}
 \end{aligned}$$

Safety factor against sliding (SFS):

$$\begin{aligned}
 SFS_{\text{seismic}} &= \frac{\text{(Force resisting sliding)}}{\text{(Force driving sliding)}} = \frac{F_r}{F_{ah} + DF_{\text{dyn}_h}} \\
 &= \frac{(212.3 \text{ lb/ft})}{(80 \text{ lb/ft} + 51.7 \text{ lb/ft})} = 1.61 \geq 1.1 \text{ ok} \\
 &= \frac{(3,060 \text{ N/m})}{(1,155 \text{ N/m} + 747.5 \text{ N/m})} = 1.61 \geq 1.1 \text{ ok}
 \end{aligned}$$

The factor of safety of 1.21 shows that an AB gravity wall during an earthquake in a seismic zone 4 is stable and does not require reinforcement to prevent sliding. As a comparison, the factor of safety in a static condition is the following:

$$\begin{aligned}
 SFS_{\text{static}} &= \frac{\text{(Force resisting sliding)}}{\text{(Force driving sliding)}} = \frac{F_r}{F_{ah}} = \frac{(W_f + F_{av}) \tan \phi}{F_{ah}} \\
 &= \frac{(320 \text{ lb/ft} + 29 \text{ lb/ft}) \tan (30)}{(80 \text{ lb/ft})} = 2.52 \geq 1.5 \text{ ok} \\
 &= \frac{(4,608 \text{ N/m} + 420 \text{ N/m}) \tan (30)}{(1,155 \text{ N/m})} = 2.52 \geq 1.5 \text{ ok}
 \end{aligned}$$

Overtipping Failure Analysis

In seismic analysis, the moments resisting overturning (M_r) must be greater than or equal to 75% of the static requirement for overturning times the moments causing overturning (M_o).

The moments resisting overturning (M_r):

The weight of the wall, the vertical component of the active force, and the vertical component of the dynamic earth increment force contribute to the moment resisting overturning failure of the wall.

$$\begin{aligned}
 M_r &= (W_f) (W_f \text{arm}) + (F_{av}) (F_a \text{arm}_v) + (DF_{\text{dyn}_v}) (DF_{\text{dynarm}_v}) \\
 &= (W_f) [(X_1) + (0.5) (H) \tan (\omega)] + F_{av} [(t) + (0.333) (H) \tan (\omega)] \\
 &\quad + DF_{\text{dyn}_v} [(t) + (0.5) (H) \tan (\omega)] \\
 &= (320 \text{ lb/ft}) [(0.49 \text{ ft}) + (0.5) (2.54) \tan (12^\circ)] + (29 \text{ lb/ft}) [(0) + (0.97 \text{ ft}) \\
 &\quad + (0.333) (2.54) \tan (12^\circ)] + (18.8 \text{ lb/ft}) [(0) + (0.97 \text{ ft}) + (0.5) (2.54) \tan (12^\circ)] \\
 &= 299.8 \text{ ft-lb/ft} \\
 &= (4,608 \text{ N/m}) [(0.149 \text{ m}) + (0.5) (0.77 \text{ m}) \tan (12^\circ)] + (420 \text{ N/m}) [(0) + (0.296 \text{ m}) \\
 &\quad + (0.333) (0.77 \text{ m}) \tan (12^\circ)] + (272.1 \text{ N/m}) [(0) + (0.296 \text{ m}) + (0.5) (0.77 \text{ m}) \tan (12^\circ)] \\
 &= 1,313.7 \text{ N-m/m}
 \end{aligned}$$

NOTE: (s = setback per block, L = length of geogrid, X_1 = half the block depth)

The moments causing overturning (M_o):

The horizontal components of the active and dynamic forces contribute to the moment causing overturning failure of the wall.

$$\begin{aligned}
 M_o &= (F_h) (F_{aarmh}) + (DF_{dynh}) (DF_{dynarmh}) \\
 &= (F_h) (0.333)(H) + (DF_{dynh}) (0.5)(H) \\
 &= (80 \text{ lb/ft}) (0.333) (2.54 \text{ ft}) + (51.7 \text{ lb/ft}) (0.5) (2.54 \text{ ft}) \\
 &= 133.3 \text{ ft-lb/ft} \\
 &= (1,155 \text{ N/m}) (0.333) (0.77 \text{ m}) + (747.5 \text{ N/m}) (0.5) (0.77 \text{ m}) \\
 &= 584.2 \text{ N-m/m}
 \end{aligned}$$



Safety Factor Against Overturning (SFO):

$$\begin{aligned}
 SFS_{\text{seismic}} &= \frac{(\text{Moments resisting overturning})}{(\text{Moments driving overturning})} = \frac{M_r}{M_o} \geq 1.5 \\
 &= \frac{(299.8 \text{ ft-lb/ft})}{(133.3 \text{ ft-lb/ft})} = 2.25 > 1.5, \text{ ok} \\
 &= \frac{(1,313.7 \text{ N-m/m})}{(584.2 \text{ N-m/m})} = 2.25 > 1.5, \text{ ok}
 \end{aligned}$$

This shows that the gravity wall is adequate with respect to overturning failure. However, if the safety factors were not met, geogrid reinforcement for this wall would be needed to achieve proper factor of safety. Evaluating the wall under static conditions we see that the required factors of safety are also met.

$$\begin{aligned}
 M_r &= (W_f) (W_{farm}) + (F_{av}) (F_{aarmv}) \\
 &= (W_f) [(X_1) + (0.5) (H) \tan(\omega)] + (F_v) [(t) + (0.333) (H) \tan(\omega)] \\
 &= (320 \text{ lb/ft}) [(0.49 \text{ ft}) + (0.5) (2.54) \tan(12^\circ)] + (29 \text{ lb/ft}) [(0) + (0.97 \text{ ft}) \\
 &\quad + (0.333) (2.54) \tan(12^\circ)] \\
 &= 276.5 \text{ ft-lb/ft} \\
 &= (4,608 \text{ N/m}) [(0.149 \text{ m}) + (0.5) (0.77 \text{ m}) \tan(12^\circ)] + (420 \text{ N/m}) [(0) + (0.296 \text{ m}) \\
 &\quad + (0.333) (0.77 \text{ m}) \tan(12^\circ)] \\
 &= 1,210.9 \text{ N-m/m}
 \end{aligned}$$

$$\begin{aligned}
 M_o &= (F_h) (F_{aarmh}) \\
 &= (F_h) (0.333) (H) \\
 &= (80 \text{ lb/ft}) (0.333) (2.54 \text{ ft}) \\
 &= 68 \text{ ft-lb/ft} \\
 &= (1,155 \text{ N/m}) (0.333) (0.77 \text{ m}) \\
 &= 296 \text{ N-m/m}
 \end{aligned}$$

$$SFO_{\text{static}} = \frac{(\text{Moments resisting overturning})}{(\text{Moments driving overturning})}$$

$$= \frac{M_r}{M_o} \geq 2.0$$

$$= \frac{(276.5 \text{ ft-lb/ft})}{(68 \text{ ft-lb/ft})}$$

$$= 4.1 \geq 2.0 \text{ ok}$$

$$= \frac{(1,210.9 \text{ N-m/m})}{(296 \text{ N-m/m})}$$

$$= 4.1 \geq 2.0 \text{ ok}$$

Coherent Gravity Wall with Seismic Influence

Seismic inertial force (P_{ir})

In the external stability analysis of a geogrid reinforced retaining wall during a seismic event, a seismic inertial force (P_{ir}) is introduced. The seismic inertial force is the sum of the weight components that exert a horizontal inertial force within a reinforced soil mass during a seismic event. The three components exerting this inertial force are the block facing, the reinforced soil mass, and the backslope.

$$P_{ir} = K_{hr} (W_f + W_s + W_i)$$

This force along with the dynamic earth increment force combine with the static earth forces from the retained soil and the weight forces from the wall structure to create the conditions during an earthquake.

Factor of Safety against Sliding

Calculating the Factor of Safety against Sliding for a coherent gravity wall follows the same stability criteria as a simple gravity wall. The principle being that the forces resisting sliding must be 1.1 times the forces causing sliding (75% of static Factor of Safety). As can be seen below, the formula for calculating the Factor of Safety against Sliding is the same as the gravity wall analysis with the addition of the seismic inertial force (P_{ir}) and the weight of the reinforced soil (W_s).

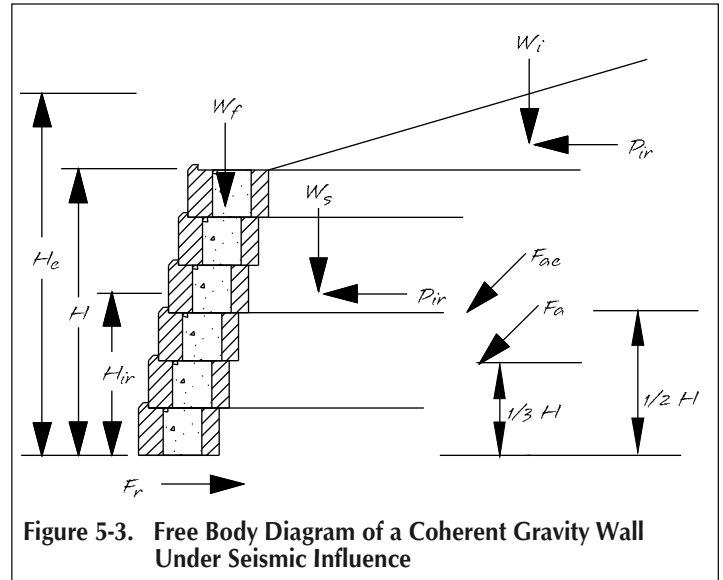

Figure 5-3. Free Body Diagram of a Coherent Gravity Wall Under Seismic Influence

$$SFS_{seismic} = \frac{Fr_{seismic}}{F_{ah} + DFdyn_h + P_{ir}} \geq 1.1$$

Where:

$$Fr_{seismic} = (F_{av} + DFdyn_v + W_f + W_s) \tan(\phi_i)$$

Factor of Safety against Overturning

The Factor of Safety against Overturning is computed in the same way as a simple gravity wall with the addition of the seismic inertial force (P_{ir}) and the weight of the reinforced soil (W_s). The minimum $SFO_{seismic}$ can be defined as 75% of SFO_{static} .

$$SFO_{seismic} = \frac{M_r}{M_o} = \frac{(W_f)(W_f arm) + (W_s)(W_s arm) + (F_{av})(F_a arm_v) + (DFdyn_v)(DFdyn arm_v)}{(F_{ah})(F_a arm_h) + (DFdyn_h)(DFdyn arm_h) + (P_{ir})(H_{ir})} \geq 1.5$$

Example 5-3:

Given:

$\phi_i = \phi_r = 30^\circ$	$\beta = 78^\circ$	$F_a = 1,362 \text{ lb/ft}$	(19,884 N/m)
$W_i = 0 \text{ lb/ft}$	$\omega = (90 - \beta) = 12^\circ$	$DF_{dyn} = 879 \text{ lb/ft}$	(12,850 N/m)
$i = 0^\circ$	$K_{a_i} = 0.2197$	$W_f = 1,243 \text{ lb/ft}$	(18,147 N/m)
$d = 2 \text{ in}$ (51 mm)	$K_{a_r} = 0.2197$	$W_s = 6,345 \text{ lb/ft}$	(92,632 N/m)
$A_o = 0.4$	$K_{a_e_i} = 0.362$	$W_s' = 5,219 \text{ lb/ft}$	(76,269 N/m)
$H = 10.16 \text{ ft}$ (3.10 m)	$K_{a_e_r} = 0.362$	$\gamma_{wall} = 130 \text{ lb/ft}^3$	(2,061 kg/m ³)
$\phi_w = \phi_{wi} = \phi_{wr} = 2/3(\phi) = 20^\circ$	Grid Lengths = 6 ft (1.82 m)	$H_{ir} = 5.08 \text{ ft}$	(1.548 m)
$\gamma = \gamma_i = \gamma_r = 120 \text{ lb/ft}^3$			(1,923 kg/m ³)

Find:

The safety factor against sliding and overturning.

Factor of Safety Against Sliding Analysis

Based on the given information, we must first determine the frictional resistance to sliding (F_r).

$$\begin{aligned}
 F_r &= (F_{av} + DF_{dyn_v} + W_f + W_s) \tan(\phi_i) \\
 &= [(1,362 \text{ lb/ft}) \sin(20^\circ) + (879 \text{ lb/ft}) \sin(20^\circ) + 1,243 \text{ lb/ft} + 6,345 \text{ lb/ft}] \tan(30^\circ) \\
 &= 4,823 \text{ lb/ft} \\
 &= [(19,884 \text{ N/m}) \sin(20^\circ) + (12,850 \text{ N/m}) \sin(20^\circ) + 18,147 \text{ N/m} + 92,632 \text{ N/m}] \tan(30^\circ) \\
 &= 70,437 \text{ N/m}
 \end{aligned}$$

Next, the seismic inertial force is calculated:

$$P_{ir} = K_{hr} (W_f + W_s' + W_i)$$

Since,

$$d = 2 \text{ in}$$
 (51 mm)

$$\begin{aligned}
 K_{hr} &= (0.74) (A_o) \left(\frac{(A_o) (1 \text{ in})}{d} \right)^{0.25} &&= (0.74) (A_o) \left(\frac{(A_o) (25.4 \text{ mm})}{d} \right)^{0.25} \\
 &= (0.74) (0.4) \left(\frac{(0.4) (1 \text{ in})}{2 \text{ in}} \right)^{0.25} &&= (0.74) (0.4) \left(\frac{(0.4) (25.4 \text{ mm})}{51 \text{ mm}} \right)^{0.25} \\
 &= 0.198 &&= 0.198
 \end{aligned}$$

$$\begin{aligned}
 P_{ir} &= 0.198 (1,243 \text{ lb/ft} + 5,219 \text{ lb/ft} + 0) &&= 0.198 (18,147 \text{ N/m} + 76,269 \text{ N/m} + 0) \\
 &= 1,279 \text{ lb/ft} &&= 18,694 \text{ N/m}
 \end{aligned}$$

Finally, the safety factor against sliding can be calculated:

$$\begin{aligned}
 SF_{S_{seismic}} &= \frac{\text{(Forces resisting sliding)}}{\text{(Forces driving sliding)}} = \frac{F_r}{F_{ah} + DF_{dyn_h} + P_{ir}} \geq 1.1 \\
 &= \frac{(4,823 \text{ lb/ft})}{(1,362 \text{ lb/ft}) \cos 20^\circ + (879 \text{ lb/ft}) \cos 20^\circ + 1,279 \text{ lb/ft}} = 1.42 \geq 1.1 \text{ ok} \\
 &= \frac{(70,437 \text{ N/m})}{(19,884 \text{ N/m}) \cos 20^\circ + (12,850 \text{ N/m}) \cos 20^\circ + 18,694 \text{ N/m}} = 1.42 \geq 1.1 \text{ ok}
 \end{aligned}$$

Comparing the seismic SFS to the static SFS below, we again see much higher safety values for static.

$$\begin{aligned}
 \text{SFS}_{\text{static}} &= \frac{(\text{Forces resisting sliding})}{(\text{Forces driving sliding})} = \frac{F_r}{F_{ah}} = \frac{F_r - (DF_{dyn_v}) \tan \phi}{(F_a) \cos(\phi_w)} \\
 &= \frac{(4,823 \text{ lb/ft}) - (173.6 \text{ lb/ft})}{(1,362 \text{ lb/ft}) \cos 20^\circ} = 3.63 \geq 1.5 \text{ ok} \\
 &= \frac{(70,437 \text{ N/m}) - (2,537 \text{ N/m})}{(19,889 \text{ N/m}) \cos 20^\circ} = 3.63 \geq 1.5 \text{ ok}
 \end{aligned}$$

Factor of Safety Against Overturning Analysis

The safety factor against overturning is equal to the moments resisting overturning divided by the moments driving overturning (M_r / M_o) and must be greater than or equal to 1.5 (75% of $\text{SFO}_{\text{static}}$).

The moments resisting overturning (M_r):

$$M_r = (W_t) (W_{t_{\text{arm}}}) + (F_{av}) (F_{a_{\text{arm}_v}}) + (DF_{dyn_v}) (DF_{dyn_{\text{arm}_v}})$$

$$\begin{aligned}
 \text{Where: } W_t &= W_s + W_f \\
 &= (W_t) [0.5 (L + s) + (0.5) (H) \tan(\omega)] + F_{av} [(L + s) + (0.333) (H) \tan(\omega)] \\
 &\quad + DF_{dyn_v} [(L + s) + (0.5) (H) \tan(\omega)]
 \end{aligned}$$

$$\begin{aligned}
 &= (7,588 \text{ lb/ft}) [0.5 (6.0 \text{ ft} + 0.171 \text{ ft}) + (0.5) (10.16 \text{ ft}) \tan(12^\circ)] \\
 &\quad + [(1,362 \text{ lb/ft}) \sin 20^\circ] [6.0 \text{ ft} + 0.171 \text{ ft} + (0.333) (10.16 \text{ ft}) \tan(12^\circ)] \\
 &\quad + [(879 \text{ lb/ft}) \sin(20^\circ)] [6.0 \text{ ft} + 0.171 \text{ ft} + (0.5) (10.16 \text{ ft}) \tan(12^\circ)] \\
 &= 37,002 \text{ ft-lb/ft}
 \end{aligned}$$

$$\begin{aligned}
 &= (110,778 \text{ N/m}) [0.5 (1.82 \text{ m} + 0.053 \text{ m}) + (0.5) (3.10 \text{ m}) \tan(12^\circ)] \\
 &\quad + [(19,884 \text{ N/m}) \sin 20^\circ] [1.82 \text{ m} + 0.053 \text{ m} + (0.333) (3.10 \text{ m}) \tan(12^\circ)] \\
 &\quad + [(12,850 \text{ N/m}) \sin(20^\circ)] [1.82 \text{ m} + 0.053 \text{ m} + (0.5) (3.10 \text{ m}) \tan(12^\circ)] \\
 &= 164,788 \text{ N-m/m}
 \end{aligned}$$

The moments driving overturning (M_o):

$$\begin{aligned}
 M_o &= (F_{ah}) (F_{a_{\text{arm}_h}}) + (DF_{dyn_h}) (DF_{dyn_{\text{arm}_h}}) + (P_{ir}) (H_{ir}) \\
 &= (F_{ah}) (0.333) (H) + (DF_{dyn_h}) (0.5)(H) + (P_{ir}) (5.08 \text{ ft}) \\
 &= [(1,362 \text{ lb/ft}) \cos(20^\circ)] (0.333) (10.16 \text{ ft}) + [(879 \text{ lb/ft}) \cos(20^\circ)] (0.5) (10.16 \text{ ft}) + 1,279 \text{ lb/ft} (5.08 \text{ ft}) \\
 &= 15,023 \text{ ft-lb/ft}
 \end{aligned}$$

$$\begin{aligned}
 &= [(19,884 \text{ N/m}) \cos(20^\circ)] (0.333) (3.10 \text{ m}) + [(12,850 \text{ N/m}) \cos(20^\circ)] (0.5) (3.10 \text{ m}) + 18,694 \text{ N/m} (1.548 \text{ m}) \\
 &= 66,943 \text{ N-m/m}
 \end{aligned}$$

Safety Factor Against Overturning (SFO):

$$\text{SFO}_{\text{seismic}} = \frac{(\text{Moments resisting overturning})}{(\text{Moments driving overturning})} = \frac{M_r}{M_o} \geq 1.5$$

$$= \frac{(37,002 \text{ ft-lb /ft})}{(15,023 \text{ ft-lb/ft})} = 2.46 \geq 1.5 \text{ ok}$$

$$= \frac{(164,788 \text{ N-m/m})}{(66,943 \text{ N-m/m})} = 2.46 \geq 1.5 \text{ ok}$$

Comparing the seismic (SFO) to the below static (SFO):

$$M_r = (W_t)(W_{tarm}) + (F_{av})(F_{aarmv})$$

Where: $W_t = W_s + W_f$

$$\begin{aligned} &= (W_t) [0.5 (L + s) + (0.5) (H) \tan (\omega)] + (F_{av}) [(L + s) + (0.333) (H) \tan (\omega)] \\ &= (7,588 \text{ lb/ft}) [0.5 (6.0 \text{ ft} + 0.171 \text{ ft}) + (0.5) (10.16 \text{ ft}) \tan (12^\circ)] \\ &+ [(1,362 \text{ lb/ft}) \sin 20^\circ] [(6.0 \text{ ft} + 0.171 \text{ ft}) + (0.333) (10.16 \text{ ft}) \tan (12^\circ)] \\ &= 34,821 \text{ ft-lb/ft} \\ &= (110,778 \text{ N/m}) [0.5 (1.82 \text{ m} + 0.053 \text{ m}) + (0.5) (3.10 \text{ m}) \tan (12^\circ)] \\ &+ [(19,884 \text{ N/m}) \sin 20^\circ] [(1.82 \text{ m} + 0.053 \text{ m}) + (0.333) (3.10 \text{ m}) \tan (12^\circ)] \\ &= 145,909 \text{ N-m/m} \end{aligned}$$

$$M_o = (F_{ah})(F_{aarmh})$$

$$= (F_{ah})(0.333)(H)$$

$$= [(1,362 \text{ lb/ft}) \cos (20^\circ)] (0.333) (10.16 \text{ ft})$$

$$= 4,334 \text{ ft-lb/ft}$$

$$= [(19,884 \text{ N/m}) \cos (20^\circ)] (0.333) (3.10 \text{ m})$$

$$= 18,161 \text{ N-m/m}$$

$$SFO_{static} = \frac{(\text{Moments resisting overturning})}{(\text{Moments driving overturning})} = \frac{M_r}{M_o}$$

$$= \frac{(34,821 \text{ ft-lb /ft})}{(4,334 \text{ ft-lb/ft})} = 8.0 \geq 2.0 \text{ ok}$$

$$= \frac{(145,909 \text{ N-m/m})}{(18,161 \text{ N-m/m})} = 8.0 \geq 2.0 \text{ ok}$$

Internal Stability

The factor of safety checks for the internal stability of a geogrid reinforced retaining wall under seismic conditions include the geogrid overstress, geogrid / block connection strength, geogrid pullout from the soil, and localized or top of the wall stability. These calculations are identical to those for a static stability analysis with the exception of the seismic forces introduced which affect the tensile loading on the geogrid.

Factor of Safety Geogrid Tensile Overstress

In order to calculate the Factor of Safety for Geogrid Tensile Overstress, the tensile force on each grid must first be determined. In a seismic event, the sum of the active force (F_a), the dynamic earth force increment (DF_{dyn_i}), and the seismic inertial force (P_{ir_i}) represent the tensile force on each layer of geogrid.

$$F_{id_i} = F_{a_i} + DF_{dyn_i} + P_{ir_i}$$

Where:

$$F_{a_i} = (K_a) \cos (\phi_w) (\gamma) (Ac_i) (0.5)$$

$$DF_{dyn_i} = (0.5)(H_{ej})(K_{ae} - K_a) \cos (\phi_w) (\gamma) (Ac_i)$$

NOTE: This equation comes directly from the NCMA SRW Design Manual (3rd Edition) and can be referred to as the trapezoidal method.

Ac_i = The tributary influence area on each grid layer.

and

$$P_{ir_i} = (K_h) (\gamma) (Ac_i)$$

AASHTO or FHWA projects often use the active wedge method to determine DF_{dyn} .

$$DF_{dyn_i} = (K_h) (WA) \left(\frac{Ac_i}{H_e} \right)$$

AB Walls 10 allows the user to choose either method but is defaulted to use the greater of the two.

We have used full scale seismic testing to determine that the internal seismic pressure closely matches a rectangle shape where the load is evenly distributed between the grid layers relative to their tributary area. This gives values that are not only more accurate, but are easier to design with. This load value is determined by the soil weight based on either the trapezoidal method shown in Figure 5-4 or by the active wedge method shown in Figure 5-5.

The angle of inclination (α_i) of the Coulomb failure surface for the active wedge method:

$$\alpha_i = \operatorname{atan} \left[\frac{-\tan(\phi_i - i) + \sqrt{[\tan(\phi_i - i) (\tan(\phi_i - i) + \cot(\phi_i + \omega)) (1 + \tan(\phi_w - \omega) \cot(\phi_i + \omega))]}{1 + \tan(\phi_w - \omega) (\tan(\phi_i - i) + \cot(\phi_i + \omega))} \right] + \phi_i$$

Determine the Factor of Safety against Tensile Overstress:

$$FS_{\text{overstress}} = \frac{(\text{LTADS})(RF_{\text{cr}})}{F_{\text{id}}}$$

In the calculation of the Factor of Safety Geogrid Tensile Overstress for a seismic event, we do not take a reduction of the geogrid ultimate strength for long-term creep. This is due to the short-term loading during a seismic event.

Geogrid / Block Connection Capacity

The Factor of Safety for Connection Strength is equal to the peak connection strength divided by the tensile force on that layer of grid multiplied by 0.666. We take the reduction on the tensile force due to the reality that some of the tensile force is absorbed by the soil in the influence area.

$$FS_{\text{conn}} = \frac{F_{\text{cs}}}{F_{\text{id}} (0.667)} \geq 1.1$$

Geogrid Pullout from the Soil

The Factor of Safety for Geogrid Pullout from the Soil is:

$$FS_{\text{pullout}} = \frac{F_{\text{gr}}}{F_{\text{id}}} \geq 1.1$$

where,

$$F_{\text{gr}} = 2 (d_g) (\gamma) (Le_d) (C_i) \tan(\phi)$$

The above pullout capacity equation takes into account the geogrid interaction coefficient (C_i) and is calculated based on the length of geogrid embedded beyond the Coulomb failure surface (Le_d).

Localized Stability, Top of the Wall

To determine local or top of the wall stability (SFS and SFO), the wall parameters and soils forces in the unreinforced portion of the retaining wall are focused on. The unreinforced height of the wall (H_t) is simply the total height of the wall minus the elevation at which the last grid layer is placed. The local weight of the facing is:

$$W_f = (H_t) (t) (\gamma_{\text{wall}})$$

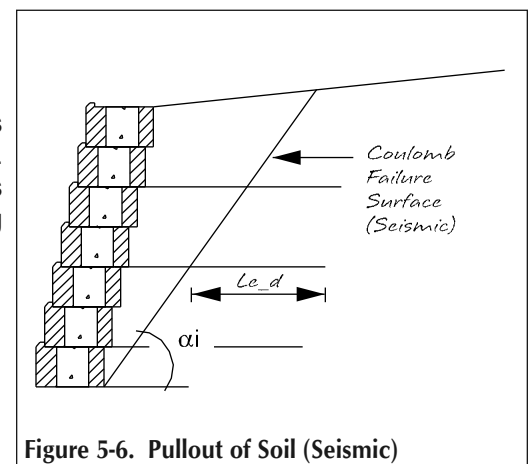
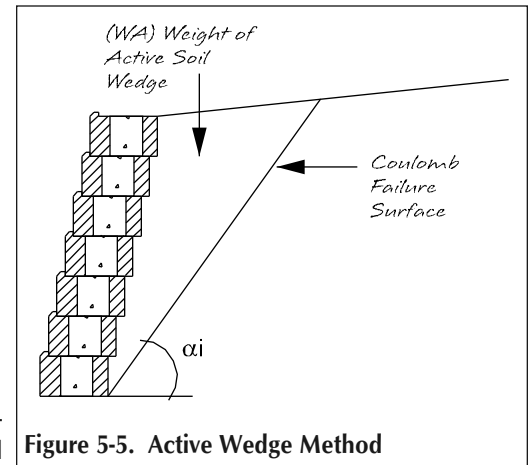
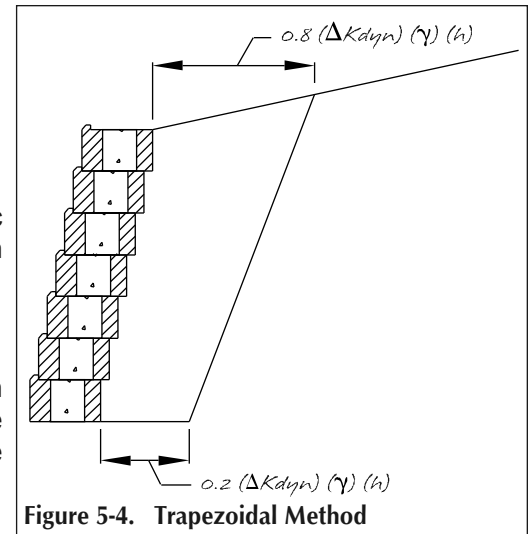

The local sliding resistance (F_r) is an equation based on the Allan Block shear strength, which was developed through empirical test data and is a function of the normal load acting at that point and is the following:

$$F_r = 2,671 \text{ lb/ft} + (W_f) \tan (38^\circ)$$

$$= 38,900 \text{ N/m} + (W_f) \tan (38^\circ)$$

The soil and surcharge forces are as follows:

Active Force: $F_a = (0.5) (K_a) (\gamma) (H_t)^2$
 Dynamic Force: $F_{ae} = (0.5) (1 + K_v) (K_{ae}) (\gamma) (H_t)^2$
 Dynamic Earth Force Infrment: $DF_{dyn} = F_{ae} - F_a$
 Seismic Inertial Force: $P_{ir} = (K_h) (W_f)$
 Finally, the safety factor equations are:

$$SFS_{localstatic} = \frac{F_r}{(F_a) \cos (\phi_w)} \geq 1.5$$

$$SFS_{localseismic} = \frac{F_r}{(F_a + DF_{dyn} + P_{ir}) \cos (\phi_w)} \geq 1.1$$

$$SFO_{localstatic} = \frac{W_f [(H_t/2) \tan \omega + t/2] + (F_a) \sin (\phi_w) [(H_t/3) \tan \omega + t]}{(F_a) \cos (\phi_w) (H_t/3)} \geq 2.0$$

$$SFO_{localseismic} = \frac{W_f [(H_t/2) \tan \omega + t/2] + (F_a) \sin (\phi_w) [(H_t/3) \tan \omega + t] + (DF_{dyn}) \sin (\phi_w) (0.5 H_t + t)}{(F_a) \cos (\phi_w) (H_t/3) + (DF_{dyn}) \cos (\phi_w) (0.5 H_t) + P_{ir} (H_t/2)} \geq 1.5$$

NOTE: Verify local requirements for static and seismic Factors of Safety.

Maximum Allowable Slopes in Seismic Conditions

When designing a wall subject to seismic or static loading the designer should understand that there are limitations to the steepness of unreinforced slopes that can be designed and built above any wall.

In static designs, the maximum unreinforced slope above any wall is limited to the internal friction angle of the soil. For seismic designs, the Mononobe-Okabe (M_O) soil mechanics theory gives designers the seismic earth pressure coefficient (K_{ae}) to apply to their retaining wall by combining the effects of soil strength (ϕ_r), slopes above the wall (i), wall setback (ω), and seismic inertia angle (θ_r). This equation becomes limited by its mathematics when low strength soils, steep slopes, and high seismic accelerations are combined. This may be translated to say that for specific combinations of slope angles, soil strength and seismic acceleration the project changes from a segmental retaining wall design to a slope stability problem. With a closer look at these three limiting variables the maximum allowable slope in seismic conditions is:

$$i_{max} = \phi_r - \theta_r$$

Where: ϕ_r = Soil Friction Angle

θ_r = Seismic Inertial Angle



PHI	A ₀	Maximum Allowable Slope
34	0.2	30.1
34	0.4	24.7
32	0.2	28.1
32	0.4	22.7
30	0.2	26.1
30	0.4	20.7
28	0.2	24.1
28	0.4	18.7

Table 5-1 Maximum Allowable Slopes

The seismic inertial angle is calculated using both the horizontal and vertical acceleration coefficients as discussed on page 46.

When a designer needs to design walls with slopes above steeper than the maximum allowed, they have the option of using the Coulomb Trial Wedge method. This method will provide the active earth force and pressure coefficient to allow the designer to complete the wall design. However, the maximum unreinforced slope described above still holds true. Therefore, if the geometry of the slope exceeds this maximum, they must strongly consider reinforcing the slope above using layers of geogrid and they must review the slope using a global stability program such as ReSSA from ADAMA Engineering (reslope.com), to determine the appropriate length, strength and spacing of the geogrid used to reinforce the slope above.

Trial Wedge Method of Determining Active Earth Pressure

The typical seismic design methodology described in this chapter adopts a pseudo-static approach and is generally based on the Mononobe - Okabe (M-O) method to calculate dynamic earth pressures. As described above in the maximum slope above calculation, there is a very distinct limitation to the M-O method. When the designer inputs a slope above the wall that has an incline angle above that exceeds the internal friction angle of the soil minus the seismic inertial angle, the M-O equation for K_{ae} becomes imaginary due to the denominator outputting a negative value. Therefore, the maximum unreinforced stable slope above is relative to the magnitude of the seismic coefficient and the strength of soil used in the slope.

The Coulomb Trial Wedge method dates back to 1776 when Coulomb first presented his theory on active earth pressures and then again in 1875, when Culmann developed a graphical solution to Coulomb's theory. The Trial Wedge Method has similarities to global stability modeling in that you determine the weight above an inclined wedge behind the wall. By determining the worst case combination of weight and slope angle, the active earth forces for static and seismic conditions can be determined.

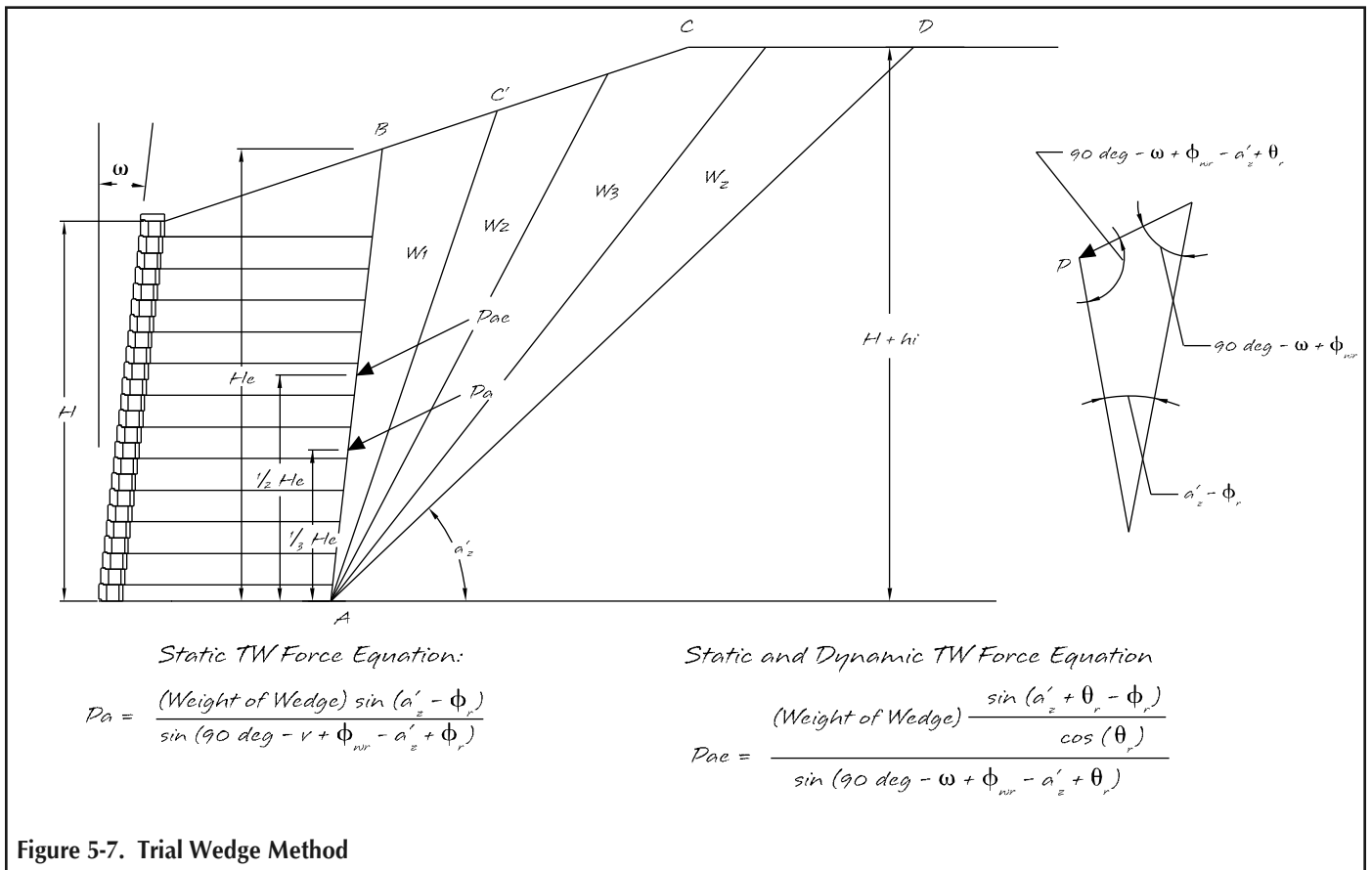

Figure 5-7. Trial Wedge Method

The Trial Wedge method however, does not have limitation due to slope steepness, soil strength or the magnitude of the seismic coefficient. The trial wedge calculations will provide lateral earth pressure forces no matter the geometry. With this in mind, when using the trial wedge method for walls that exceed the M-O maximum slope, it is mandatory that the user analyze the stability of the slope above the wall in a global stability modeling program. It is strongly recommended that the slope above be reinforced with layers of geogrid similar to those in the reinforced mass, with similar spacing and lengths.

The design process is straightforward using a computer program that allows rapid iterations of calculations to determine the maximum pressure, Pa (static) or Pae (seismic). Similar to a global stability analysis, determining the area of the wedges is the first step. The weight of each wedge is determined and applied downward onto the associated inclined wedge plane to determine the forward pressure. As the wedge weights increase and the inclined plane angle continues to rotate, the combination of weight and angle will combine to find a maximum forward force.

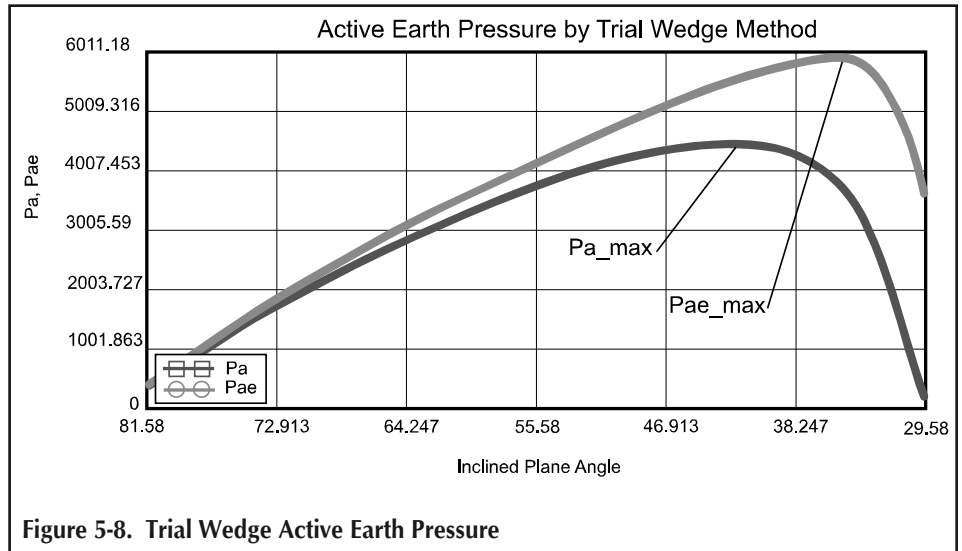

Figure 5-8. Trial Wedge Active Earth Pressure

For external sliding, overturning and bearing safety factor equations, the forces determined by Trial Wedge will replace those calculated by the standard Coulomb and M-O methods. Please note that the calculated Seismic Inertial Force (Pir) is calculated independently of the force method used. This means that Pir is additive to both M-O and Trial Wedge pressure results.

As in the standard Coulomb and M-O methods, the Trial Wedge pressures are applied to the back of the reinforced mass as shown in Figure 5-7 and divided into their horizontal and vertical components. Each are then applied at moment arm locations equal to $1/3 \cdot H_e$ for static and $1/2 \cdot H_e$ for seismic.

$$M_o \text{ (static)} = P_a (\cos) (\phi_{wr}) (1/3) (H_e)$$

$$M_o \text{ (seismic)} = (P_{ae} - P_a) (\cos) (\phi_{wr}) (1/2) (H_e)$$

CHAPTER SIX

Internal Compound Stability

Introduction

Wall designs have typically been limited to internal stability, external stability and bearing analysis by the site civil engineer or the wall design engineer. Additionally, the overall stability of the site is the responsibility of the owner and should be addressed by the owner, by contracting with a geotechnical engineering firm. The geotechnical engineering firm should provide a full global analysis of the entire site including the effects of the segmental retaining walls.

As the design roles become more defined it has become more customary for an Internal Compound Stability (ICS) analysis to be performed. ICS calculations determine the factors of safety for potential slip surfaces which pass through the unreinforced retained soil, the reinforced soil mass and the wall facing within the wall design envelope.

Internal compound stability calculations are limited to a wall design envelope above the base material and back no further than $2(H)$ or $H_e + L$, whichever is greater. This evaluation zone models the slip surface through the wall facing. The slip surface slices the affected grid layers and shears or bulges the SRW facing units. The designers performing ICS calculations can now model the entire wall design envelope in one comprehensive calculation. These calculations include the effects of the infill and retained soil strength, the individual grid layer strengths and spacing and the shear and connection strength the SRW facing brings to the system.

The distinctions between an ICS analysis and a global stability analysis form a clear line of design responsibility. A site civil or wall designer should review the ICS above the base material and through the wall facing within the design envelope for each wall designed on a site. For the larger site stability design, the owner through their geotechnical engineer should be responsible for the global stability of the entire site including the soils below the base material of all walls and structures designed on the project site.

Design Methodology

The Simplified Bishop Method of Slices (see References) is one of the most common analysis methods used in global stability modeling of reinforced slopes. In this method the volume, or weight, of the soil above a slip surface is divided into vertical wedges. The weight of soil is used to calculate the forward sliding forces as well as the sliding resistance due to the frictional interaction with the soil along the slip surface. In the ICS calculations we use the same process of evaluating the soil interaction, but additionally, the ICS analysis combines the resisting forces developed by geogrid layers intersecting the slip arc and the contribution from the SRW facing. Current slope stability modeling either ignores the facing or tries to mimic it by exaggerating a thin semi-vertical soil layer. Internal compound stability calculations analyze both the facing shear capacity and the facing connection capacities to formulate a reasonable facing contribution to the resistance side of the equation. By combining these multiple sliding and resisting forces along the slip surface, a safety factor equation is formed by a ratio of resisting forces to the sliding forces. The end result determines if there is an equilibrium of forces along a particular slip surface.

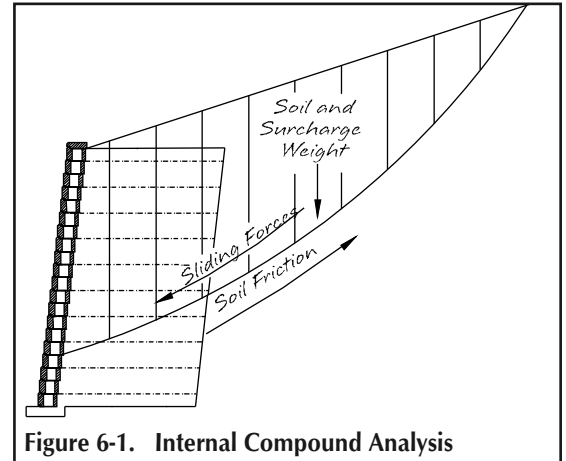

Figure 6-1. Internal Compound Analysis

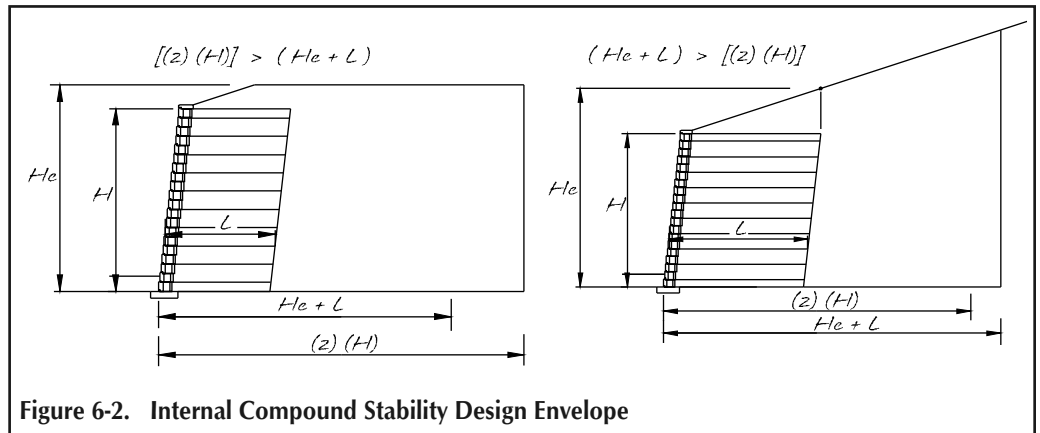

Figure 6-2. Internal Compound Stability Design Envelope

The weight of soil is used to calculate the forward sliding forces as well as the sliding resistance due to the frictional interaction with the soil along the slip surface. In the ICS calculations we use the same process of evaluating the soil interaction, but additionally, the ICS analysis combines the resisting forces developed by geogrid layers intersecting the slip arc and the contribution from the SRW facing. Current slope stability modeling either ignores the facing or tries to mimic it by exaggerating a thin semi-vertical soil layer. Internal compound stability calculations analyze both the facing shear capacity and the facing connection capacities to formulate a reasonable facing contribution to the resistance side of the equation. By combining these multiple sliding and resisting forces along the slip surface, a safety factor equation is formed by a ratio of resisting forces to the sliding forces. The end result determines if there is an equilibrium of forces along a particular slip surface.

Safety Factor of ICS

The following equation calculates the Factor of Safety of Internal Compound Stability.

$$= (\Sigma F_r + \Sigma \text{Facing} + \Sigma F_{gr}) / (\Sigma F_s + \Sigma F_{dyn})$$

Where:

- ΣF_r = sum of soil resisting forces
- ΣFacing = sum of facing contribution
- ΣF_{gr} = sum of geogrid contribution
- ΣF_s = sum of sliding force
- ΣF_{dyn} = sum of sliding forces due to seismic loading

Soil Sliding and Resisting Forces

As mentioned earlier, the Simplified Bishop Method of Slices is used to determine first the weight of the soil above the slip surface and then the sliding and resisting forces due to that soil weight along the slip surface. Figure 6-3 shows a typical section through the evaluation zone for ICS calculations. The vertical slices in the soil above the slip arc represent the individual portions of soil analyzed using Bishop's theory. We will determine the weights and forces relative to one soil slice or wedge as an example. For a complete Simplified Bishop Method of Slices the designer would follow the same calculations for each individual soil wedge and at the end, sum them all together.

In Bishop modeling the soil wedges can be calculated as individual parts due mainly to Bishop's assumption that the vertical frictional forces between soil wedges are neglected, meaning that for design purposes there is no interaction between individual soil wedges. Therefore, the individual soil

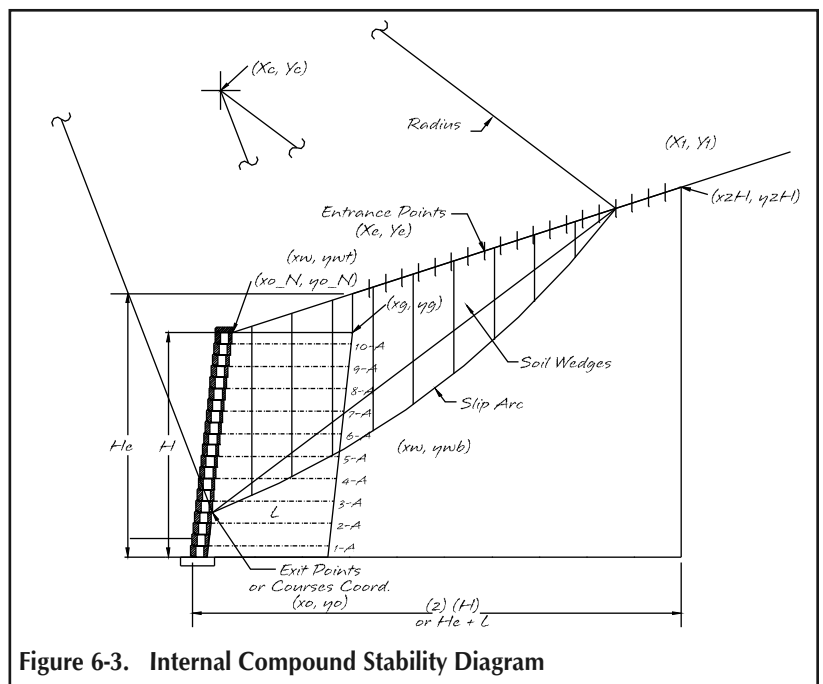

Figure 6-3. Internal Compound Stability Diagram

wedge weight (W) is determined simply by multiplying the volume of soil in that wedge by the unit weight of the soil. To determine the individual wedge volumes the designer must determine the exact geometry of the wall section and the slip arc to be evaluated. This is complex geometry that varies for every slip arc so it is a very difficult calculation to perform by hand. Please note that the thinner the wedge slice is the less the loss of weight is in the calculations. That is, the bottom of each wedge is considered a straight cord, not an arc, for ease of calculations. The lost soil weight is the area below the bottom cord and arc, and is negligible when the wedges are thinner.

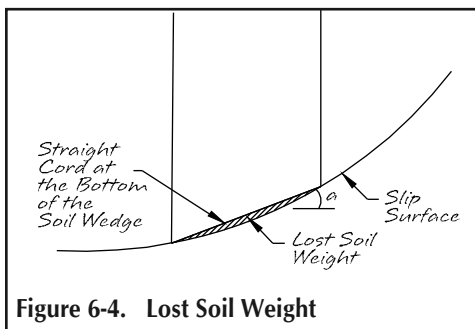

Figure 6-4. Lost Soil Weight

Once the wedge weight is determined the forward sliding force (F_s) is calculated by multiplying it by the sine of the angle below the soil wedge (α), where α is defined as the angle between horizontal and the bottom cord of each soil wedge; α is different for each wedge due to the relative location of each wedge along the slip surface.

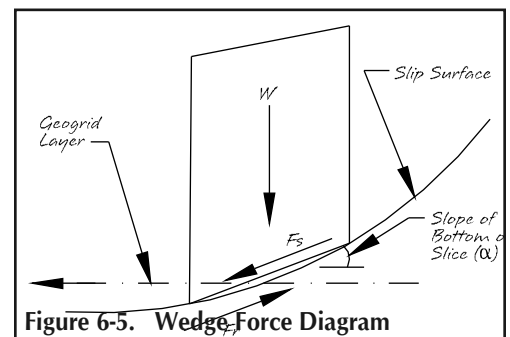

Figure 6-5. Wedge Force Diagram

Sliding Force:

$$F_s = (\text{Weight Wedge}) \sin (\alpha)$$

Compare for a moment two wedges, $W_4 = 1000 \text{ lb/ft}$ (14.6 kN/m) and $W_{17} = 100 \text{ lb/ft}$ (1.46 kN/m). The first (W_4) is near the bottom of the slip arc where the arc ends near the facing and is relatively flat and therefore the α angle is relatively small, say 10 degrees. The other (W_{17}) is near the top of the slip arc where the arc is steeper and therefore the α angle is steeper, say 60 degrees. The sine (α) term acts as a percentage of forward movement, i.e. the flatter the α angle the smaller percentage:

$$F_{s_4} = (W_4) \sin (10 \text{ degrees}) = 1000 \text{ lb/ft} (0.174) \\ \mathbf{17.4\% \text{ of } (1000 \text{ lb/ft}) = 174 \text{ lb/ft} (2.54 \text{ kN/m})}$$

$$F_{s_{17}} = (W_{17}) \sin (60 \text{ degrees}) = 100 \text{ lb/ft} (0.866) \\ \mathbf{86.6\% \text{ of } (100 \text{ lb/ft}) = 86.6 \text{ lb/ft} (1.26 \text{ kN/m})}$$

The sliding resisting force (F_r) is calculated by multiplying the wedge weight by tangent of the internal friction angle of soil, which is commonly used for the soil frictional interaction coefficient. However, Bishop's method then divides this term by a geometric equation called m_α ; m_α is a relationship between the strength of the soil and the relative angle of slip (α) for each wedge and is more clearly defined in global stability text books or global stability modeling programs such as ReSSa.

Sliding Resisting Force (F_r):

$$F_r = (\text{Weight Wedge}) \tan (\phi) / m_\alpha$$

Where:

$$m_\alpha = \cos (\alpha) + [\sin (\alpha) \tan (\phi)] / FS_i$$

And FS_i is the initial safety factor used to start the iteration process.

Generally, the Simplified Bishop procedure is more accurate than the Ordinary Method of Slices, but it does require an iterative, trial-and-error solution for the safety factor. Therefore, the designer needs to approximate what the safety factor will be for the final resulting slip surface. The closer the initial approximation is to the actual safety factor, the less iteration that will be required. This iteration process is standard for a Bishops calculation and again stresses the point that it is difficult to do hand calculations.

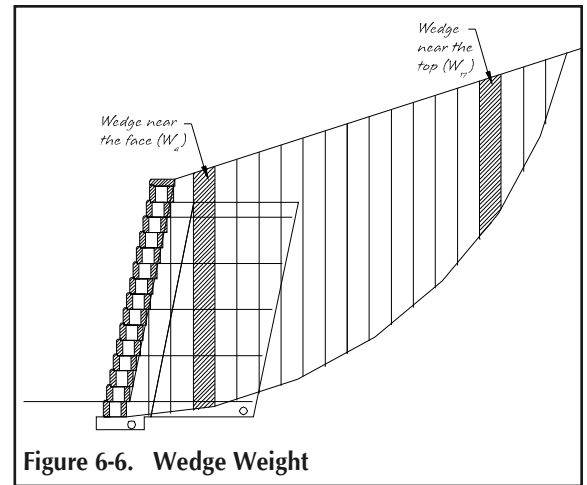

Figure 6-6. Wedge Weight

Modeling Multiple Soil Layers Behind Wall

Generally, a single soil type is very standard with retaining wall designs. As walls increase in height, the potential for multiple soil layers to be present behind the wall increases. Each of these soil layers may have a different friction angle ($\phi_{i_1, 2, 3}$ or $\phi_{r_1, 2, 3}$) and unit weight (γ) that could change the sliding forces ($\gamma_{i_1, 2, 3}$ or $\gamma_{r_1, 2, 3}$) calculated earlier. It would not be uncommon for a wall designer to require wall rock, gravel fill or No Fines Concrete for the lower half, and site soils for the upper half of the wall. For an indepth discussion about no-fines concrete see Appendices D & E.

Figure 6-7 shows the 3 different soil layers in the infill soil as $I_1, I_2,$ and I_3 as well as the retained layers which may not have the same heights as the infill heights ($R_1, R_2,$ and R_3). Looking at the different wedges in each soil layer, there can be a change in the amount of force in the ICS calculation as the previous example had shown.

The weight of each soil layer multiplied by the area of each wedge within that particular soil type determines the weight above each slip arc. Depending on the unit weight of each soil, this calculation could vary from the single soil layer in the previous example. The force that acts on the slip arc can now be found as the previous example did.

$$\begin{aligned}
 F_{s_4} &= (W_1 + W_2 + W_3) \sin(10 \text{ degrees}) = 1100 \text{ lb/ft} (0.174) \\
 &= \mathbf{17.4\% \text{ of } (1100 \text{ lb/ft}) = 191 \text{ lb/ft}} \\
 &= 16.07 \text{ kN/m} (0.174) \\
 &= \mathbf{17.4\% \text{ of } (16.07 \text{ kN/m}) = 2.79 \text{ kN/m}}
 \end{aligned}$$

$$\begin{aligned}
 F_{s_{17}} &= (W_4) \sin(60 \text{ degrees}) = 100 \text{ lb/ft} (0.866) \\
 &= \mathbf{86.6\% \text{ of } (100 \text{ lb/ft}) = 86.6 \text{ lb/ft}} \\
 &= 1.46 \text{ kN/m} (0.866) \\
 &= \mathbf{86.6\% \text{ of } (1.46 \text{ kN/m}) = 1.26 \text{ kN/m}}
 \end{aligned}$$

While analyzing different soil layers within the wall envelope may have a minimal impact on most wall designs, using this on a slope stability calculation can remain very beneficial. Although AB Walls 10 does not run a global stability analysis, the ability to use multiple soil layers in the ICS portion of the program will provide the designer greater flexibility. Currently, the multiple soil layer option is only available in an ICS calculation and will not influence external and internal calculations. For external and internal calculations, the AB Walls program will use the lowest of the three infill and retained friction angles the user defines.

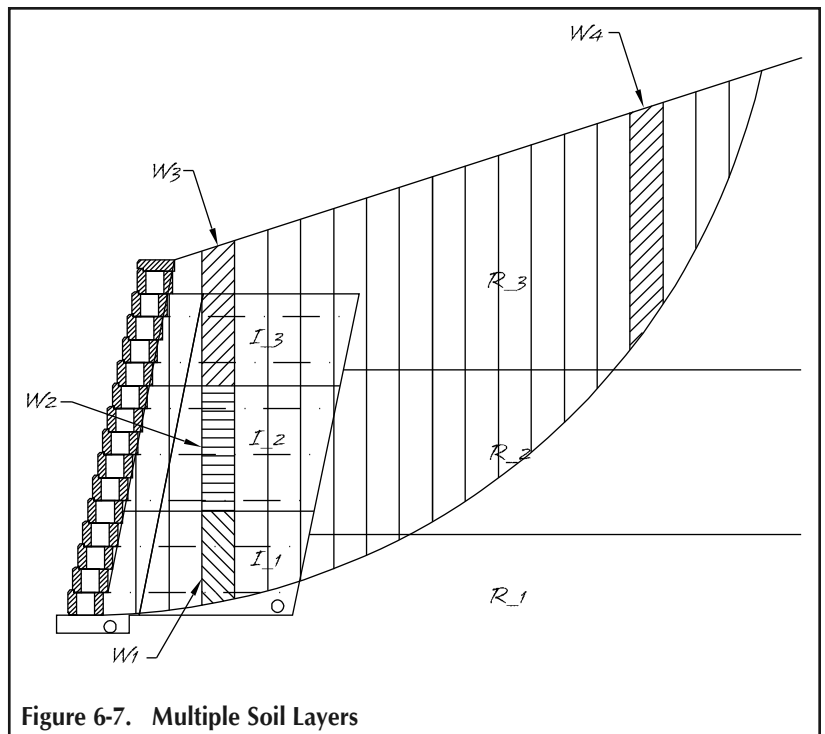

Figure 6-7. Multiple Soil Layers

Surcharges and Seismic Forces

Surcharge and seismic forces are calculated very similarly in a Bishop's model. Surcharges, whether live or dead are simply added to the weights of the individual soil wedges. It should be noted that in an ICS calculations there is no distinction between live and dead load. By handling it in this manner the wedge weight term is increased by the relative weight of the surcharge and is then carried through the Sliding Force (F_s) and the Sliding Resisting Force (F_r) calculations. The designer should be careful to analyze where the surcharges are applied so they add that weight to only the effected soil wedges.

Therefore, the Sliding Forces and Sliding Resisting Force equations are redefined as:

$$\text{Sliding Force:} \quad F_s = (\text{Weight Wedge} + \text{Weight Surcharge}) \sin(\alpha)$$

$$\text{Sliding Resisting Force:} \quad F_r = (\text{Weight Wedge} + \text{Weight Surcharge}) \tan(\phi) / m_\alpha$$

The Seismic Force (F_{dyn}) for a particular slip surface is additive to the Sliding Force (F_s) and is calculated by multiplying F_s by the horizontal acceleration coefficient (k_h); k_h is defined in **Chapter 5, Seismic Analysis**.

$$F_{dyn} = (F_s) (k_h) \quad \text{or for all wedges:} \quad \sum F_{dyn} = \sum F_s (k_h)$$

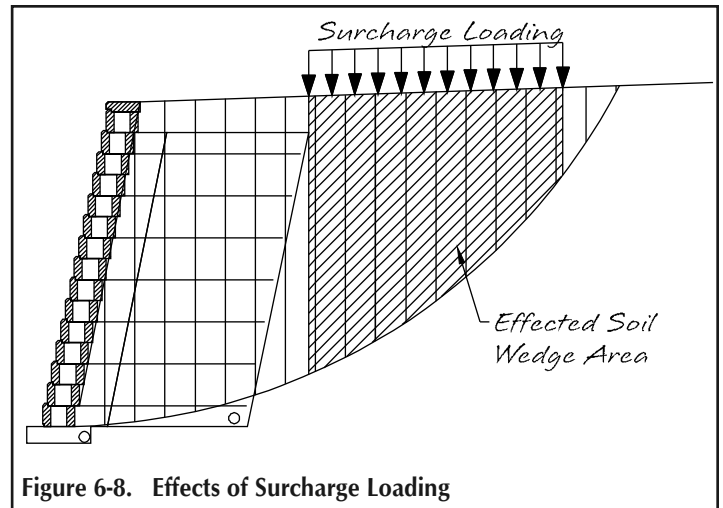

Geogrid Contribution (F_{gr}):

It would stand to reason that if a layer of geogrid is passed through by a slip arc, that the geogrid strength would increase the safety factor or stability of that slip surface. Therefore the relative geogrid interaction (F_{gr}) will be directly added to the resisting side of the equilibrium equation. The grid interaction in this calculation is directly effected by the geogrid spacing. If grid layers are closer together there is a higher likelihood of grid layers being passed through by the slip surface, thus providing more geogrid interaction. The greater the grid spacing the greater possibility of the slip surface falling between grid layers and thus not increasing the slip surfaces stability.

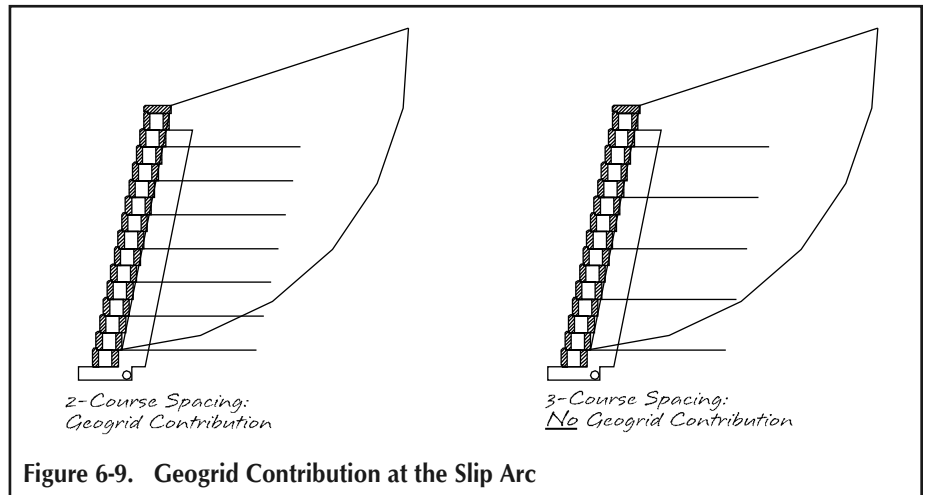

Figure 6-9. Geogrid Contribution at the Slip Arc

The horizontal resistance forces due to geogrid layers that intersect the slip arc are determined by the lesser of either the pullout of soil strength or the long term allowable load strength (LTADS) of the geogrid. Both are defined in the Internal Stability section of Chapter 2. The pullout of soil is calculated by determining the embedment length (L_e) on either side of the slip surface and combining it with the confining pressure, or normal load, from the soil above.

The designer should consider that there are two sides of the slip arc to consider when calculating the geogrid contribution. If the slip arc breaks free from the soil resistance along the slip surface, it will engage the affected geogrid layers. The grid layers can fail in three ways. First the grid can be pulled out from the soil on the retained side of the slip surface. Second, the geogrid layer can be pulled out from the soil on the sliding side of the slip surface. But on this side, the designer must take into account that the end of the grid is connected to the facing. Therefore the total pullout strength on the sliding wedge side is the connection strength plus the pullout of soil. This is a very unlikely way for the grid to fail because this combination will most always be greater than the rupture strength of the grid (limited to the LTADS). Third, the grid can rupture if the pullout of soil strengths exceeds the LTADS of any affected layer.

Calculations show that it is most likely that if a slip occurs some layers will pullout from the retained side and at the same time some layers will rupture.

The designer should analyze each layer of effected geogrid for the three failure modes to determine the lesser for each layer, and then the sum of these lesser amounts becomes the ΣF_{gr} value.

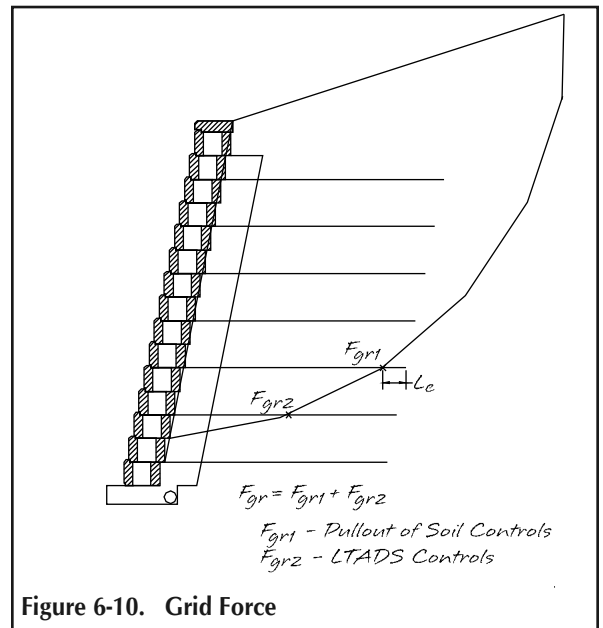

Figure 6-10. Grid Force

Wall Facing Contribution (Facing):

One element of the ICS calculations is the inclusion of facial stability to add to the sliding resistance. The stability of the wall facing has typically been ignored in global modeling due to the complexity of modeling a segmental retaining wall into a slope stability computer program.

Wall facing stability is provided by the interlocking shear between block and by the connection capacity between block and geogrid. Both are directly related to the spacing of the geogrid layers and the amount of normal load above the area in question. The closer together the reinforcement layers are, the more stable the facing becomes in both shear and connection strength. The maximum spacing between grid layers that can be found within the industry is around 32 in. (812 mm). However, past experience has shown that retaining walls that have geogrid layers spaced too far apart do not yield the best design for a wall. Problems associated with excess settlement, deflection and bulging may be experienced. Allan Block recommends a geogrid spacing of 16 in. (406 mm) or less. Closer spacing of lower strength reinforcement is a more efficient way of distributing the loads throughout the mass, which creates a more coherent structure.

Please note that the designer must evaluate both the stability provided by the geogrid connection and the shear strength of the block units, but can only use the lesser of the two in the ICS safety factor equation. Understanding that these two stabilizing forces are interconnected is a benefit to the designer of reinforced segmental retaining walls.

Facing Stability from Geogrid Connections

In the internal compound stability analysis, when the slip arc travels through the wall face at a grid layer we can safely assume that the full connection capacity is available to resist the sliding. However, the grid layers at the face that are above and below the slip arc will also provide some resistance and increase stability. Using a maximum influence distance of 32 in. (812 mm) from the slip arc, a percentage of the grid connection is used in calculating the contribution from block to grid connections when evaluating facial stability. Here are a few examples showing different spacing and slip arc locations.

In **Case A** the slip arc is directly above a layer of geogrid and there are two layers that fall within the influence zone of 32 in. (812 mm) on either side of the slip arc. Looking at how the percentages are distributed, 75% of Grid 2A and 25% of Grid 3A connection strength capacities can be in the analysis of the wall facing. Assuming a full 8 in. (200 mm) tall unit.

Case B has three course spacing between grids and the slip arc intersecting the wall face at a geogrid layer. Therefore 100% of Grid 3A and 25% of Grids 2A and 4A connection strength capacities can be included.

Case C illustrates the boundary layers. The slip arc is towards the bottom of the wall, which means the bottom portion of the influence zone actually includes the bottom of the wall. Grid connection strength capacities are easily identified at 25% of Grid 3A and 75% of Grids 1A and 2A. However, because the slip arc is located towards the bottom of the wall we can also include 50% of the frictional sliding resistance between the Allan Block unit and the gravel base.

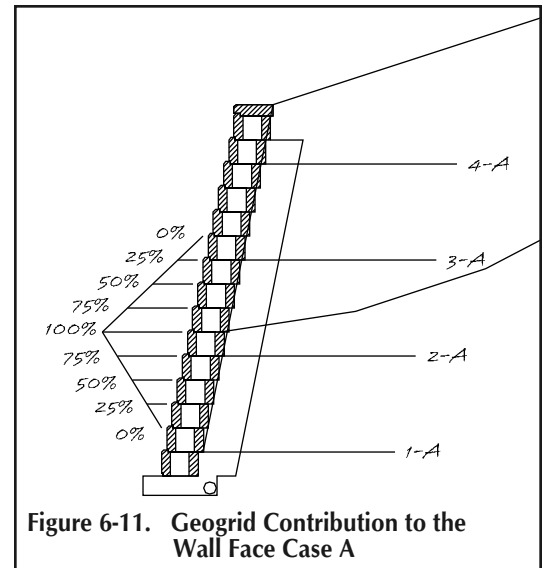

Figure 6-11. Geogrid Contribution to the Wall Face Case A

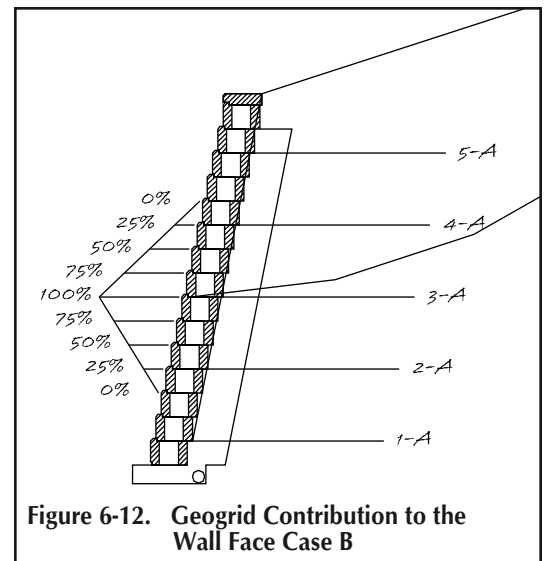

Figure 6-12. Geogrid Contribution to the Wall Face Case B

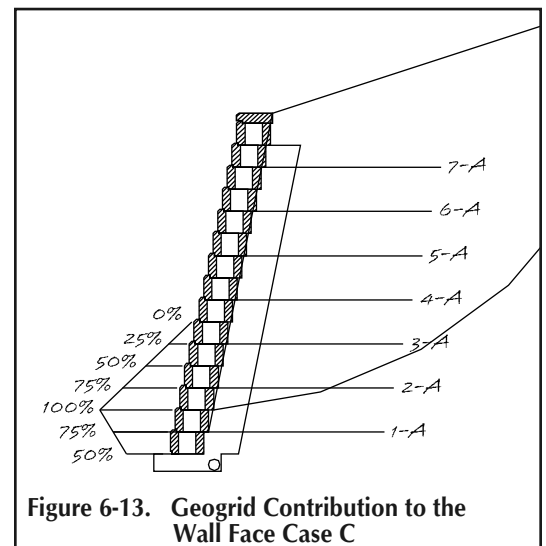

Figure 6-13. Geogrid Contribution to the Wall Face Case C

Facing Stability from Block Shear Strength

Shear interaction between units is easily calculated by understanding that the greater the normal load above a particular joint, the greater the block-to-block shear strength becomes. The tested shear strength equation comes from each SRW manufacture in the form of an ASTM D6916 test (also known as SRW-2 and is included in the appendices), which determines the block-grid-block shear resistance and block-block shear resistance relative to the normal load above that joint.

The first thing a designer should do is determine if the slip surface in question passes through the facing at a geogrid layer. If it does the assumption is made that the facing is 100% stable due to the connection strength with the geogrid and thus the designer can consider adding the tested block-grid-block shear strength of that joint in the analysis of the wall facing.

If the slip surface passes through the facing between grid layers a rotational moment develops between grid layers, with the lower grid layer forming a pivot point for the potential wall facing bulge. Summing the moments about this pivot point the designer can determine if the normal load at that joint is substantial enough to resist the upward rotational effect caused by the sliding forces. If there is sufficient normal load to resist the rotational effect the block will not uplift and the designer can consider adding the full block-block shear strength into the sliding resistance. However, if the normal load is overcome by the rotational uplift, the wall facing will pivot forward and the shear strength of the block cannot be added to the resistance.

Ultimately, this forward rotation will engage the geogrid connection strength from the grid layer above which will act to restrain the facing. If the wall continues to rotate, more uplift will occur and a forward bulge will form between layers and eventually a localized wall failure will occur.

Contribution from the Wall Face

As mentioned earlier, the designer cannot take both the facing stability from the geogrid connection and block shear when totaling up the resisting force. Only one will need to fail before instability of the wall face occurs. Therefore, the one with the least resisting force is the controlling face contribution and is used in the ICS safety factor calculation. The basis of this approach relies on a simple theory that as reinforcement layers are placed closer together, the facing becomes more rigid. The more rigid the facing is made by the connection contribution, the more likely that the shear strength at the evaluated course will control. Likewise, as the geogrid spacing is increased, the connection contribution is lessened thus causing the connection contribution to control.

The following is an example of evaluating ICS for a give set of site and soil conditions. Please note that a full global stability review should be obtained by the owner. These types of calculations require hundreds of thousands of iterations, while evaluating tens of thousands of slip arcs.

Example 6-1:

Looking at Diagram Ex. 6-1 and given the following:

$$\begin{aligned} \beta &= 78^\circ & \gamma &= 120 \text{ lb/ft}^3 \quad (19 \text{ kN/m}^3) \\ \phi_i &= 30^\circ & A_0 &= 0.25 \\ \phi_r &= 28^\circ \end{aligned}$$

Geogrid is spaced 2 courses apart and a minimum length of 12 ft (3.66 m). The LTADS for this example is approximately 1,008 lb/ft (14.7 kN/m).

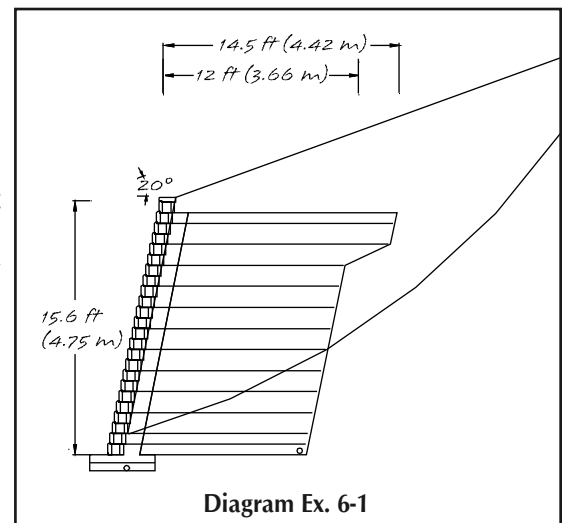
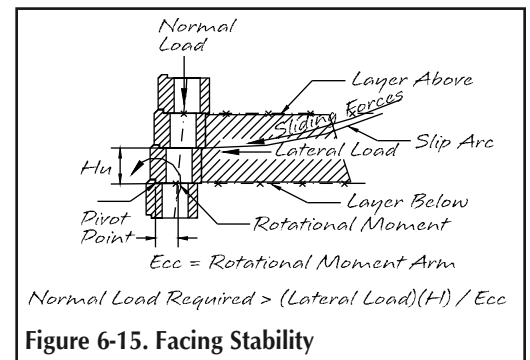
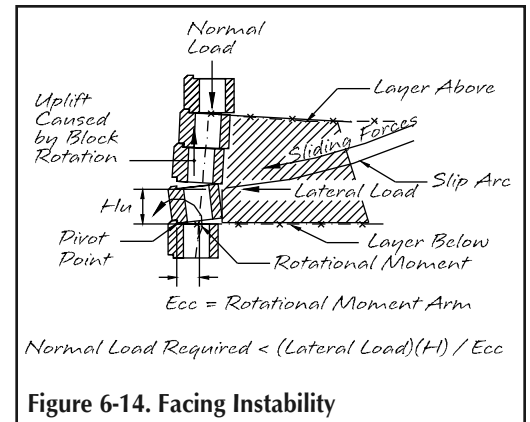

Reviewing the full ICS analysis, it is determined that the minimum Factor of Safety for ICS occurs between the 2nd and 3rd course of blocks.

The following summarizes the results for the slip arc with the minimum Factor of Safety for ICS:

$$\begin{aligned}\Sigma F_r &= \text{sum of soil resisting forces} \\ &= 18,156 \text{ lb/ft} \quad (265 \text{ kN/m})\end{aligned}$$

Σ Facing = sum of facing contribution (either geogrid connection or shear)

$$\Sigma V_u = \text{sum of block shear} = 4,082 \text{ lb/ft} \quad (59.6 \text{ kN/m})$$

$$\Sigma \text{ Conn} = \text{sum of connection} = 4,819 \text{ lb/ft} \quad (70.4 \text{ kN/m})$$

$$\Sigma \text{ Facing} = 4,082 \text{ lb/ft (minimum of the shear and connection)} \quad (59.6 \text{ kN/m})$$

$$\begin{aligned}\Sigma F_{gr} &= \text{sum of geogrid contribution} \\ &= 2,791 \text{ lb/ft} \quad (40.7 \text{ kN/m})\end{aligned}$$

$$\begin{aligned}\Sigma F_s &= \text{sum of sliding force} \\ &= 17,608 \text{ lb/ft} \quad (257 \text{ kN/m})\end{aligned}$$

$$\begin{aligned}\Sigma F_{dyn} &= \text{sum of sliding forces due to seismic loading} \\ &= 1,585 \text{ lb/ft} \quad (23.1 \text{ kN/m})\end{aligned}$$

Safety Factor of ICS

$$\begin{aligned}&= (\Sigma F_r + \Sigma \text{ Facing} + \Sigma F_{gr}) / (\Sigma F_s + \Sigma F_{dyn}) \\ &= \frac{(18,156 \text{ lb/ft} + 4,082 \text{ lb/ft} + 2,791 \text{ lb/ft})}{(17,608 \text{ lb/ft} + 1,585 \text{ lb/ft})} \\ &= 1.304\end{aligned}$$

$$\begin{aligned}&= \frac{(265 \text{ kN/m} + 59.6 \text{ kN/m} + 40.7 \text{ kN/m})}{(257 \text{ kN/m} + 23.1 \text{ kN/m})} \\ &= 1.304\end{aligned}$$

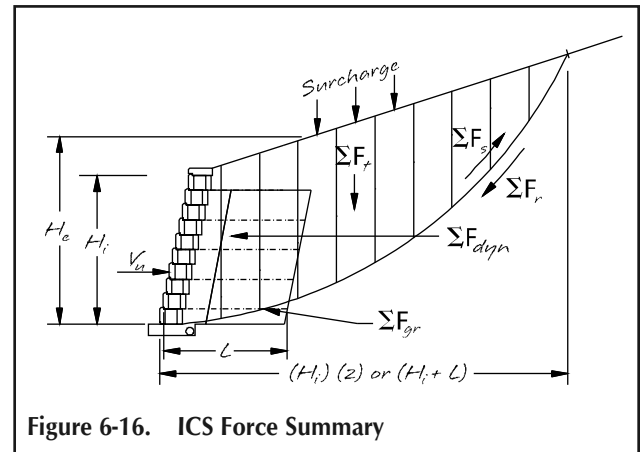

Figure 6-16. ICS Force Summary

Safety Factors and Design Approach

The minimum safety factor for Internal Compound Stability is 1.3 for static conditions and 1.1 for seismic. If after completing the analysis the safety factors are below these standards, the wall design will need to be revised. Please note that to provide a conservative expanded review for a geogrid reinforced retaining wall when analyzing ICS, cohesion is not considered in the methodology presented. Most global stability computer programs provide for the engineer to include a value for cohesion, which would dramatically change the final numbers. Additionally most global stability programs have not provided a detailed approach to contributions from the wall facing and therefore the exact results will be difficult to duplicate when trying to run a comparative review with off the shelf GS software. The following provides a few design options to increase factors of safety for Internal Compound Stability:

1. **Use select backfill:** It has been well documented that using select soils with higher internal strength as backfill in the infill area results in a better wall with increased stability and performance. This will also improve the internal compound stability as well and should be one of the first recommendations.
2. **Additional geogrid reinforcement layers:** Decreasing the spacing between the geogrid reinforcement will force the slip surface to intersect more geogrid layers which will increase the safety factor. The wall facing stability will also improve and will have a direct enhancement in the internal compound stability analysis.
3. **Lengthen the geogrid reinforcement:** Lengthening the geogrid will, again, force the slip surface to intersect more layers of geogrid and ultimately force the slip surface deeper into the evaluation zone. However, this will require additional excavation, and out of the three design options will typically cost the most.
4. **Addition of geogrid in the slope above the wall:** For slopes above the wall, adding geogrid reinforcement within the slope may improve Internal Compound Stability. The length and spacing of these grids will depend on the site conditions and should be done in cooperation with the geotechnical engineer of record.

CHAPTER SEVEN

Complex Composite Structures

Introduction

Complex Composite Structures will be defined as walls that the engineer needs to evaluate as a single wall section with two distinctly different structures positioned one on top of the other. Engineers are often faced with situations that simply do not fit into the straight forward scenarios found in published design methods for SRW projects. The following provides a path to analyze more complicated applications that we will refer to as Complex Composite Structures (CCS). These are identified as complex because they are structures that are a combination of more than one uniform structure. They are composite structures because they rely on multiple materials to resist driving forces to create a safe and effective retaining wall solutions. Typical current design approaches incorporate a similar method when they calculate the top of wall stability for the gravity wall above the top layer of geogrid. This analysis will be presented in a working stress design approach, but could easily be adapted to a limit states approach. Currently we have found that lacking any clear direction to evaluating these types of structures, engineers are faced with having to use their best judgement to create a reasonable analysis for their unique application. This approach provides a more refined method to ensure your design meets the performance standards expected.

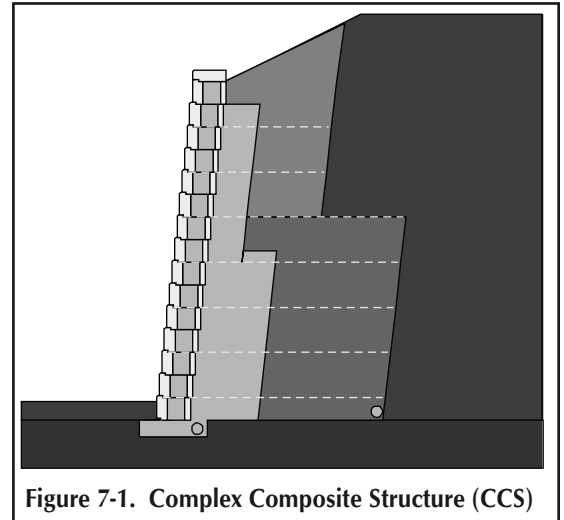

Listed at the end of this chapter are the various wall configuration examples that can be analyzed in AB Walls Design Software as Complex Composite Structures and a set of hand calculations explaining the design process. The design premise will be to design the Upper Structure as a separate wall from the Lower Structure and the Lower Structure as a separate wall with the Upper Structure applied as a surcharge. The complex structures will not be set up to calculate a terraced arrangement. In other words, the facing will be continuously stacked from bottom to top.

The two separate wall calculations will focus on External Stability and to evaluate Internal Compound Stability (ICS) in place of typical internal calculations. The ICS calculations provide a more refined analysis on the internal stresses and resisting forces at multiple slip arc locations. In keeping with the NCMA approach, a design envelope equal to the greater of, twice the height of the total wall structure ($2H$), or the effective height (as determined by the height intersecting the slope at the back of the reinforcement) plus the length of the primary geogrid ($H_e + L$) will be used to define the limits of where the ICS will be conducted. The ICS

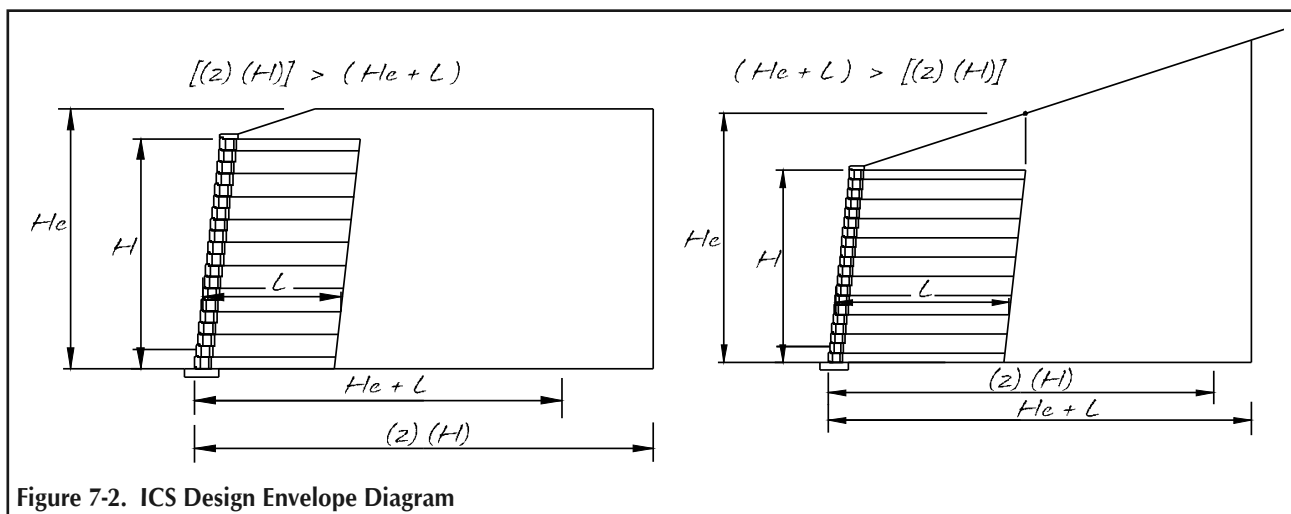

calculations will be run on the total height of the Complex Composite Structure and not specifically on the two elements that make up the CCS. Running ICS for a CCS does not in any way replace the need to have a global analysis conducted to ensure the overall site stability is achieved.

This also provides a future path to evaluating secondary reinforcement, as the concept of secondary reinforcement for facial stability is developed by the industry. Slip arcs used to evaluate internal loads and resisting forces will be constructed using a Modified Bishops approach as used in typical geotechnical slope stability analysis. Contribution from the facing will follow the methods outlined in the Allan Block Engineering Manual and the 3rd Edition NCMA Design Manual which employs shear and connection to quantify these resisting forces.

On any structure where more than one layer of reinforcement is shorter than the lengths of the other reinforcement, at the top of the wall, the CCS method will be utilized. For applications where obstructions occur at the bottom portion of the wall structure we do not recommend shortening the grids at the bottom, but we provide the engineer the ability to use no-fines concrete for the Lower Structure. For a more in depth discussion about no-fines concrete see Appendix D & E. The CCS analysis will provide the engineer the ability to review the suitability of the resisting forces of two different structures, as independent masses, and working together to resist forces that are being applied from the same retained soil mass and all external forces.

The Upper Structure of the CCS will be examined from an External Stability standpoint twice. First the entire top wall will be analyzed by calculating the driving forces, static and dynamic, and comparing it to the resisting forces based on the configuration of the Upper Structure's mass. Additionally, a gravity wall analysis will be run for those unreinforced courses above either the top layer of geogrid or above the no-fines mass when used. For an expanded discussion on this topic see the Top of Wall Stability section at the end of this chapter. This will ensure that localized toppling does not occur. Please remember that the internal analysis is now being conducted using ICS. This which will ensure that the elements that the Upper or Lower Structures are comprised of will hold together as a composite mass.

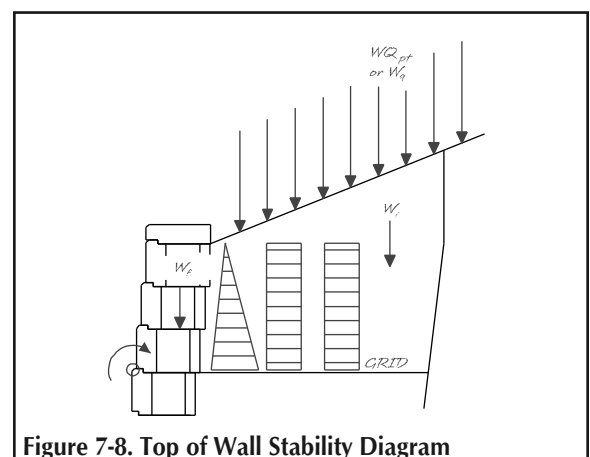
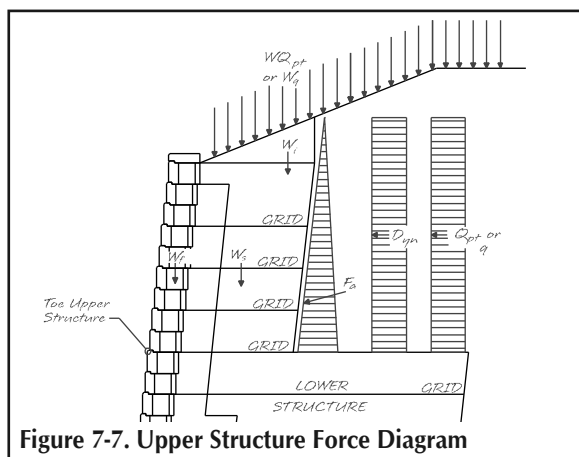
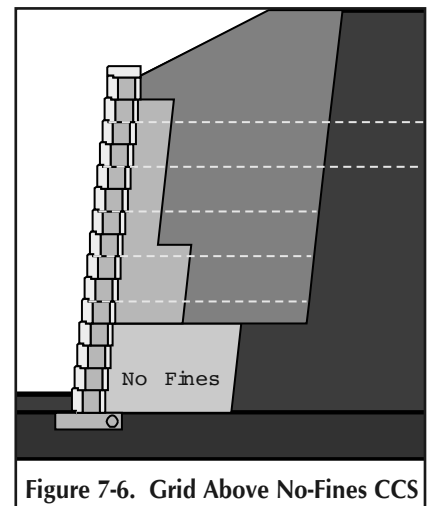
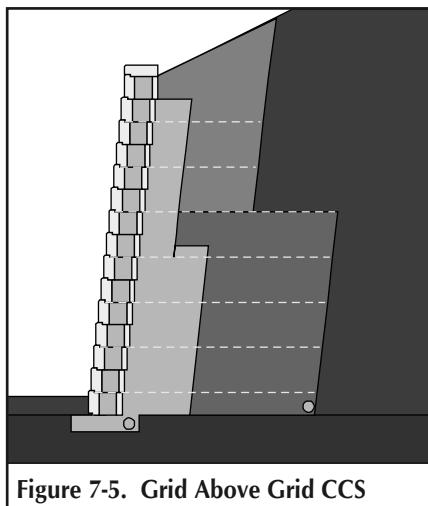
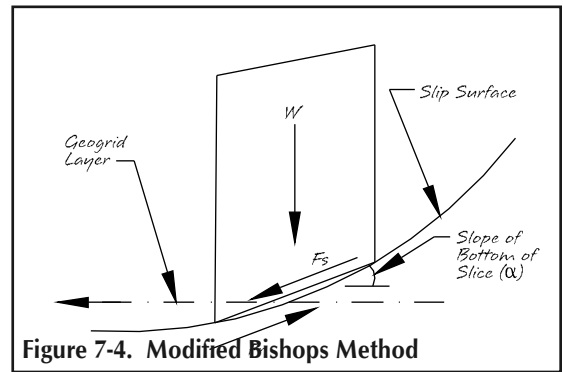
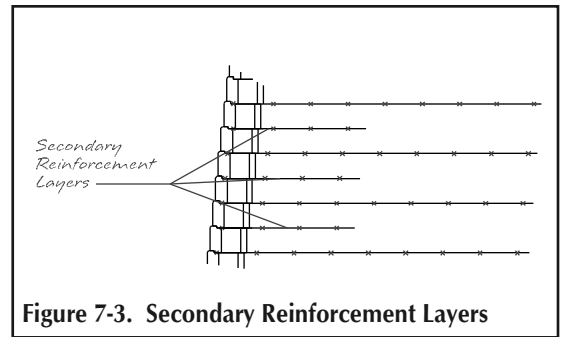

Conducting an External Stability Analysis

There are many combinations for how the project application may require various structural configurations to be designed and assembled to create a CCS. On any given structure there may be three separate External Stability calculations: Lower Structure, Upper Structure, and a gravity wall check above the last layer of reinforcement or above the no-fines mass. The External Stability of the top of wall section and the Upper Structure of a CCS will be calculated as a gravity wall using its own height and depth variables (block, block plus no-fines, block plus geogrid). The Upper Structure can be a reinforced soil structure with shorter geogrid lengths than the Lower Structure, a no-fines concrete mass, a single or double block wall, or a short or long anchoring unit walls. Sliding will be calculated as usual with the addition of the shear lip values at the intersection of the Upper and Lower Structure. The shear capacity is determined through testing (ASTM D6916) and increases linearly based on normal load above the tested course.

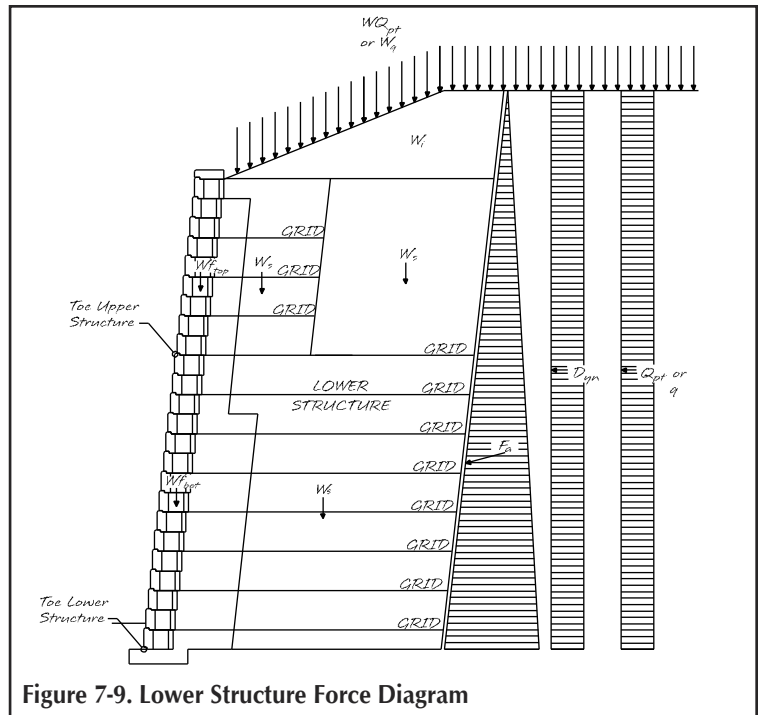

Figure 7-9. Lower Structure Force Diagram

The Lower Structure can be a geogrid reinforced mass (provided that the grid lengths of the Lower Structure are equal to at least 60 percent of the height of the total structure), or a no-fines concrete mass. The Lower Structure will be calculated with the Upper Structure as an applied surcharge. For the overturning calculations, a set of moment arms will be developed to accurately define each possible soil type and weight above as we develop a conservative approach to the more complicated CCS configuration. The active earth pressure will be calculated for the full height of the structure.

External Stability where the Upper Structure extends beyond the Lower Structure

When the Upper Structure extends beyond the depth of the Lower Structure an additional investigation of bearing capacity will be performed on the soil mass behind the lower wall. A limiting ratio of top wall to bottom wall depth of 70% has been implemented based on reviewing outputs and establishing practical limits to a CCS. Therefore if the Upper Structure is 10 ft (3 m) deep measured from the face of the wall to the back limits of the mass, the Lower Structure can be no shorter than 7 ft (2.1 m). These additional calculations are designed to eliminate buckling at the intersection of the Upper and Lower Structure.

The active earth pressure for the Lower Structure will be calculated based on the full height of the total structure, at the back of the deepest structure. To add a level of conservativeness, the moment arms for the active earth pressure for the loading for the Lower Structure will be applied at the back of this shorter lower mass.

Having the Lower Structure shorter in depth to the Upper Structure raises questions about overall wall stability. As mentioned above, the current version of AB Walls will consider soil bearing behind the lower mass. From a bearing standpoint we will use our industry common Meyerhof method, distributed over the bearing width of $L_{width} = SD_{top} - SD_{bottom}$. By calculating all the applied weights and forces we can use the typical Meyerhof equations, see sample calculations at the end of the chapter.

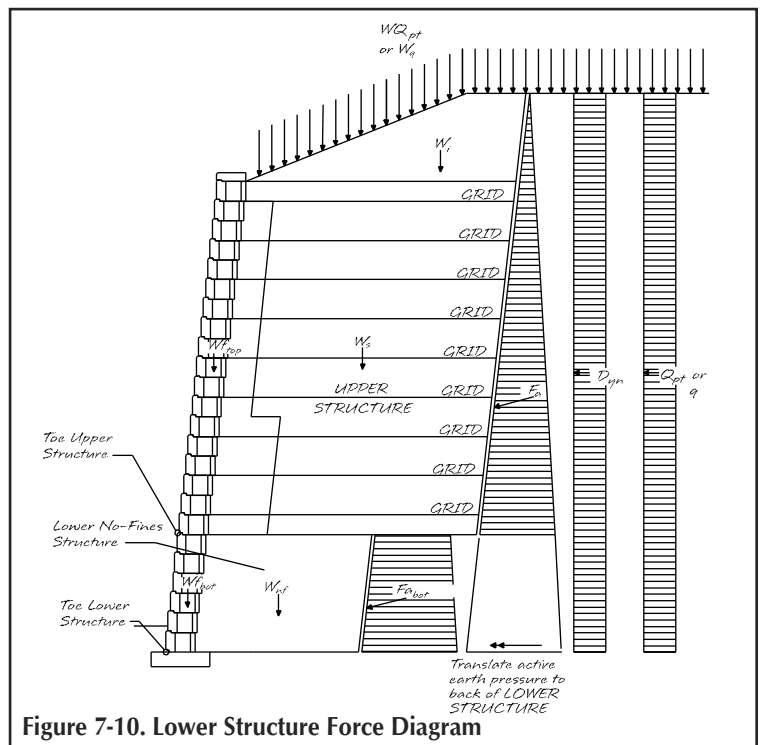

Figure 7-10. Lower Structure Force Diagram

Meyerhof bearing capacity equation: $\sigma_{ult} = (1/2) (\gamma_f) (Lwidth) (N_\gamma) + (c_f) (N_c) + (\gamma_f) (Ldepth + D) (N_q)$

Where:

$$N_q = \exp(\pi \tan \phi_f) \tan^2(45 + \phi_f/2)$$

$$N_c = (N_q - 1) \cot \phi_f$$

$$N_\gamma = (N_q - 1) \tan(1.4\phi_f)$$

Therefore:

$$\sigma_{ult} = (1/2) (\gamma_f) (Lwidth) (N_\gamma) + (c_f) (N_c) + (\gamma_f) (Ldepth + D) (N_q)$$

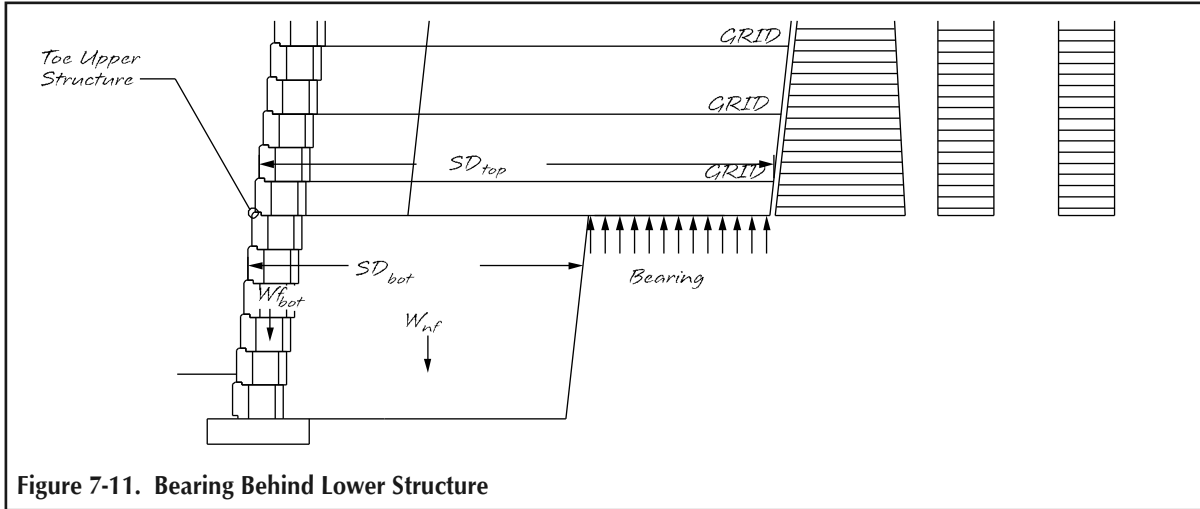

Figure 7-11. Bearing Behind Lower Structure

In this equation, Ldepth is the depth of leveling pad which will be zero in this case since we are not providing one and D is the depth of buried block. One can justify using H_{top} (the height of the top structure) as the depth of buried block, however, Meyerof's equation reacts very favorably to additional buried block therefore we will limit this term to be equal to $1/2 H_{top}$ to be conservative.

Internal Analysis Performed using an Internal Compound Stability (ICS) Analysis

ICS will be run for the total height structure with slip arcs defined by entry nodes above the wall and exit nodes defined by each block course. For a gravity wall, the first entry node is 2 ft behind the face of the top block, whether it is a single or double wall or an AB Fieldstone long or short anchoring unit wall. For a no-fines or geogrid structure, the first entry node is directly up from the back of the mass. The last entry node is always defined at the back of the Design Envelope defined by the greater of $2H$ or $H_e + L$, as discussed earlier. The number of entry points will equal the number of courses of blocks and be divided evenly between the first entry node and the back of the Design Envelope. Please note that when a CCS analysis is triggered the old method of Internal Stability Analysis will be disabled and you will be required to run ICS. AB Walls Design Software and the supporting Mathcad Hand Calculation file provides for the ability to use multiple soil types in both the reinforced mass and the retained soil. With the addition of the CCS analytics you are also able to define a depth of structure with the appropriate properties for these soil types. Being able to specify what type of fill material is being used and exactly where, provides for the full utilization of Internal Compound Stability calculations and allows the engineer to configure the elements of the structure to handle the localized loading. AB Walls Design Software contains a pressure mapping feature that provides a visual illustration of where the lowest factors of safety are, and thereby gives the engineer direct feedback on the critical aspects of their design. These features provide the engineer with a host of options to be able to develop a design, based on the specific challenges that are inherent to their project, that meets the needs of their specific project, is cost effective, and provides the owner with a safe structure. Running ICS for a CCS does not in any way replace the need to have a global analysis conducted to ensure the overall site stability is achieved.

Top of Wall Stability Analysis

The top of every structure needs to be investigated for overturning and sliding stability. This is the gravity portion of the wall that extends above the top layer of geogrid or above the top of the no-fines mass. The depth of this upper gravity wall section can be made up of standard wall units, double block units, or AB Fieldstone units using short or long anchoring units. AB Walls will run a standard overturning and sliding calculations based on all applied forces and resistance based on the facing depth.

AB Walls will take a conservative approach to this overturning calculation. The user has freedom to use double blocks or long anchoring units at any course they choose. Because of this, if the user has not input the same deep block for the entire height of

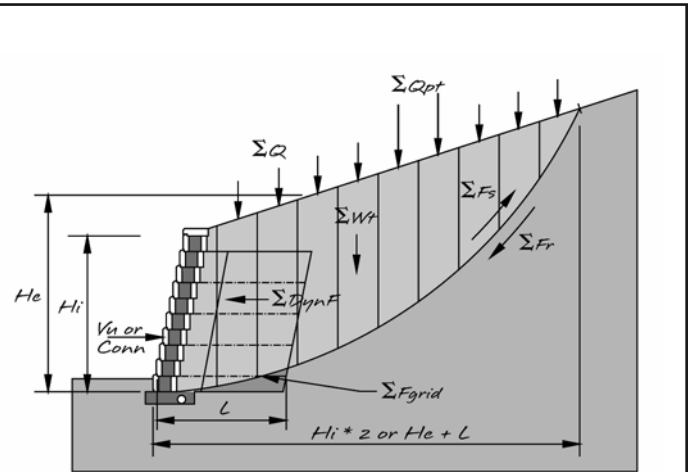

Figure 7-12. ICS Design Envelope & Forces

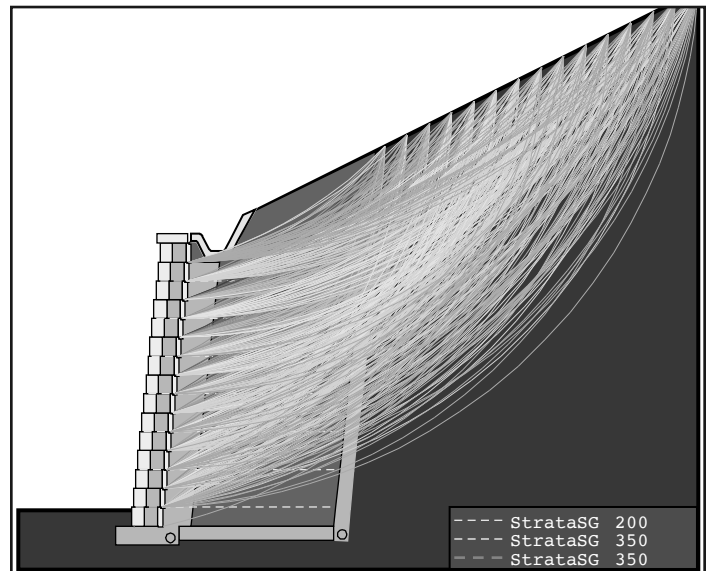

Figure 7-13. ICS Pressure Map Diagram

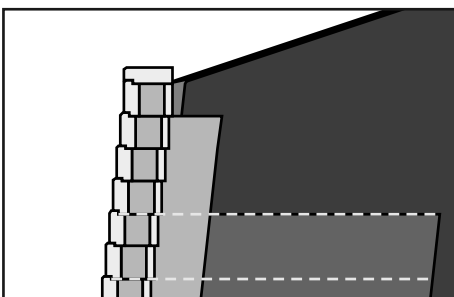

Figure 7-14. Standard Above Wall Config.

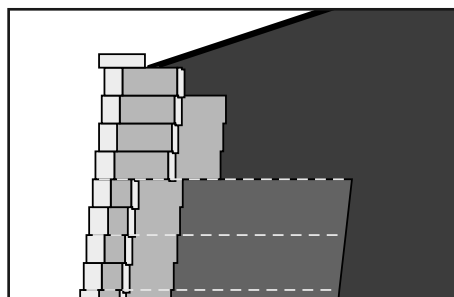

Figure 7-15. Long Anchoring Unit Above

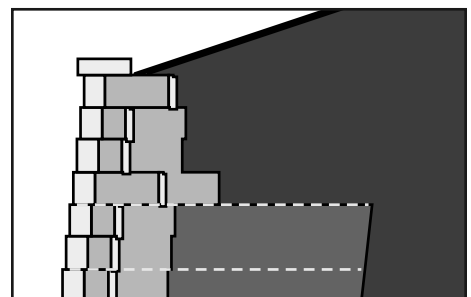

Figure 7-16. Irregular Config. Above

this top portion of their structure, the resisting forces will be based on the single block depth, even if only one block is left short.

It should also be noted that seismic testing conducted in conjunction with Columbia University, (Ling, Lecshinsky et al. 2002), clearly indicated that extending the top layer or layers of reinforcement to 90% of the wall height prevented cracking during high seismic events at the back of the reinforced mass. Based on this testing, and performance in seismically active regions, it is our recommendation that in regions where high pseudo static loading is applied (horizontal acceleration coefficients in excess of 0.20g) that the Upper Structure should not be constructed with a mass depth that is less than 60% of the total wall height and whenever possible, at least one of the top layers of grid should be extended to 90% of the total wall height.

Overview of Design Methods and Tools

The design methods employed utilize the approach and equations contained in other chapters of the Allan Block Engineering Manual and focus them in a manner that is straight forward and consistent with what has been develop over the lifetime of the SRW Industry. In addition to AB Walls, a comprehensive design software for all aspects of technical analysis and creation of construction drawings, the accompanying Mathcad file provides the engineer with the ability to provide hand calculations and, if need be, alter any of the equations to fit their professional judgement for any given project. Contact the Allan Block Engineering Department for assistance or a phone tutorial that also will provide Continuing Education Units (CEU), accredited by IACET, for material covered.

Examples of Complex Composite Structure Configuration in AB Walls

Gravity Wall on Top of Geogrid Wall or No-Fines Wall

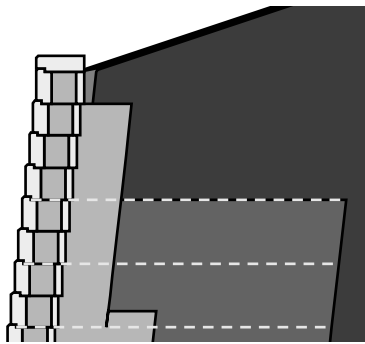

Standard gravity wall above geogrid wall

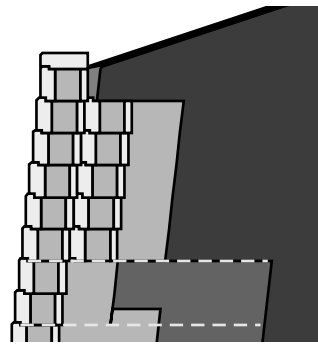

Double block or AB Fieldstone long anchoring unit wall above geogrid wall

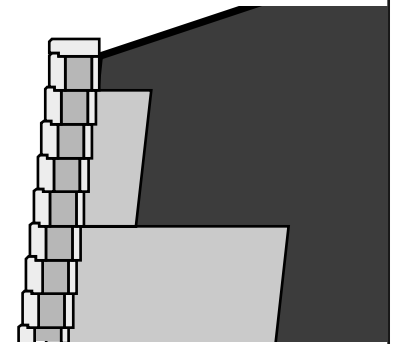

Standard gravity wall above no-fine concrete wall

Geogrid Wall Above or Below

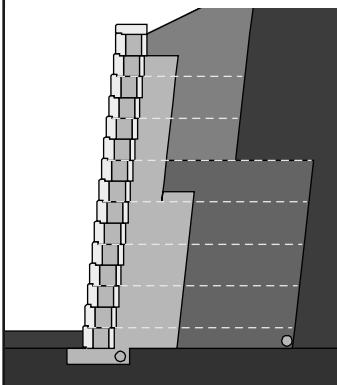

Geogrid lengths in the Upper Structure cannot be less than the standard minimum of 4 ft (120 cm) or 60% of the Upper Structure height

No-Fines on Top or Bottom of a Geogrid Wall Structure

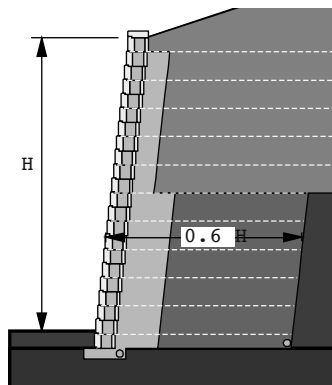

Geogrid lengths in the Lower Structure are recommended to be not less than 60% of the total wall height

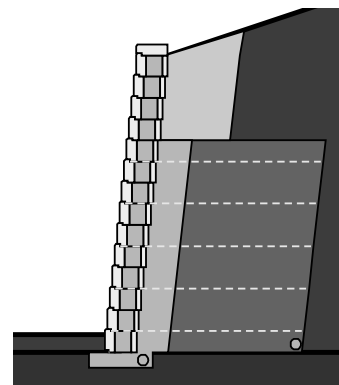

No-fines concrete in the Upper Structure cannot be less than the standard minimum of 2 ft (60 cm) and is commonly designed to be 40% of the Upper Structure height

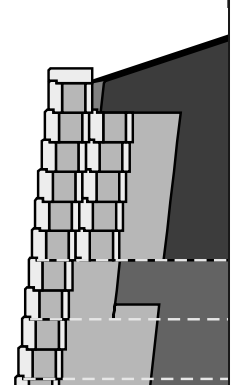

Lower no-fines structure depth cannot be less than 70% of the depth of the Upper Structure

Figure 7-17. Examples of CCS Structures in AB Walls

No-Fines on Top and Bottom with Varied Depth

Although an unlikely scenario, AB Walls allows for varied no-fines depth in CCS structures.

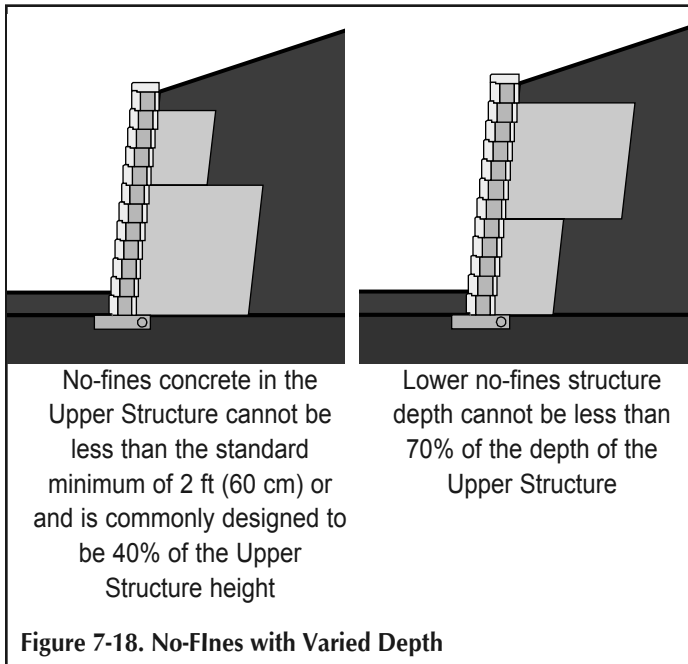

AB Walls Design Software

AB Walls provides a tool to allow the engineer to analyze a Complex Composite Structure with limitations that we have stated in our description of our approach to analyzing this type of configuration. The following provides a review of some limitations that we believe to be judicious when designing a CCS. Some of these apply directly to a Complex Composite Structures, others are what we have found to be Best Practice for all SRW designs.

- We recommend the first layer of grid be placed on top of the first course of block, provide for some flexibility as a result of corners and step ups that may require placement on the second course, but flag designs that have the first course of grid being placed higher than 16 inches (40 cm) from the base.
- We recommend grid spacing at 16 inches (40 cm) maximum but flag designs with more than 24 inches (60 cm) spacing.
- For commercial walls we recommend the minimum length for primary reinforcements to be 4 ft (1.2m). The software does not allow you to reduce this length, but as the engineer you can use the included Mathcad file to adjust as you see fit based on your engineering judgement.
- Although structures have been routinely constructed in a manner similar to what we have covered in this chapter, analysis has not been easily performed. For the purpose of our discussion we have limited the ratio between the Upper and Lower Structures to a ratio of 70% depth of the structure.
- Based on field experience and the advent of a more refined Internal Compound Stability Analysis industry recommendation are that the length of primary reinforcement should not be less than 60% of the total wall height as measured from the face of the block. The CCS approach allows the engineer to achieve a more detailed analysis when dealing with site obstructions.
- The analysis includes an external stability (overturning and sliding for both the Upper and Lower Structure) and factors of safety are reported. The software will not allow for the depth of either structure to be less than what is required to achieve a minimum factor of safety.
- When the Upper Structure is extends beyond the depth of the Lower Structure a bearing analysis is conducted to check for potential rotation and buckling at the intersection of the Upper and Lower Structures. The analysis will check the possible risk of differential settlement that could take place under the Upper Structure due to the unreinforced nature of the soil.

Sample CCS Hand Calculations

Given:

H	=	12 ft	(3.6 m)	L _{grid}	=	7.5 ft	(2.29 m)
H _{top}	=	8 ft	(2.4 m)	L _s	=	0.18 ft	(5.5 cm) (Equivalent lip thickness)
H _{bot}	=	4 ft	(1.2 m)	L _{top}	=	L _{grid} + L _s	= 7.68 ft (2.34 m)
t	=	1 ft	(0.3 m)	γ _{itop}	=	120 lb/ft ³	(1,923 kg/m ³)
φ _{itop}	=	30°		γ _r	=	120 lb/ft ³	(1,923 kg/m ³)
φ _r	=	30°		γ _{nf}	=	110 lb/ft ³	(1,763 kg/m ³)
φ _f	=	30°		γ _{wall_{top}}	=	130 lb/ft ³	(2,061 kg/m ³)
φ _{wr}	=	20°		γ _{wall_{nf}}	=	125 lb/ft ³	(2,002 kg/m ³)
φ _{nf}	=	75°		Structure depth _{NF}	=	5.5 ft	(1.67 m)
ω	=	6°		Sliding coef (CF)	=	tan (φ _f)	
K _{ar}	=	0.254					

This example shows the overturning and sliding calculations for the Lower Structure with the Upper Structure applied as a surcharge. Please note that the overturning and sliding calculations for the Upper Structure will be calculated like any other structure except the upper wall toe will be the top of the lower wall. Therefore this point will become the rotational point for the calculations.

Sliding Calculations

Determine the weight of the structure:

$$\begin{aligned}
 W_{f_{top}} &= (\gamma_{wall_{top}}) (H_{top}) (t) \\
 &= (130 \text{ lb/ft}^3) (8 \text{ ft}) (1 \text{ ft}) = 1,032 \text{ lb/ft} \\
 &= (2,061 \text{ kg/m}^3) (2.4 \text{ m}) (0.3 \text{ m}) (9.81 \text{ m/sec}^2) = 14,557 \text{ N/m}
 \end{aligned}$$

$$\begin{aligned}
 W_{f_{bot}} &= (\gamma_{wall_{bot}}) (H_{bot}) (t) \\
 &= (125 \text{ lb/ft}^3) (4 \text{ ft}) (1 \text{ ft}) = 500 \text{ lb/ft} \\
 &= (2,002 \text{ kg/m}^3) (1.2 \text{ m}) (0.3 \text{ m}) (9.81 \text{ m/sec}^2) = 7,070 \text{ N/m}
 \end{aligned}$$

$$\begin{aligned}
 W_{s_{top}} &= (\gamma_{itop}) (H_{top}) (L_{top} - t) \\
 &= (120 \text{ lb/ft}^3) (8 \text{ ft}) (7.68 \text{ ft} - 1 \text{ ft}) = 6,413 \text{ lb/ft} \\
 &= (1,923 \text{ kg/m}^3) (2.4 \text{ m}) (2.34 \text{ m} - 0.3 \text{ m}) (9.81 \text{ m/sec}^2) = 92,361 \text{ N/m}
 \end{aligned}$$

$$\begin{aligned}
 W_{nf} &= (\gamma_{nf}) (H_{bot}) (\text{Structure depth}_{NF} - t) \\
 &= (110 \text{ lb/ft}^3) (4 \text{ ft}) (5.5 \text{ ft} - 1 \text{ ft}) = 1,980 \text{ lb/ft} \\
 &= (1,763 \text{ kg/m}^3) (1.2 \text{ m}) (1.67 \text{ m} - 0.3 \text{ m}) (9.81 \text{ m/sec}^2) = 28,433 \text{ N/m}
 \end{aligned}$$

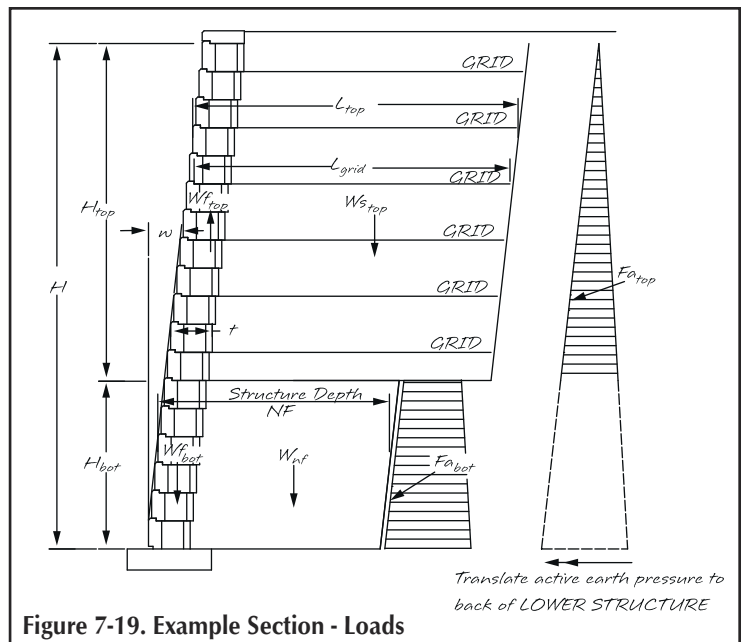

Figure 7-19. Example Section - Loads

Upper wall forces:

$$\begin{aligned}F_{a_{top}} &= (0.5) (\gamma_r) (K_{ar}) (H_{top})^2 \\ &= (0.5) (120 \text{ lb/ft}^3) (0.254) (8 \text{ ft})^2 = 975 \text{ lb/ft} \\ &= (0.5) (1,923 \text{ kg/m}^3) (0.254) (2.4 \text{ m})^2 (9.81 \text{ m/sec}^2) = 13,800 \text{ N/m}\end{aligned}$$

$$\begin{aligned}F_{ah_{top}} &= F_{a_{top}} (\cos \phi_{wr}) \\ &= 975 \text{ lb/ft} (\cos 20^\circ) = 916 \text{ lb/ft} \quad = 13,800 \text{ N/m} (\cos 20^\circ) = 12,968 \text{ N/m}\end{aligned}$$

$$\begin{aligned}F_{av_{top}} &= F_{a_{top}} (\sin \phi_{wr}) \\ &= 975 \text{ lb/ft} (\sin 20^\circ) = 333 \text{ lb/ft} \quad = 13,800 \text{ N/m} (\sin 20^\circ) = 4,720 \text{ N/m}\end{aligned}$$

Lower wall forces:

$$\begin{aligned}F_{a_{bot}} &= (0.5) (\gamma_r) (K_{ar}) (H)^2 - F_{a_{top}} \\ &= (0.5) (120 \text{ lb/ft}^3) (0.254) (12 \text{ ft})^2 - 975 \text{ lb/ft} = 1,220 \text{ lb/ft} \\ &= (0.5) (1,923 \text{ kg/m}^3) (0.254) (3.6 \text{ m})^2 (9.81 \text{ m/sec}^2) - (13,800 \text{ N/m}) = 17,250 \text{ N/m}\end{aligned}$$

$$\begin{aligned}F_{ah_{bot}} &= F_{a_{bot}} (\cos \phi_{wr}) \\ &= 1,220 \text{ lb/ft} (\cos 20^\circ) = 1,146 \text{ lb/ft} \quad = 17,250 \text{ N/m} (\cos 20^\circ) = 16,210 \text{ N/m}\end{aligned}$$

$$\begin{aligned}F_{av_{bot}} &= F_{a_{bot}} (\sin \phi_{wr}) \\ &= 1,220 \text{ lb/ft} (\sin 20^\circ) = 417 \text{ lb/ft} \quad = 17,250 \text{ N/m} (\sin 20^\circ) = 5,900 \text{ N/m}\end{aligned}$$

Total Horizontal Force:

$$\begin{aligned}F_h &= F_{ah_{top}} + F_{ah_{bot}} \\ &= 916 \text{ lb/ft} + 1,146 \text{ lb/ft} = 2,062 \text{ lb/ft} \quad = 12,968 \text{ N/m} + 16,210 \text{ N/m} = 29,178 \text{ N/m}\end{aligned}$$

Total Vertical Force:

$$\begin{aligned}V_t &= W_{f_{top}} + W_{f_{bot}} + W_{s_{top}} + W_{nf} + F_{av_{top}} + F_{av_{bot}} \\ &= 1,032 \text{ lb/ft} + 500 \text{ lb/ft} + 6,413 \text{ lb/ft} + 1,980 \text{ lb/ft} + 333 \text{ lb/ft} + 417 \text{ lb/ft} = 10,675 \text{ lb/ft} \\ &= 14,557 \text{ N/m} + 7,070 \text{ N/m} + 92,361 \text{ N/m} + 28,433 \text{ N/m} + 4,720 \text{ N/m} + 5,900 \text{ N/m} = 147,849 \text{ N/m}\end{aligned}$$

Sliding Force:

$$\begin{aligned}F_r &= V_t (C_f) \\ &= 10,675 \text{ lb/ft} [\tan (30^\circ)] = 6,163 \text{ lb/ft} \quad = 147,849 \text{ N/m} [\tan (30^\circ)] = 85,361 \text{ N/m}\end{aligned}$$

The Safety Factor against Sliding:

$$\begin{aligned}\text{SFS} &= F_r / F_h \\ &= 6,163 \text{ lb/ft} / 2,062 \text{ lb/ft} = 2.98 \quad = 85,361 \text{ N/m} / 29,178 \text{ N/m} = 2.98\end{aligned}$$

Overturing Calculations

We will first start by determining the moment arms for each force.

$$\begin{aligned}
 Wf_{topArm} &= 0.5t + (0.5H_{top} + H_{bot}) \tan(\omega) \\
 &= (0.5)(1.0 \text{ ft}) + (0.5)(8 \text{ ft} + 4 \text{ ft}) \\
 &\quad \tan(6.4^\circ) = 1.4 \text{ ft} \\
 &= (0.5)(0.3 \text{ m}) + (0.5)(2.4 \text{ m} + 1.2 \text{ m}) \\
 &\quad \tan(6.4^\circ) = 0.43 \text{ m}
 \end{aligned}$$

$$\begin{aligned}
 Wf_{botArm} &= 0.5t + 0.5(H_{bot}) \tan(\omega) \\
 &= (0.5)(1 \text{ ft} + 0.5(4 \text{ ft}) \tan(6.4^\circ) \\
 &= 0.73 \text{ ft} \\
 &= (0.5)(0.3 \text{ m} + 0.5(1.2 \text{ m}) \tan(6.4^\circ) \\
 &= 0.22 \text{ m}
 \end{aligned}$$

$$\begin{aligned}
 Ws_{topArm} &= (0.5H_{top} + H_{bot}) \tan(\omega) + t \\
 &\quad + 0.5(L_{grid} - t) \\
 &= (0.5)(8 \text{ ft} + 4 \text{ ft}) \tan(6.4^\circ) + 1 \text{ ft} + 0.5(7.68 \text{ ft} - 1 \text{ ft}) = 5.23 \text{ ft} \\
 &= (0.5)(2.4 \text{ m} + 1.2 \text{ m}) \tan(6.4^\circ) + 0.3 \text{ m} + 0.5(2.34 \text{ m} - 0.3 \text{ m}) = 1.6 \text{ m}
 \end{aligned}$$

$$\begin{aligned}
 Wnf_{Arm} &= 0.5(H_{bot}) \tan(\omega) + t + 0.5(\text{Structure depth}_{NF} - t) \\
 &= 0.5(4 \text{ ft}) \tan(6.4^\circ) + 1 \text{ ft} + 0.5(5.5 \text{ ft} - 1 \text{ ft}) = 3.48 \text{ ft} \\
 &= 0.5(1.2 \text{ m}) \tan(6.4^\circ) + 0.3 \text{ m} + 0.5(1.67 \text{ m} - 0.3 \text{ m}) = 1.06 \text{ m}
 \end{aligned}$$

$$\begin{aligned}
 Fah_{topArm} &= H_{bot} + 0.33(H_{top}) \\
 &= 4 \text{ ft} + 0.33(8 \text{ ft}) = 6.67 \text{ ft} \\
 &= 1.2 \text{ m} + 0.33(2.4 \text{ m}) = 2.03 \text{ m}
 \end{aligned}$$

$$\begin{aligned}
 Fav_{topArm} &= L_{top} + [0.33(H_{top}) + H_{bot}] \tan(\omega) \\
 &= 8 \text{ ft} + [0.33(8 \text{ ft}) + 4 \text{ ft}] \tan(6.4^\circ) = 8.4 \text{ ft} \\
 &= 2.4 \text{ m} + [0.33(2.4 \text{ m}) + 1.2 \text{ m}] \tan(6.4^\circ) = 2.57 \text{ m}
 \end{aligned}$$

Due to the translation of the bottom force trapezoid we need to find the vertical centroid.

$$\begin{aligned}
 Fah_{botArm} &= (H_{bot}/3) [H + (2)(H_{top})] / (H + H_{top}) \\
 &= (4 \text{ ft}/3) [12 \text{ ft} + (2)(8 \text{ ft})] / (12 \text{ ft} + 8 \text{ ft}) = 1.87 \text{ ft} \\
 &= (1.2 \text{ m}/3) [3.6 \text{ m} + (2)(2.4 \text{ m})] / (3.6 \text{ m} + 2.4 \text{ m}) = 0.57 \text{ m}
 \end{aligned}$$

$$\begin{aligned}
 Fav_{botArm} &= \text{Structure depth}_{NF} + (Fah_{botArm}) \tan(\omega) \\
 &= 5.5 \text{ ft} + (1.87 \text{ ft}) \tan(6.4^\circ) = 5.7 \text{ ft} \\
 &= 1.67 \text{ m} + (0.57 \text{ m}) \tan(6.4^\circ) = 1.74 \text{ m}
 \end{aligned}$$

Total Resisting Moment:

$$\begin{aligned}
 \Sigma Mr &= (Wf_{top})(Wf_{topArm}) + (Wf_{bot})(Wf_{botArm}) + (Ws_{top})(Ws_{topArm}) \\
 &\quad + (Wnf)(Wnf_{Arm}) + (Fav_{top})(Fav_{topArm}) + (Fav_{bot})(Fav_{botArm}) \\
 &= (1,032 \text{ lb/ft})(1.4 \text{ ft}) + (500 \text{ lb/ft})(0.73 \text{ ft}) + (6,413 \text{ lb/ft})(5.23 \text{ ft}) \\
 &\quad + (1,980 \text{ lb/ft})(3.48 \text{ ft}) + (333 \text{ lb/ft})(8.4 \text{ ft}) + (417 \text{ lb/ft})(5.7 \text{ ft}) = 47,414 \text{ ft-lb/ft} \\
 &= (14,557 \text{ N/m})(0.43 \text{ m}) + (7,070 \text{ N/m})(0.22 \text{ m}) + (92,361 \text{ N/m})(1.6 \text{ m}) \\
 &\quad + (28,433 \text{ N/m})(1.06 \text{ m}) + (4,720 \text{ N/m})(2.5 \text{ m}) + (5,900 \text{ N/m})(1.74 \text{ m}) = 211,408 \text{ N-m/m}
 \end{aligned}$$

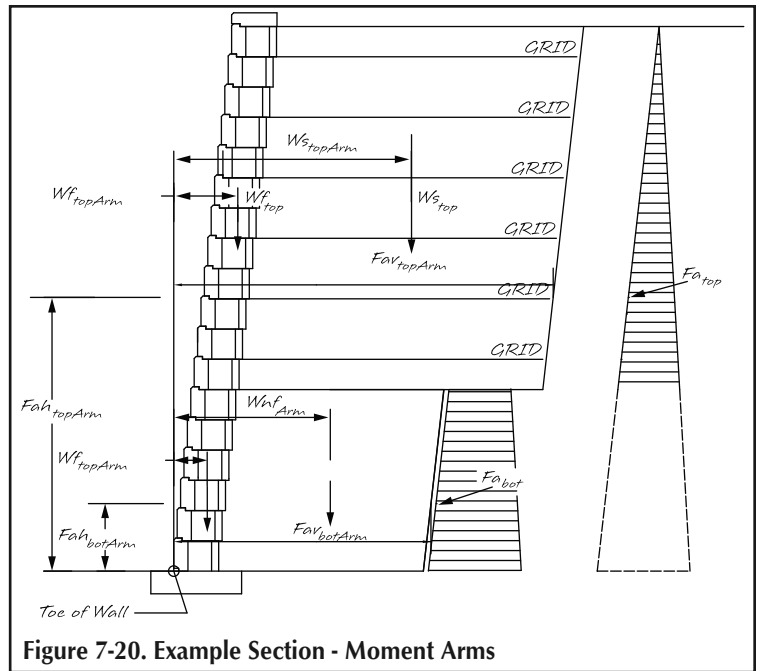

Figure 7-20. Example Section - Moment Arms

Total Overturning Moment:

$$\begin{aligned} \Sigma M_o &= (F_{ah_top}) (F_{ah_topArm}) + (F_{ah_bot}) (F_{ah_botArm}) \\ &= (916 \text{ lb/ft}) (6.67 \text{ ft}) + (1,146 \text{ lb/ft}) (1.87 \text{ ft}) = 8,250 \text{ lb-ft/ft} \\ &= (12,968 \text{ N/m}) (2.03 \text{ m}) + (16,210 \text{ N/m}) (0.57 \text{ m}) = 36,704 \text{ N-m/m} \end{aligned}$$

The Safety Factor against Overturning:

$$\begin{aligned} SFOS &= S_{Mr} / S_{Mo} \\ &= 47,414 \text{ ft-lb/ft} / 8,250 \text{ lb-ft/ft} = 5.76 \\ &= 211,408 \text{ N-m/m} / 36,704 \text{ N-m/m} = 5.76 \end{aligned}$$

The Pressure Map for this example from AB Walls shows all results well above the minimum of 1.3 and as expected the worst case arcs come in directly above the no-fines concrete mass.

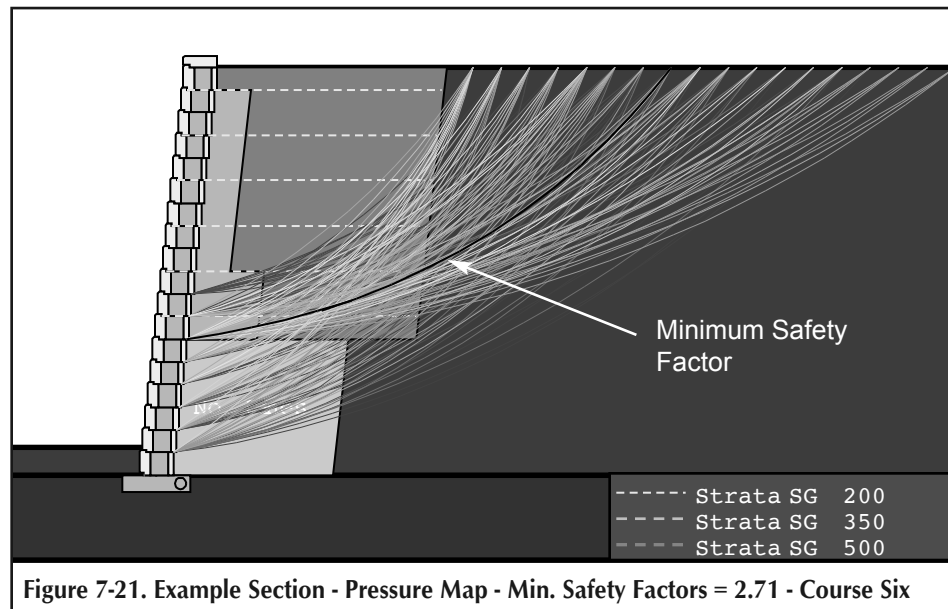

Bearing Capacity Calculations

Bearing safety factors are very straight forward by determining the downward vertical force and comparing them to the bearing capacity of the site soils. Allan Block also calculates the forward rotational forces and if they are positive, they are added to the bearing forces.

The first step is to determine the eccentricity of the structure.

Determine the vertical resisting forces:

$$\begin{aligned} R_{m_o} &= W_{f_top} + W_{f_bot} + W_{s_top} \\ &+ W_{nf} + F_{av_top} + F_{av_bot} \\ &= 1,032 \text{ lb/ft} + 500 \text{ lb/ft} + 6,413 \text{ lb/ft} \\ &+ 1,980 \text{ lb/ft} + 333 \text{ lb/ft} + 417 \text{ lb/ft} \\ &= 10,675 \text{ lb/ft} \\ &= 14,557 \text{ N/m} + 7,070 \text{ N/m} + 92,361 \text{ N/m} \\ &+ 28,433 \text{ N/m} + 4,720 \text{ N/m} + 5,900 \text{ N/m} \\ &= 147,849 \text{ N/m} \end{aligned}$$

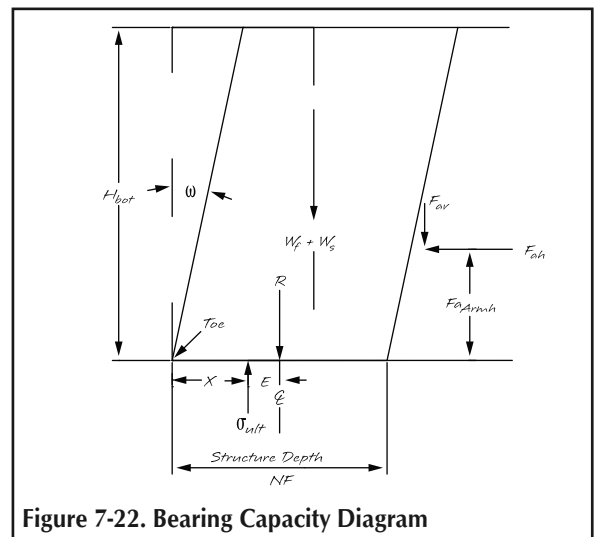

Determine the Positive rotational forces:

$$\begin{aligned}
 \text{Positive} &= (W_{f_{\text{top}}}) (W_{f_{\text{topArm}}}) + (W_{f_{\text{bot}}}) (W_{f_{\text{botArm}}}) + (W_{s_{\text{top}}}) (W_{s_{\text{topArm}}}) \\
 &+ (W_{nf}) (W_{nf_{\text{Arm}}}) + (F_{av_{\text{top}}}) (F_{av_{\text{topArm}}}) + (F_{av_{\text{bot}}}) (F_{av_{\text{botArm}}}) \\
 &= (1,032 \text{ lb/ft}) (1.4 \text{ ft}) + (500 \text{ lb/ft}) (0.73 \text{ ft}) + (6,413 \text{ lb/ft}) (5.23 \text{ ft}) \\
 &+ (1,980 \text{ lb/ft}) (3.48 \text{ ft}) + (333 \text{ lb/ft}) (8.4 \text{ ft}) + (417 \text{ lb/ft}) (5.7 \text{ ft}) = 47,414 \text{ ft-lb/ft} \\
 &= (14,557 \text{ N/m}) (0.43 \text{ m}) + (7,070 \text{ N/m}) (0.22 \text{ m}) + (92,361 \text{ N/m}) (1.6 \text{ m}) \\
 &+ (28,433 \text{ N/m}) (1.06 \text{ m}) + (4,720 \text{ N/m}) (2.5 \text{ m}) + (5,900 \text{ N/m}) (1.74 \text{ m}) = 211,408 \text{ N-m/m}
 \end{aligned}$$

Determine the Negative rotational forces:

$$\begin{aligned}
 \text{Negative} &= (F_{ah_{\text{top}}}) (F_{ah_{\text{topArm}}}) + (F_{ah_{\text{bot}}}) (F_{ah_{\text{botArm}}}) \\
 &= (916 \text{ lb/ft}) (6.67 \text{ ft}) + (1,146 \text{ lb/ft}) (1.87 \text{ ft}) = 8,250 \text{ lb-ft/ft} \\
 &= (12,968 \text{ N/m}) (2.03 \text{ m}) + (16,210 \text{ N/m}) (0.57 \text{ m}) = 36,704 \text{ N-m/m}
 \end{aligned}$$

$$X = (\text{Positive} - \text{Negative}) / Rm_O = 3.67 \text{ ft} \quad 1.1 \text{ m}$$

Determine the eccentricity, E, of the resultant vertical force. If the eccentricity is negative the maximum bearing pressure occurs at the heel of the mass. Therefore, a negative eccentricity causes a decrease in pressure at the toe. For conservative calculations E will always be considered greater than or equal to zero.

$$E = 0.5(\text{Structure depth}_{NF}) - X = -0.93 \text{ ft} \quad -0.3 \text{ m}$$

* Since E is negative there is no additional rotational force.

Determine the average bearing pressure acting at the centerline of the wall:

$$\sigma_{\text{avg}} = Rm_O / (\text{Structure depth}_{NF}) = 1,942 \text{ lb/ft}^2 \quad 93 \text{ kPa}$$

Use Meyerhof bearing capacity equations to determine the ultimate capacity based on site and soil conditions.

Meyerhof bearing capacity equation:

$$\sigma_{\text{ult}} = (1/2) (\gamma_f) (L_{\text{width}}) (N_\gamma) + (c_f) (N_c) + (\gamma_f) (L_{\text{depth}} + D) (N_q)$$

Where:

$$N_q = \exp(\pi \tan \phi_f) \tan^2(45 + \phi_f/2)$$

$$N_c = (N_q - 1) \cot \phi_f$$

$$N_\gamma = (N_q - 1) \tan(1.4\phi_f)$$

Therefore:

$$\begin{aligned}
 \sigma_{\text{ult}} &= (1/2) (\gamma_f) (L_{\text{width}}) (N_\gamma) + (c_f) (N_c) + (\gamma_f) (L_{\text{depth}} + D) (N_q) \\
 &= 4,456 \text{ lb/ft}^2 \quad 213 \text{ kPa}
 \end{aligned}$$

$$SF_{\text{bearing}} = \frac{\sigma_{\text{ult}}}{\sigma_{\text{avg}}} = 2.3$$

SF_{bearing} is greater than the required minimum of 2.0 therefore bearing is adequate.

Chapter Eight

Limit Equilibrium Method (LEM)

Introduction

Limit Equilibrium (LE) is not a new term but it is new to the Segmental Retaining Wall (SRW) design practice. LE is a way to describe the process of determining the global stability of a slope or wall structure. Since the inclusion of Internal Compound Stability (ICS) into the SRW design process in 2007, the entire SRW industry has looked at the inclusion of a global stability “Like” analysis as clearly the more accurate approach to determine the internal stability of a geogrid reinforced wall or even a simple gravity wall. A complete discussion of ICS can be found in Chapter Six of this manual. The Limit Equilibrium Method (LEM) has been developed by University Professor Dov Leshchinsky, PH.D. through years of research and was recently adopted by the Federal Highways Administration National Geotechnical Team (FHWA), the National Concrete Masonry Association (NCMA), and American Association of State Highway Transportation Officials (AASHTO) as a viable alternative for traditional SRW Internal design calculations. The main goal of LEM is to expand on the ICS model and bring an even higher level of global stability analysis into the internal design process. The FHWA published manual (FHWA –HIF-17-004) is available for download at the FHWA Office of Bridges and Structures website.

By adopting LEM, the industry is abandoning the old, more theoretical Coulomb pressure calculations for this easy to understand and highly accurate global modeling method. LEM uses a Simplified Method of Slices - Bishop’s model - to determine the forward forces that need to be resisted by the geogrid layers and facing material. The forward forces are determined simply by subtracting the Resisting Forces (F_r) along a slip arc from the Sliding forces (F_s) along that same slip arc (Figure 8-1). If the resulting forces are positive, there are sliding forces that need to be accounted for by geogrid layers. These forces will be discussed later as we define the required resisting forces within a grid layer (T_{req}). Likewise, if the resulting forces are negative, the slip arc has no sliding forces and thus the slip arc is stable without geogrid interaction.

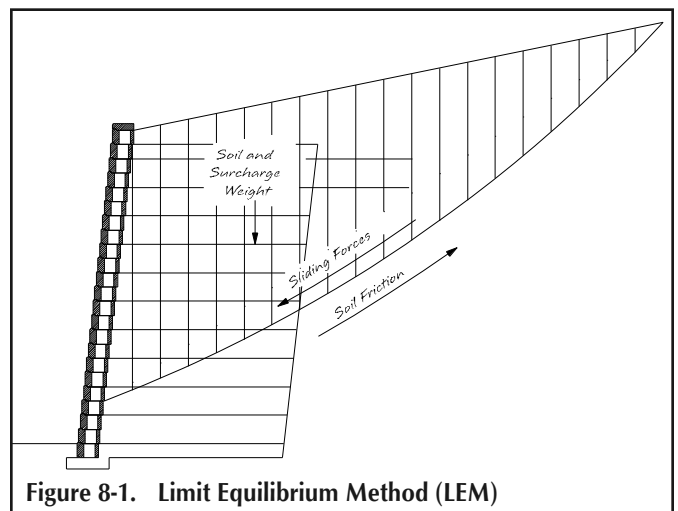

We as an industry know so much more about SRWs than we did when they were first introduced in the early 1980's. We now know there should be minimum things to consider regardless of design method when starting a design. That is, minimum suggested grid lengths should still be at least 60% of the total wall height and that closer grid spacing develops higher levels of system performance. Recommendations limit grid spacing to 16 inches (40 cm) unless the structures are less than ten feet (3 m) and the structures are constructed with all structural material in the reinforced zone. In practice, grid spacing should never be greater than 24 inches (60 cm). With this said, Columbia University and University of Delaware researchers conducted full-scale seismic testing on segmental walls using Allan Block facing units under various seismic loading conditions. The results were extremely good and although there were many specific recommendations that came from this testing for all types of SRW products, the most important one was the positive results of closer grid spacing. Therefore, this discussion and later design example will use these recommended minimums as a starting place for design.

Lastly, one of the major positives for LEM is its flexibility of global modeling. This method allows for a similar design approach for all types of wall and sloped structures including standard single wall applications, terraced wall applications, water applications, static and seismic applications, etc. Basically, any wall application that can be modeled in global can be modeled in LEM.

LEM Design Method as compared to ICS

The Simplified Bishop Method of Slices is one of the most popular global design methods used today and for that reason is used as the base method for determining the forward sliding forces in the new LEM and the current ICS method discussed earlier in Chapter 6. Although LEM is very similar in many ways to ICS, there are three major differences between them. First, the design slip arcs will enter the wall system very close to the back of the cap unit as opposed to in ICS where the first arcs started at the back of the geogrid mass (Figure 8-2).

This may sound trivial but the reason behind this is that the first arcs can run down through the mass directly behind the facing allowing for a more complete coverage of slip surfaces from the back of the facing and well back into the retained soils. The ultimate goal is to calculate the required tensile force (T_{req}) along each grid layer from the back of the facing to the end of each layer of grid. This is not possible using the ICS

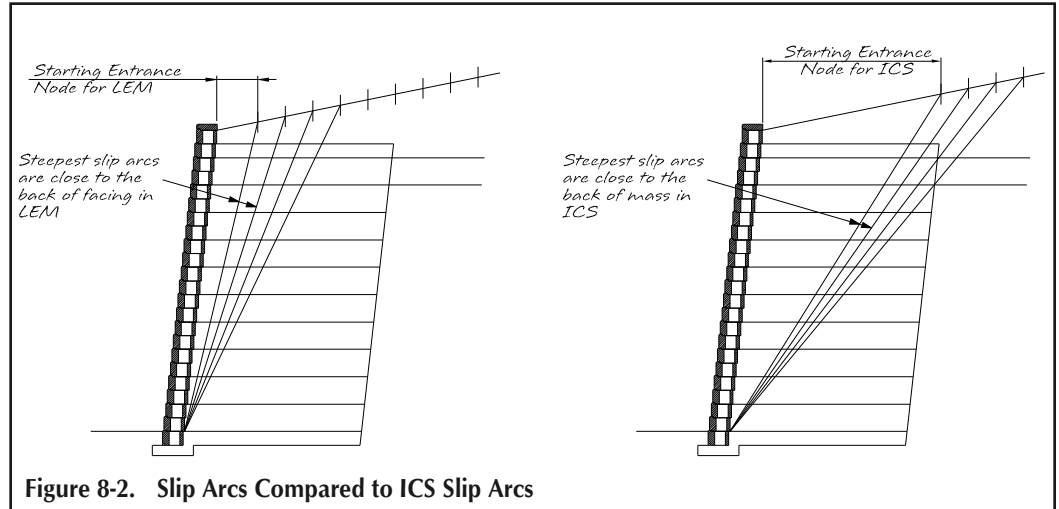

Figure 8-2. Slip Arcs Compared to ICS Slip Arcs

starting entrance point. The second major difference is we are using the Bishops modeling to determine the sliding and resisting force within the soils alone. We do this by forcing the calculations to run with a safety factor of 1.0, or in other words, at equilibrium. By simplifying the process down to equilibrium (1.0), we can isolate exactly how much force (T_{req}) has to be transferred into the geogrid layer's strength and soil pullout capacity and facing connection and facing shear. The traditional Bishops method uses an iterative process to determine the global safety factor along a particular slip surface using soil friction, geogrid strength, and pullout of soil capacity of the geogrid. This iterative process is difficult and requires many more calculations to determine the actual safety factor. By using the 1.0 safety factor, the Bishop calculation no longer requires the iteration process and simply returns the resulting forward forces. Also, traditional global programs ignore any facing contribution like connection and shear because they do not have the ability to utilize them. LEM and ICS do not ignore the facing as it is a critical part of the composite mass. Current methodologies, not based on a Bishops type analysis, oversimplify and incorrectly overestimate loads at the face of the structure and identify much higher loads at the block facing that must be dealt with in the design process. This has resulted in designs that put too much emphasis on connection loads and not enough attention on enhancing the reinforced mass through the introduction of more reinforcement to compliment the load carrying capabilities of the compacted soil mass. Therefore, once Bishops calculates the T_{req} for each slip arc, that value is then divided equally between each grid layer the slip arc comes in contact with. This even distribution assumes that all contacted layers share the load equally and thus fail simultaneously. This will be discussed in depth below. Now with the overall T_{req} divided to each grid layer along each slip arc, the T_{req} is now known for any location along any one of the individual grid layers. It is now easy to determine the maximum T_{req} or T_{max} for each grid layer, (Figure 8-3).

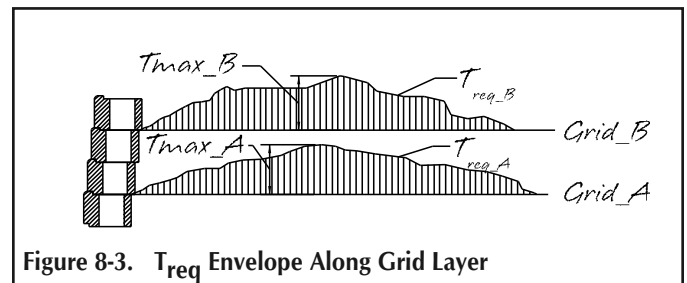

Figure 8-3. T_{req} Envelope Along Grid Layer

Once we have T_{max} for each grid layer an appropriate safety factor, such as our commonly used 1.5, can be applied and the designer can select a geogrid with an LTADS that exceeds this value.

The third difference is how the facing contribution is determined. ICS uses the tested connection capacity using the results from ASTM D 6686 directly in the Safety factor equation and thus using it in the iterative process. LEM, as you will see in a later section, will utilize the T_{req} in the front end of the grid to determine the minimum required connection resistance T_0 providing a similarity in design and modeling approach.

Bishop's Approach to determine forward sliding forces (Part I of the LEM Analysis)

A computer modeling program such as AB Walls can do thousands of calculations a second, thus making the analysis of thousands of slip surfaces possible. The Bishop's model works for this reason. For a LEM Bishop's Model to be as accurate as possible, a methodical approach of creating enough slip arcs to produce a virtually continuous interaction along the length of each grid layer is necessary, as seen in Figure 8-3. Therefore, like ICS, each block course will represent an exit node. Like ICS, there will be no slip arcs allowed to exit below the top of the leveling pad. LEM is not meant to replace the need for external stability and a complete global stability analysis, but rather provides a more refined and precise evaluation of the internal forces in the reinforced mass. Each slip arc will be determined by first forming a straight-line cord between every entrance and every exit node. Each cord is then made into a slip arc by adding a radius, arcing between the entrance and exit nodes. By calculating 20 or more radius points through the same two entrance and exit nodes, the model will produce results covering virtually 100% of the possible interaction locations along each grid layer when combined with all the other cord combinations, see Figure 8-4. This is an important concept to grasp to fully understand how a global model works; you need complete coverage to create an accurate model. By using only one or two entrance and exit node combinations or one of two radius points to form the slip arcs, the model would potentially be incomplete leaving gaps in the analysis.

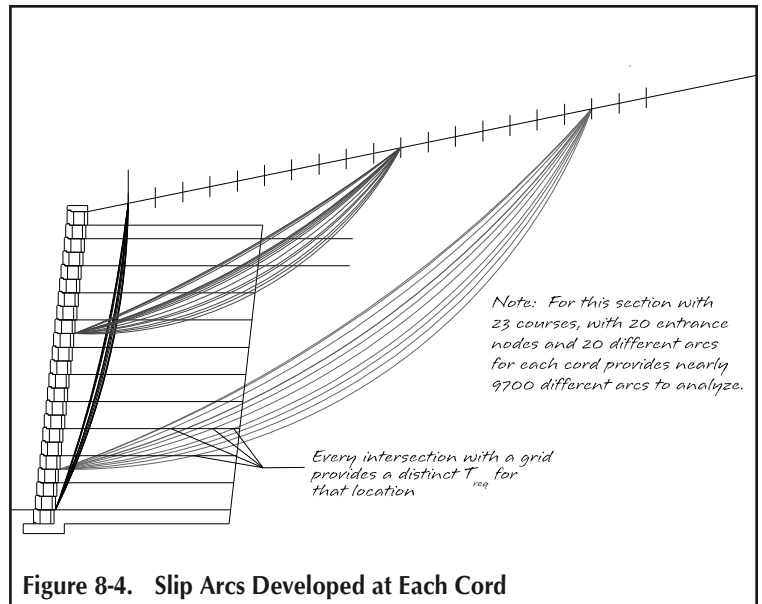

Figure 8-4. Slip Arcs Developed at Each Cord

Soil Sliding and Resisting forces

The Simplified Bishop Method of Slices is used to determine first the weight of the soil above the slip surface and then the sliding and resisting forces due to that soil weight along the slip surface. The vertical slices in the soil above the slip arc represent the individual portions of soil analyzed using Bishop's theory. We will determine the weights and forces relative to one soil slice as an example. For a complete Simplified Bishop Method of Slices the designer would follow the same calculations for each individual soil slice and at the end, sum them all together. In Bishop modeling, the soil slices can be calculated as individual parts due mainly to Bishop's assumption that the vertical frictional forces between soil slices are neglected, meaning that for design purposes there is no interaction between individual soil slices. Therefore, the individual soil slice weight (W_j) is determined simply by multiplying the volume of soil in that slice by the unit weight of the soil. To determine the individual slice volumes the designer must determine the exact geometry of the wall section and the slip arc to be evaluated. For each slip arc there is an x and y coordinate for the entrance node and for the exit node. To determine the common width of each slice, simply determine the horizontal distance between the entrance and exit node and divide by the number of desired slices. Please note that the thinner the slice is the more accurate the weight calculations will be. For ease of calculations the bottom of each slice is assumed to be a straight cord and not the curved slip arc, see Figure 8-5. Thus, the wider the slice, the greater loss of soil weight you will have for each slice. That is, the lost soil weight is the area between the bottom of slice chord and slip arc and is negligible in calculation when the slices are thinner. For ease of calculations, our examples will divide any slip arc analyzed into 20 equal width slices. To determine the height of each slice you will need to know the geometry of the circular arc and determine the x and y coordinates of the interception points of the sides of each slice with the arc. Please note that the x coordinates for either the top or the bottom of the slices are the same due to the vertical geometry of each slice. By using the y coordinates of the top and the bottom of each slice, you can calculate the average height of each slice and multiplying it by the width of the slice will provide you with the area of each slice. Once you have determined the slice areas, simply multiplying by the unit weight of soil within the slice you will have the weight of each individual slice. Once the slice weights are determined the forward sliding force (F_S) is calculated

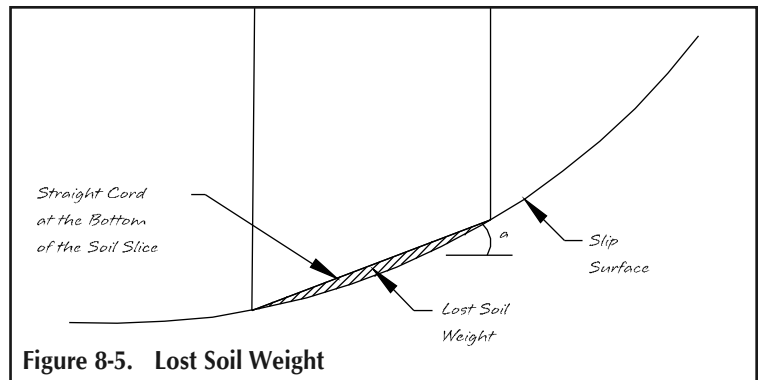

Figure 8-5. Lost Soil Weight

Therefore, the individual soil slice weight (W_j) is determined simply by multiplying the volume of soil in that slice by the unit weight of the soil. To determine the individual slice volumes the designer must determine the exact geometry of the wall section and the slip arc to be evaluated. For each slip arc there is an x and y coordinate for the entrance node and for the exit node. To determine the common width of each slice, simply determine the horizontal distance between the entrance and exit node and divide by the number of desired slices. Please note that the thinner the slice is the more accurate the weight calculations will be. For ease of calculations the bottom of each slice is assumed to be a straight cord and not the curved slip arc, see Figure 8-5. Thus, the wider the slice, the greater loss of soil weight you will have for each slice. That is, the lost soil weight is the area between the bottom of slice chord and slip arc and is negligible in calculation when the slices are thinner. For ease of calculations, our examples will divide any slip arc analyzed into 20 equal width slices. To determine the height of each slice you will need to know the geometry of the circular arc and determine the x and y coordinates of the interception points of the sides of each slice with the arc. Please note that the x coordinates for either the top or the bottom of the slices are the same due to the vertical geometry of each slice. By using the y coordinates of the top and the bottom of each slice, you can calculate the average height of each slice and multiplying it by the width of the slice will provide you with the area of each slice. Once you have determined the slice areas, simply multiplying by the unit weight of soil within the slice you will have the weight of each individual slice. Once the slice weights are determined the forward sliding force (F_S) is calculated

by multiplying the weights of the individual slices by the sine of the angle below the slice (α_j), where α_j is defined as the angle between horizontal and the bottom cord of each soil slice; α is different for each slice due to the relative location of each slice along the slip surface, see Figure 8-6.

Determination of Sliding Force (F_s):

$$F_s = \sum(W_j) * \sin(\alpha_j)$$

Where:

W_j = weight of each slice

α_j = slope of bottom of soil slice

j = slice number

Compare for a moment two slices #4 and #17. Assume that we have used the x and y coordinates and the common width of each slice to determine the individual slice areas as described above for each slice and we have multiplied the area by the unit weight of the soil to determine the following weights of slice 4 and slice 17 in Figure 8-7, $W_4 = 1000$ lb/ft (14.6 kN/m) and $W_{17} = 100$ lb/ft (1.46 kN/m). Slice 4 (W_4) is near the bottom of the slip arc where the arc ends near the facing and is relatively flat and therefore the α angle is relatively flat, say 10 degrees. The other Slice 17 (W_{17}) is near the top of the slip arc where the arc is steeper and therefore the α angle is steeper, say 60 degrees. The $\sin(\alpha_j)$ term acts as a percentage of forward movement, i.e. the flatter the angle the smaller percentage:

$$\begin{aligned} F_{s4} &= (W_4) * \sin(10^\circ) \\ &= 1000 \text{ lb/ft} (0.174) \\ &17.4\% \text{ of } 1000 \text{ lb/ft} = 174 \text{ lb/ft} \end{aligned}$$

$$\begin{aligned} &= (W_4) * \sin(10^\circ) \\ &= 14.6 \text{ kN/m} (0.174) \\ &17.4\% \text{ of } (14.6 \text{ kN/m}) = 2.54 \text{ kN/m} \end{aligned}$$

$$\begin{aligned} F_{s17} &= (W_{17}) * \sin(60^\circ) \\ &= 100 \text{ lb/ft} (0.866) \\ &86.6\% \text{ of } 100 \text{ lb/ft} = 86.6 \text{ lb/ft} \end{aligned}$$

$$\begin{aligned} &= (W_{17}) * \sin(60^\circ) \\ &= 1.46 \text{ kN/m} (0.866) \\ &86.6\% \text{ of } 1.46 \text{ kN/m} = 1.26 \text{ kN/m} \end{aligned}$$

By repeating this process for every slice and adding them all together will provide the total forward Sliding force (F_s) needing to be resisted for long term stability.

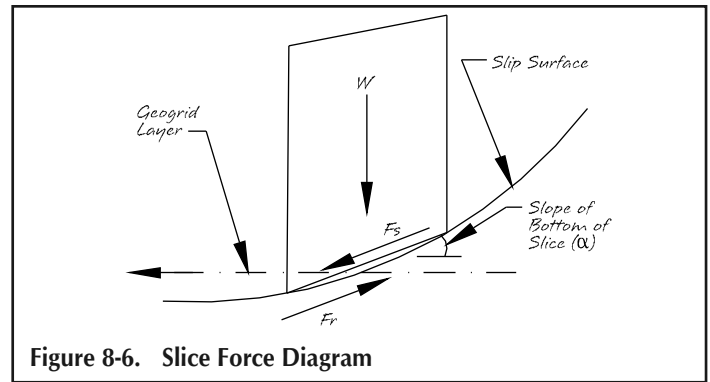

Figure 8-6. Slice Force Diagram

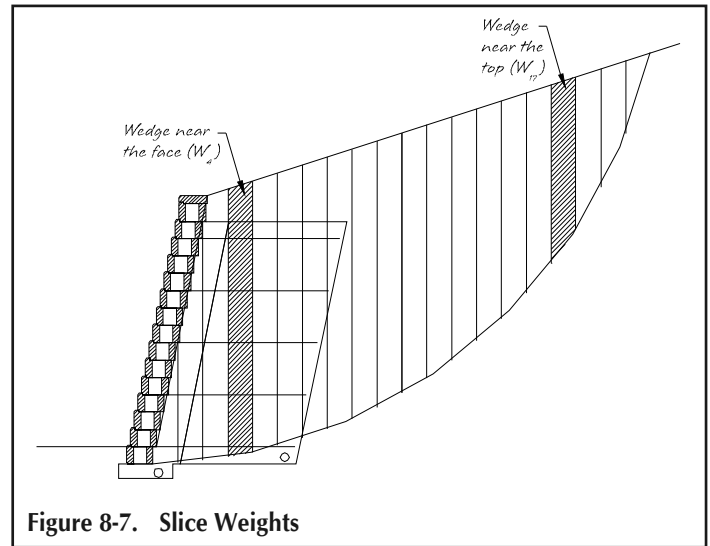

Figure 8-7. Slice Weights

Determination of Sliding Resistance (Fr):

The sliding resisting force (F_r) is calculated by multiplying the individual slice weights by the tangent of the internal friction angle of soil ($W_j * \tan(\phi)$), which is commonly used for the soil frictional interaction coefficient. However, Bishop's method then divides this term by a geometric equation called $m\alpha$; $m\alpha$ is a relationship between the strength of the soil and the relative angle of slip (α_j) for each slice and is more clearly defined in global stability textbooks or global stability modeling programs such as ReSSa+.

As these walls are utilizing a segmental block as a face, the block shear (S_{block}) is an added resistance component.

Block Shear Contribution:

Allan Block has tested their blocks for shear capacity resulting in a y-intercept and slope based on the confining pressure of the wall above in the two configurations (Block-Block (BB) and Block-Grid-Block (BGB)) as seen in Figure 8-8. For LEM Allan Block has chosen not to use the full value of the shear results to be conservative and instead uses a percentage of the y-intercept.

If the slip arcs exit at a course with a grid layer the reduction is based on the relationship between T_0 and T_{max} :

	If $T_0 < T_{max} * 25\%$	=	0 % of the BGB Y – Intercept
If $T_0 >$	$T_{max} * 25\%$ and $T_0 < T_{max} * 50\%$	=	50% of the BGB Y – Intercept
	If $T_0 > T_{max} * 50\%$	=	75% of the BGB Y – Intercept

Note: Percent multipliers are engineer judgement defined variables but are our suggestions.

If the slip arc exits at a course where there is not a layer of grid the reduction is based on the number courses between grid. If the grid is spaced every 2 courses then use 50% of the BB y – Intercept, if the grid is spaced every 3 courses then use 30% of the BB y – intercept.

Sliding Resisting Force (F_r):

$$F_r = (\sum(W_j) * \tan(\phi) / m\alpha) + S_{block}$$

Where:

W_j = weight of each slice

ϕ = friction angle of soil

$\tan(\phi)$ = soil frictional coefficient

S_{block} = shear block contribution

$$m\alpha = \cos(\alpha_j) + \frac{\sin(\alpha_j) \tan(\phi)}{FS_i}$$

Where:

α_j = slope of bottom of soil slice

FS_i = initial safety factor = 1.0 for LEM

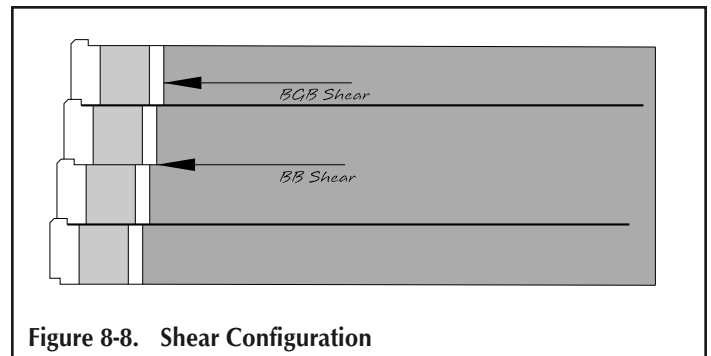

Figure 8-8. Shear Configuration

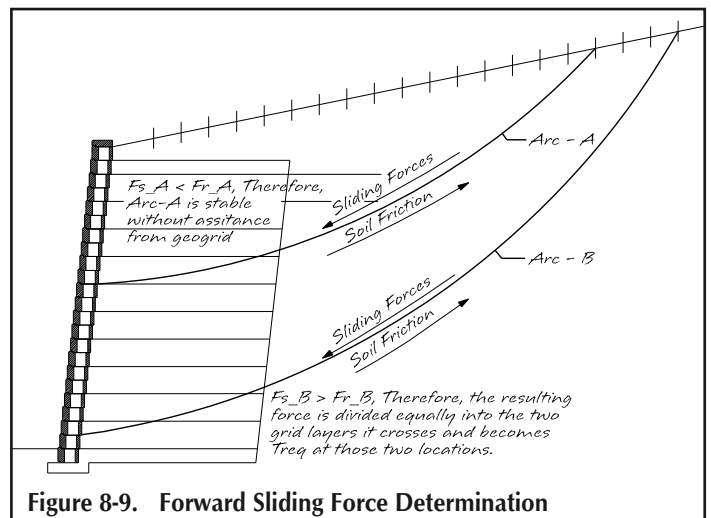

Figure 8-9. Forward Sliding Force Determination

Where FS_i is the initial safety factor used to start the iteration process in the ICS calculations and global modeling but in LEM, as mentioned earlier, FS_i is set to 1.0 to remove the iteration process and create a baseline result for equilibrium. The baseline results can be defined as the total sliding force, which is simply the sum of all sliding forces (F_S) minus the sum of all resisting forces (F_r). More simply, if $F_S - F_r$ is greater than zero (Arc-B in Figure 8-9) the result is then divided into each grid layer the slip arc comes in contact with. This methodology assumes that for each slip arc the sliding forces that exceed the resisting forces are evenly distributed between each layer of grid that is intersected by the arc. This assumes that the grid at either end has sufficient pullout capacity for the soil or facing to mobilize the strength of the grid and therefore contribute to the stability along the slip arc. Furthermore, if $F_S - F_r$ is less than zero (Arc-A in Figure 8-9), the slip arc is stable by itself and thus the full shear resistance along the slip arc exceeds the forward sliding force and thus no resisting force is required from the geogrid layers.

Transfer of Bishops Determined Forces to each Grid Layer (T_{req})

As mentioned above, once the total forward sliding force has been determined, that force is divided equally into each grid layer the arc intersects by using the sum of the Cosine's of the intersecting angles with each grid layer, see Figure 8-10. Like we discussed above for the slice geometry, you must determine the intersection angle of the geogrid layer and the individual slip arcs. Again, this is done by analyzing the geometry of the circular slip arc and known vertical position of each grid layer.

The following equation is then used for T_{req} :

$$T_{req} = (\sum F_S - \sum F_r) / \sum \cos(\alpha_{grid})$$

Where:

F_S = sliding forces

F_r = resisting forces

α_{grid} = intersection angle between grid and slip arc

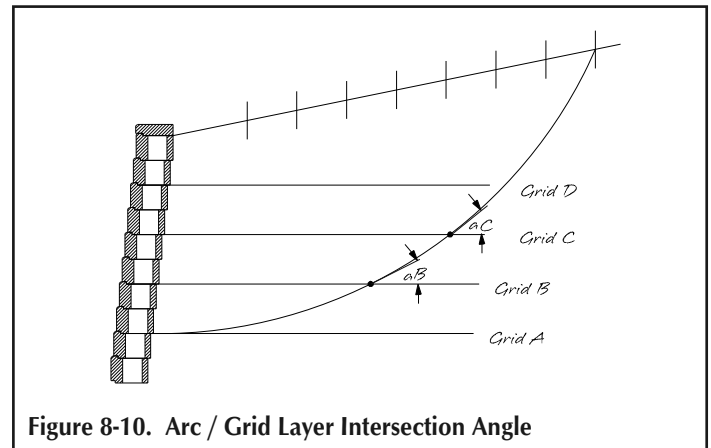

Figure 8-10. Arc / Grid Layer Intersection Angle

Using a top-down analysis approach, meaning, starting with all slip arcs exiting the wall at or near the top, one can start to develop the worst case T_{req} values. Consider arcs #1 and #2 exiting the wall between Grids D and C shown in Figure 8-11. Each arc only intersects the top layer, Grid D and thus any forward force determined by the Bishops model would be applied to only this one grid layer. Similarly, any arcs that exit the wall between Grids B and C (Arcs #3 and #4) could intersect up to two grid layers and thus the Bishop force would be equally divided into the two intersected layers. It is highly possible that the T_{req} calculated for the top layer could exceed the equally divided force thus it is imperative that we start from the top and work down. Take for instance Arc #5 shown. Even though it exits the wall lower than the other examples shown, it only intersects Grids B and C due to the fact the Grid D is not long enough to intersect Arc #5. If you were to review the intersection position of every arc in a particular wall analysis this would be very common. Therefore, again, the use of a modeling program is imperative to track all the individual arcs. This process is repeated for every possible slip arc and all T_{req} values are recorded for each particular arc/grid-layer intersection point thus creating a T_{req} envelope of each grid layer as shown in Figure 8-3. From this envelope, all geogrid information will be found including strength, soil pullout and connection requirements. This envelope provides the required information to move forward with the geogrid portion of the LEM analysis.

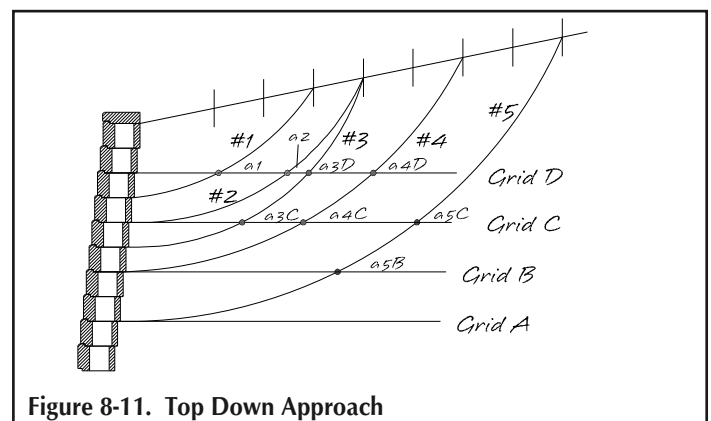

Figure 8-11. Top Down Approach

Geogrid Pullout Requirements (Part II of the LEM Analysis) (P_{front}, P_{end})

The geogrid pullout calculations in the LE Method are entirely separate from the Bishops side. The pullout envelope is calculated along each geogrid's exposed length (L') from the end of the grid layer, referred to as the "end" (P_{end}) and from the back of the block (P_{front}), defining connection requirements, Figure 8-12. The goal here is to develop a pullout envelope of resistant forces that entirely surrounds the T_{req} force envelope from the Bishops analysis. This is very much different than ICS where the grid interaction was part of the overall safety factor equation. To start, each grid layer's initial exposed length (L') and position within the wall is defined in the Bishops model. Using these set lengths and positions, we analyze each grid layer separately, as shown by Grid_A and Grid_B in Figure 8-3.

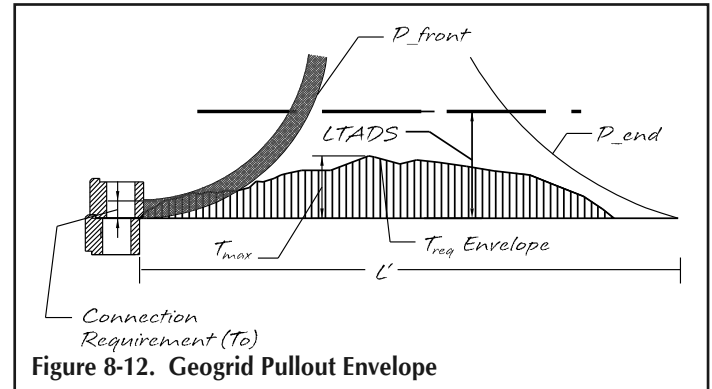

Figure 8-12. Geogrid Pullout Envelope

To determine the pullout capacity and resulting graphical curve, start by dividing the exposed length of each grid layer (L') into n equal segments from the back of the facing to the end of the grid, 3s shown in Figure 8-13. Thus the length of each grid segment is $dl = L'/n$. Note, that the more segments used, the more accurate the results will be because of the refinement of the confining pressure. For our analysis we divide the length of each grid into 1 inch (25 mm) segments to determine the P_{front} and P_{end} results curves. It should be noted that due to the rapidly increasing P_{front} and P_{end} curves, they will never cross or intersect. As with any geogrid pullout calculations, there comes a point where the pullout calculations results exceed the Long Term Allowable Design Strength (LTADS) of the grid and then grid rupture controls the design. Likewise for this discussion the defining upper limit of the P equations will be the LTADS of the geogrid used.

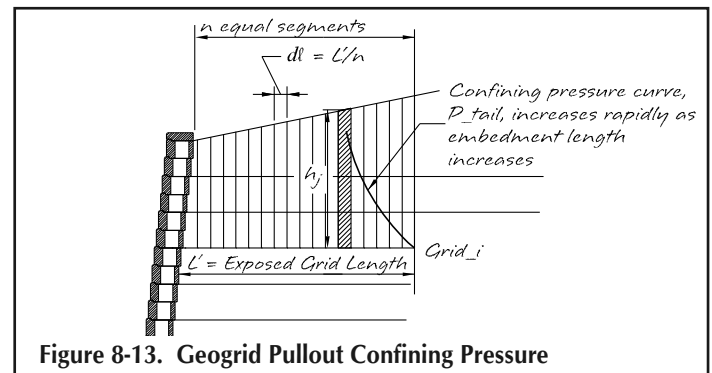

Figure 8-13. Geogrid Pullout Confining Pressure

As with any geogrid pullout calculations, there comes a point where the pullout calculations results exceed the Long Term Allowable Design Strength (LTADS) of the grid and then grid rupture controls the design. Likewise for this discussion the defining upper limit of the P equations will be the LTADS of the geogrid used.

The SRW industry has used the same geogrid pullout of soil equation since their introduction:

$$P = \gamma * h_g * L_e * (2 * C_i * \tan \phi)$$

where:

ϕ = friction angle of the soil above the grid layer

γ = unit weight of soil above the grid layer

L_e = embedment depth of the geogrid

h_g = average Height of soil above L_e

C_i = geogrid interaction coefficient provided by the geogrid manufacturer

The LE method uses this exact same equation but refines how the confining pressure is determined by incrementally creating the embedment depth and combining the n_j segments in a way to create an increasing force/embedment curve. Therefore, the height of each segment n_j (h_j) combined with the width of segment n and its unit weight of soil becomes the confining pressure above segment j. By repeating the calculations for each segment n_j , we can determine the pullout resistance at each segment relative the increasing embedment length of the grid. Thus, the pullout capacity can be found anywhere along the grid's length, developing a pullout of soil envelope to compare to the T_{req} envelope developed by the Bishop's results.

LEM Pullout of soil resistance equation (P):

$$P = \sum \gamma h_j (2 * C_i * \tan \phi) dl$$

Where:

- ϕ = friction angle of the soil above the grid layer
- γ = unit weight of soil above the grid layer
- h_j = height of soil above the n_j grid segment
- $\gamma h_j dl$ = the confining pressure above the n_j grid segment
- C_i = geogrid interaction coefficient provided by the geogrid manufacturer

This exact equation and analysis process is performed along each grid layer starting from the end of the grid, working towards the front (for pullout of soil limitation) and then vice versa, from the front of the grid towards the end (for determining the required facial contribution from connection and shear). These overlapping data curves form the pullout resistance envelope (Figure 8-14) that can then be compared to the Bishop's determined T_{req} envelope.

Depending on how complicated a design analysis you are performing, the confining pressure portion of the soil resistance equation can be expanded to include seismic (k_v), cohesion (Ds_j) and water pressure (u_j)

$$P = \sum (1 \pm K_v)(\gamma h_j + Ds_j - u_j)(2 \times C_i \tan \phi) dl$$

Note: Although cohesion is commonly used in global modeling programs it is inherently unstable due greatly to its unpredictable nature when water is introduced into the slope or wall system. Also, it is industry practice to be conservative and never use cohesion in soil pullout calculations. Therefore cohesion will not be allowed in the LEM soil pullout calculations.

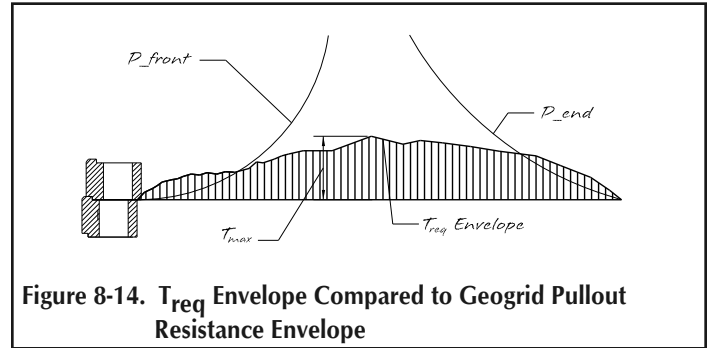

Figure 8-14. T_{req} Envelope Compared to Geogrid Pullout Resistance Envelope

Using Soil Pullout Calculations to Determine Proper Length of Geogrid Layers, Required Geogrid Strength and Connection Requirements

The LEM framework is set up to be very straight forward by isolating the geogrid pullout resistance at the end and at the front of each grid layer. When comparing the T_{req} results from the Bishop's model to the soil pullout envelope, P , the connection requirement (T_0) is found at the front and soil pullout capacity limitation is found at the end, as shown in Figure 8-15.

If $T_{req} > P$ = front = Connection requirement
 = end = Pullout Capacity Limitation

Conversely, if P_{front} or P_{end} does not intersect T_{req} envelope it would indicate there is no load on the face of the surface or that the grid at the back of the structure has enough soil pullout capacity.

Specifically for connection consideration, if $T_{req} > P$ happens at the front, the translated difference becomes the required minimum connection capacity, T_0 . To determine T_0 , the pullout results P_{front} is simply translated upward to a point where it coincides or exceed the T_{req} results curve. Doing this calculations by hand is difficult however, because we have determined through calculations the T_{req} and P_{front} results at virtually every location along any particular grid layer, you could isolate the results for both at common locations and simply subtract T_{req} from P_{front} and come up with the worst case difference.

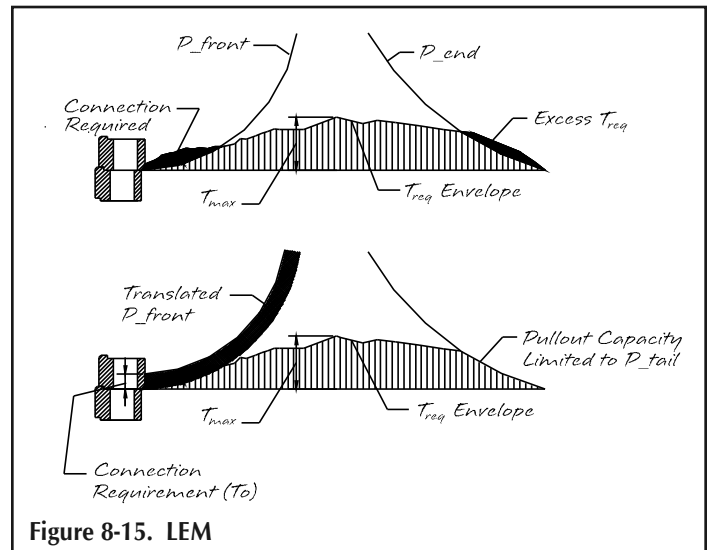

Figure 8-15. LEM

As an Industry we know that there is little to no force at the back of the face, as shown in the T_o calculations. To account for inconsistencies and unknown site conditions an additional Force Between Grids (F_{bg}) is applied to T_o .

$$\text{Minimum Connection Requirement} = T_o + F_{bg}$$

Where:

$$F_{bg} = \gamma * K_{ai} * H' * w * 100\%$$

Where:

w = width of column

γ = unit weight of soil above the grid layer

K_{ai} = active pressure coefficient for infill soil

H' = height from exit node to top of wall (height of column)

Using standard soil mechanics, the Force Between Grids can be calculated based on grid spacing to determine the column width of soil that creates the bin pressure at the back of the block. The engineer can decide, based on their judgement, how much of the bin pressure to be applied with the percent multiplier at the end.

Specifically for Soil Pullout capacity, if $T_{req} > P$ happens at the end of the grid, T_{req} is limited by P , as shown in Figure 8-15. The excess T_{req} is then redistributed to the remaining grids that intersect the slip arc to maintain equilibrium.

$$T_{req} - P = \text{Excess } T_{req}$$

$$\text{Excess } T_{req} / \# \text{ of remaining grids.}$$

Note: Soil Pullout can be the limiting capacity for multiple grids on a single slip arc.

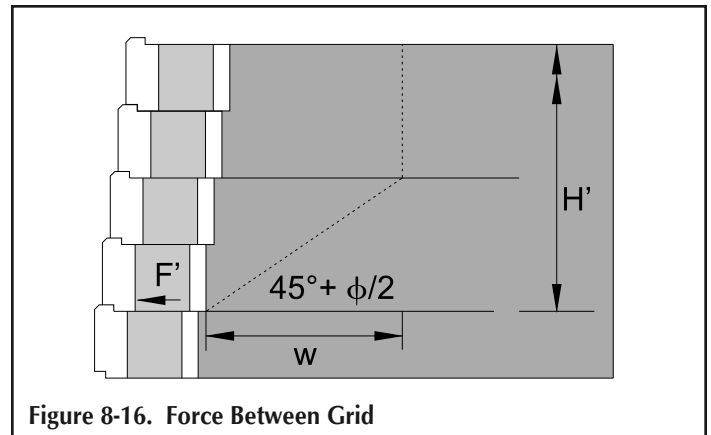

Figure 8-16. Force Between Grid

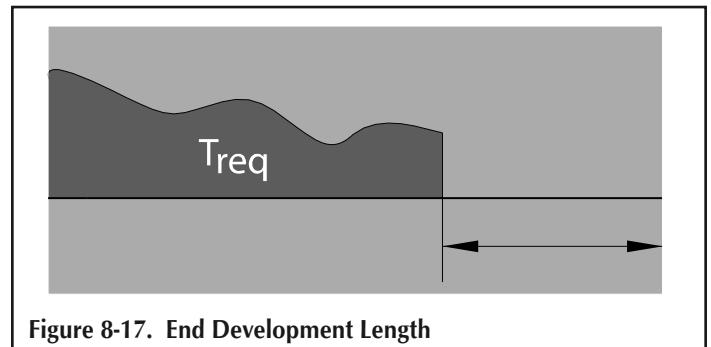

Figure 8-17. End Development Length

To account for installation and site inconsistencies the engineer can define a End Development Length. By defining a End Development Length, the engineer is stating that if a slip arc intersects a grid within this length, that grid layer is ignored for the T_{req} calculations for that slip arc and the loading is distributed to the remaining grids.

Note: Under certain circumstances, such as terraces and longer grids at the top, a slip arc may pass through multiple layers of grid within the End Development Length.

External Stability Calculations

Since the beginning of SRW designs there have been three essential parts of any design, External, Bearing and Internal calculations needing to be satisfied. External calculations are all about the overall size of the mass and whether or not it is large (or heavy) enough and deep enough to resist sliding and overturning forces developed from the active earth pressure from the retained soils. The depth of mass is commonly equated with the length of the common geogrid layers but other than the grid length it has nothing to do with the strength or position of the grid layers. Our years of wall design experience has told the industry that the depth of any wall mass should be no thinner than 60% of the

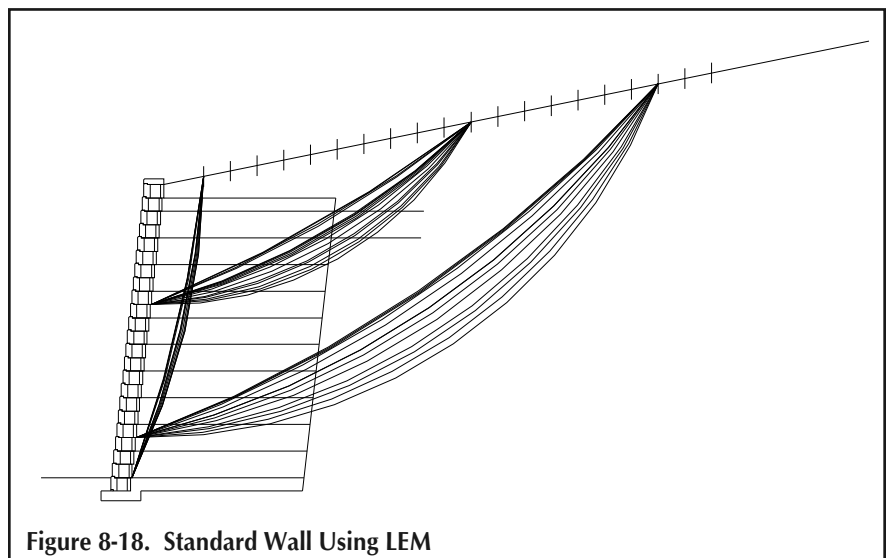

Figure 8-18. Standard Wall Using LEM

wall height, i.e. a 10 ft wall (3.0 m) should have minimum grid lengths of at least 6 ft (1.8 m). This is not to say that under the proper guidance of a qualified engineer a reinforced mass cannot be designed thinner than 60%, it just says that the industry has deemed 60% to be a best practice. This concept of External design is still very relevant today and will not be affected by the introduction of LEM. The same goes for the traditional SRW Bearing calculations. A commonly used bearing calculation is based on Meyerhof formulas that again are still very relevant today and will not be affected by the introduction of LEM. The traditional Internal calculations however do change. This entire LEM discussion has been put forth as a new, more accurate method to entirely replace the old Internal calculations. Internal calculations are intended to accurately determine the forces within the reinforced mass by including the strength and position of the geogrid layers.

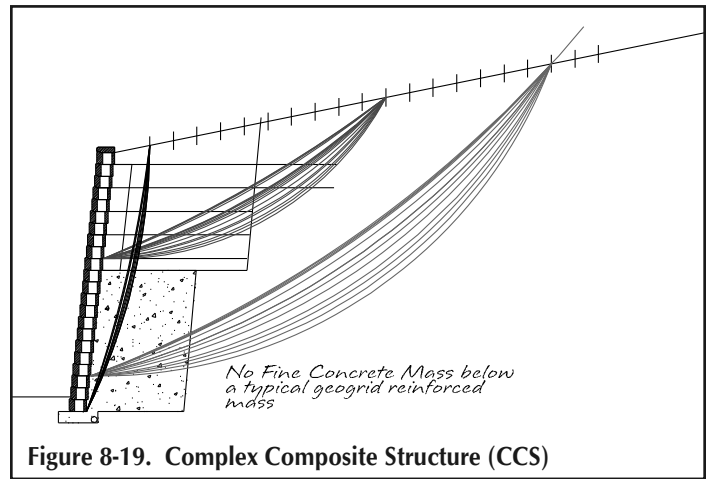

Figure 8-19. Complex Composite Structure (CCS)

The traditional active earth pressure determined Internal calculations have become, over time, too conservative and have been proven to be inaccurate when compared to monitored structures. On the other hand, global stability modeling has become more common with the introduction of more powerful computing software such as ReSSA and others and has been proven to be very accurate in determining actual forces in monitored structures or slopes. This understanding was the catalyst for the LE methodology developed by University Professor Dov Leshchinsky, PH.D. and adopted by the Federal Highway Administration (FHWA) and the National Concrete Masonry Association (NCMA).

ICS was developed in 2007 as a way to provide a higher level of check to the internal calculations. With the introduction of LEM, which is built upon the foundation, which is ICS, one may consider ICS obsolete. While some parts are redundant, ICS can provide a check to the internal structure of the reinforced mass. Therefore, once the LEM model is complete and all grid depths, strengths and positions have been vetted with LEM, the designer should run the ICS calculations as a check for the overall system, but it is not required.

Lastly, it is highly recommended that with any LEM design a global analysis is run to ensure overall stability of the site.

Discussion on Various Structure Types and Grid Configurations

As mentioned earlier, the fact that LEM is based on global modeling allows the designer to utilize the same technical methods to analyze structures of virtually any configuration including terraced walls (Figure 8-19) or walls that are considered complex having a combination of geogrid and no-fines concrete making up its internal structure (Figure 8-20). For each model, slip arcs and resulting T_{req} and T_{max} values would be calculated using the same Bishop's method and based on the geometry and position of any no-fines concrete or geogrid layers, the pullout from front and back of grid would be determined the same way as well. Once the Bishop's forces are determined, the comparison of required loads and available capacities break down to a grid by grid analysis, so complexity or wall configuration plays no roll.

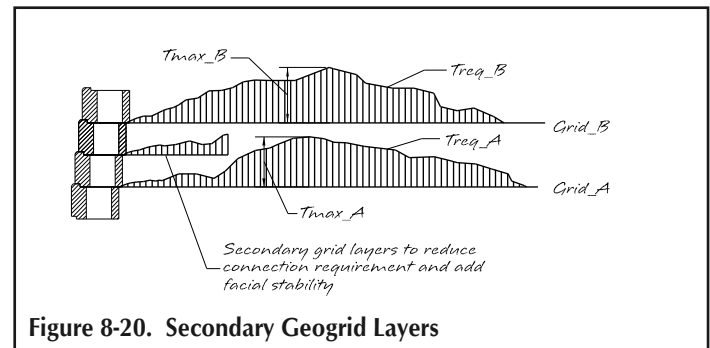

Figure 8-20. Secondary Geogrid Layers

Lastly, the addition of secondary short grid layers (Figure 8-20) is becoming more common in some applications as well. The industries current Internal design method is not able to correctly utilize them in facial stability calculations. Using them in LEM is very straight forward as they are only relative to the facing. Therefore, we only use them in the front end pullout of soil calculations which specifically allows us to determine the required connection strength. They become another layer of grid to divide equally the Bishop's forces by effectively reducing the loads at the face thus reducing the amount of required connection or shear from the facing units.

Terraced Walls

Sometimes it is desirable to build two or more smaller walls at different elevations rather than one very tall wall. Such an arrangement is called a terraced wall and an example is pictured in Figure 8-21. The analysis of terraced walls can become very complicated. Before LEM a standard design method was used to analyze terraced wall applications, as described below.

The first step in designing a terraced wall is to decide what the total height of all the walls will be, how many tiers there will be and the height of each tier. Each wall should be designed using a minimum grid length based on the total height of all the walls. Please note that the design grid lengths for the lower wall are often longer than the calculated minimum due to global stability requirements. Then, using the design procedures presented earlier in Chapter 3, design the top retaining wall. Next, find the average bearing stress of the top wall on the underlying soil. This average bearing stress is then applied as a uniform surcharge to the retained soil mass of the second wall from the top. (See Figure 8-22) The second wall is then analyzed using the procedures described earlier in Chapter 3.

The process is repeated until all of the tiers have been analyzed. As a final step, check the maximum soil bearing pressure of the bottom wall to make sure it doesn't exceed the allowable bearing pressure of the onsite soil.

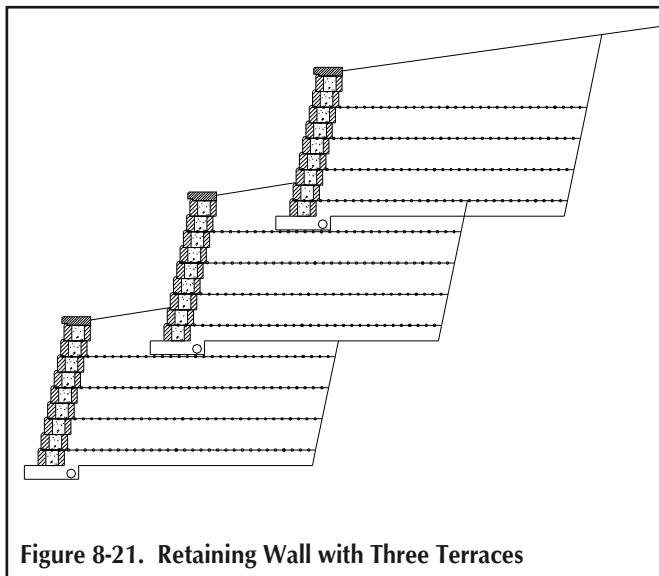

Figure 8-21. Retaining Wall with Three Terraces

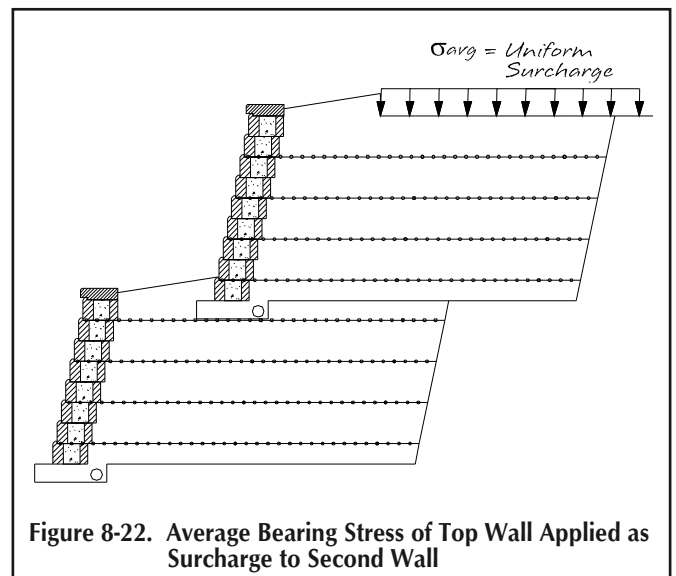

Figure 8-22. Average Bearing Stress of Top Wall Applied as Surcharge to Second Wall

Now with the use of LEM, which is essentially a global analysis calculation that is limited to the wall design envelope, designing terraces is even simpler. The beginning steps are the same, such as determining the number of terraces, their heights and their spacing, but with LEM the bearing calculation is no longer necessary as it is included in the LEM calculations.

You should also be aware that, as the number and walls increase, the threat of global instability increases. A terraced wall consisting of three 5 ft (1.52 m) walls can have as great an impact on the underlying soil as a single 15 ft (4.6 m) wall. The need for a full global analysis should be conducted with terraced wall applications.

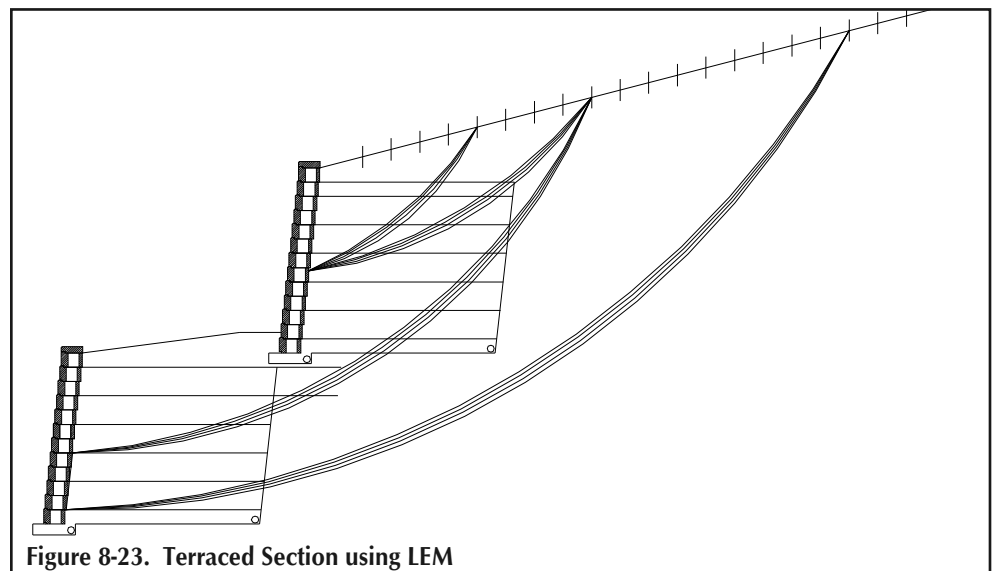
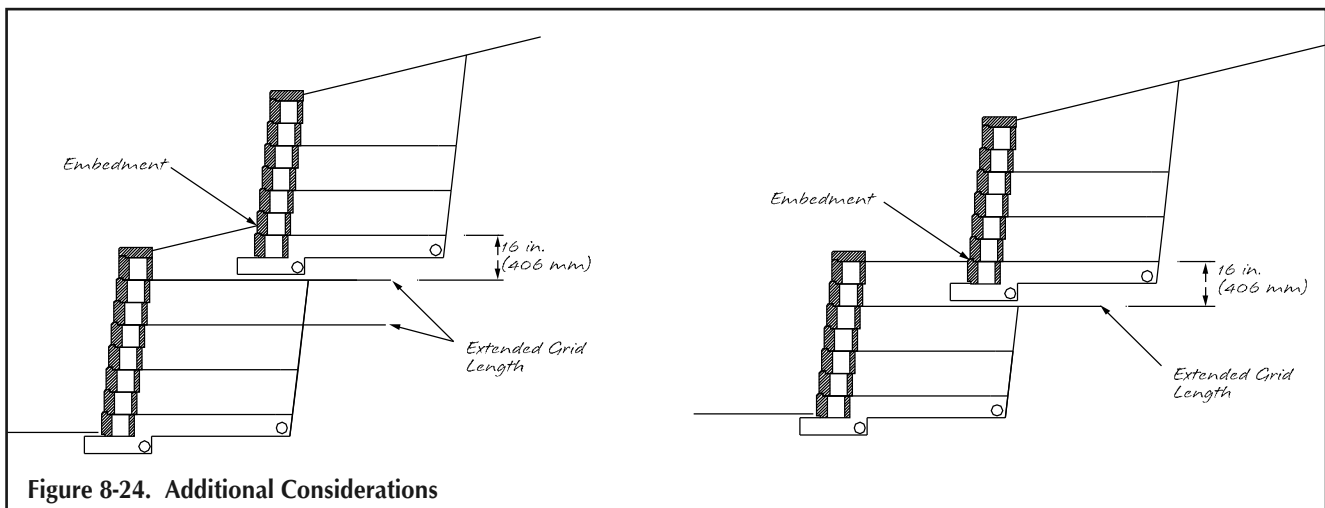

Figure 8-23. Terraced Section using LEM

As every site and project is unique, here are some additional design considerations for terraced walls.

- In Chapter 2 Allan Block recommends that the spacing of grid is set to no more than 2 course spacing – 16 inches (406 mm). This spacing should also be maintained in a terraced application by setting the wall heights to an even number of courses so the elevations of the grid layers hold to a 16 inch (406 mm) spacing.
- While maintaining the 2 course spacing throughout the terraced structure also make sure that proper embedment is followed for each terrace with the use of more buried block or slopes between walls.
- Another consideration is water management. The engineer should ensure that proper water management is utilized to prevent water from being introduced into the lower terraces.
- Compaction is another aspect to be considered. Additional compaction and testing requirements should be specified for below the upper terraces. It is also recommended to ensure the top layers of geogrid of the lower structures are extended past the leveling pad of the upper terraces. This is to ensure there is little to no differential settlement throughout the upper wall structures.



Design Example

Below we will show the calculations for an LEM example. It is not possible to show all calculations for every possible slip arc so we will show everything related to one single slip arc.

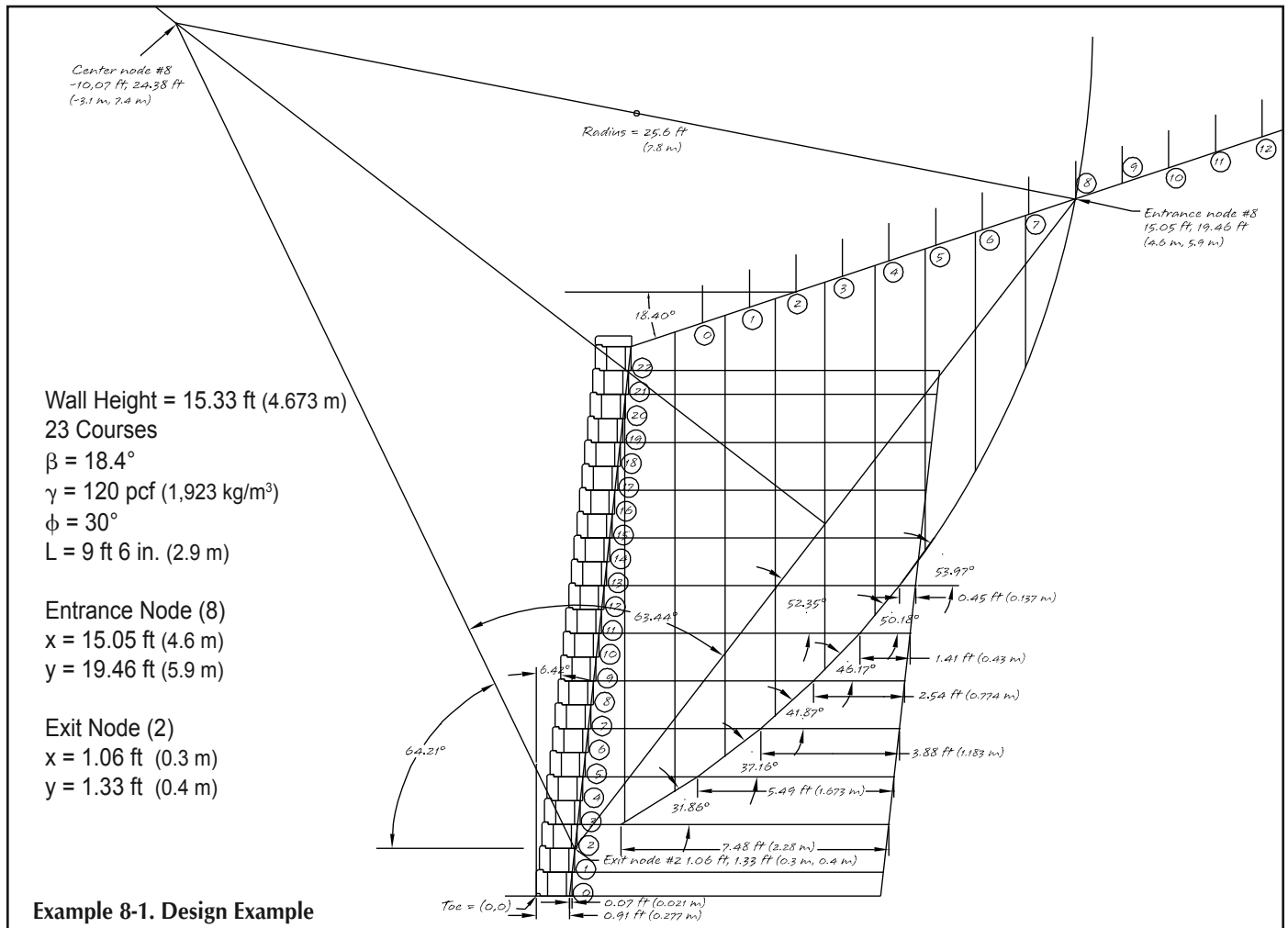

$$\text{Cord Length}^* = \sqrt{(x_{\text{ent}} - x_{\text{exit}})^2 + (y_{\text{ent}} - y_{\text{exit}})^2}$$

$$= 22.9 \text{ ft (7.0 m)}$$

$$A_{\text{Cord Slope}} = \text{atan} \left[\frac{(y_{\text{ent}} - y_{\text{exit}})}{(x_{\text{ent}} - x_{\text{exit}})} \right]$$

$$= 52.35^\circ$$

$$B_{\text{Angle}} = \text{atan} \left[\frac{\text{center cord length}}{0.5 \text{ cord length}} \right]$$

$$= 63.44^\circ$$

* The Center Cord Length dimension is the first radius node and can vary but for this example it will be set equal to the cord length.

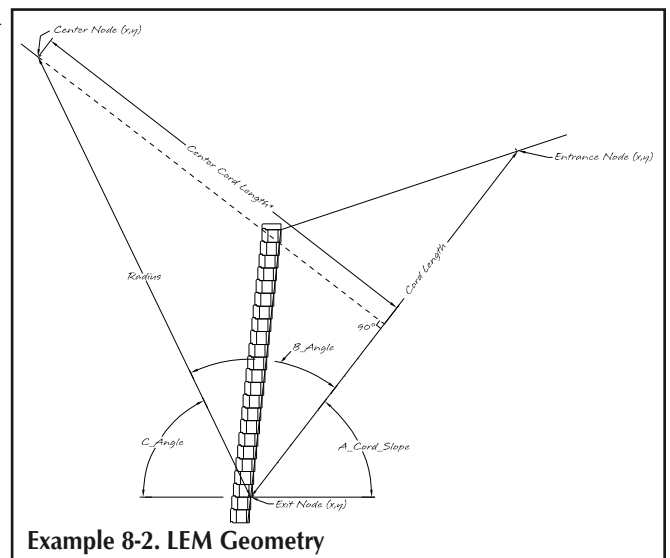

Note: With the coordinates of the entrance and exit nodes, geometry can be used to determine angles A, B, and C, the cord radius, and the center node coordinates.

$$\begin{aligned}
C_Angle &= 180^\circ - A_Cord_Slope - B_Angle \\
&= 64.21^\circ \\
Radius &= \sqrt{(0.5 \times cord_length)^2 + (center\ cord\ length)^2} \\
&= 25.6\ ft\ (7.8\ m) \\
Center\ Node\ X &= x_exit - \cos(C_Angle) \times center\ cord\ length \\
&= -10.071\ ft\ (3.07\ m) \\
Center\ Node\ Y &= y_exit - \sin(C_Angle) \times center\ cord\ length \\
&= 24.38\ ft\ (7.43\ m)
\end{aligned}$$

Determine Wedge Geometry, Area & Weight

Note: For this example we will use 10 equal width wedges.

$$Wedge\ Thickness = \frac{(x_ent - x_exit)}{10} = 1.399\ ft\ (0.43\ m)$$

Using the geometry of the facing (j), slope above (i) and the geometry of the arc one can calculate the exact coordinates of the corners of all wedges.

Using the four y coordinates, the wedge thickness and unit weight of soils, the average wedge heights, area and weight, can be determined for each wedge.

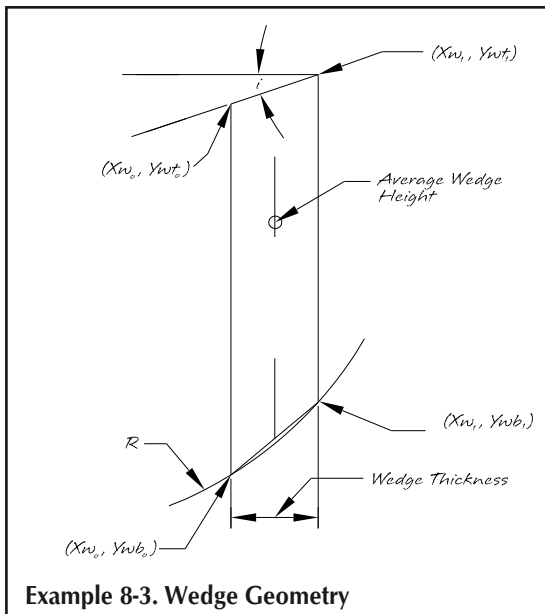

Wedge Area = Table 7-1 Average Wedge Height x Wedge Thick	
0	8.2 ft ² (0.76 m ²)
1	18.1 ft ² (1.68 m ²)
2	17.6 ft ² (1.64 m ²)
3	16.8 ft ² (1.56 m ²)
4	15.7 ft ² (1.46 m ²)
5	14.4 ft ² (1.34 m ²)
6	12.7 ft ² (1.18 m ²)
7	10.56 ft ² (0.98 m ²)
8	7.6 ft ² (0.71 m ²)
9	3 ft ² (0.28 m ²)

Wedge Weight = Table 7-2 Wedge Area x Unit Weight of Soil (γ)	
0	909.8 plf (13,282 kN/m)
1	2168.8 plf (31,661 kN/m)
2	2110.8 plf (30,815 kN/m)
3	2000.3 plf (29,201 kN/m)
4	1887.2 plf (27,550 kN/m)
5	1728.4 plf (25,232 kN/m)
6	1527.1 plf (22,294 kN/m)
7	1267.4 plf (18,502 kN/m)
8	915.3 plf (13,363 kN/m)
9	355.2 plf (5,185 kN/m)

Surcharges

Like global stability modeling and ICS calculations any surcharge above the soil wedges are added directly to each individual affected wedge. For this example no surcharge was added.

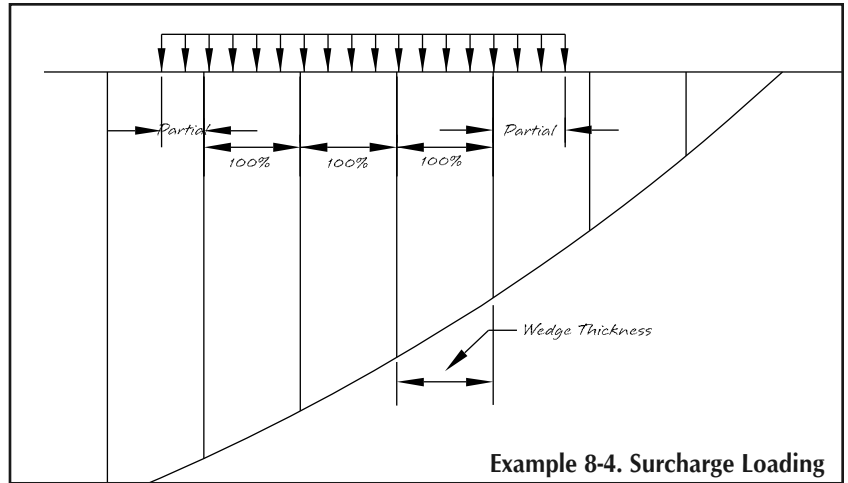

Example 8-4. Surcharge Loading

Note: Any surcharge above gets added to the individually affected wedges. For this example no surcharge was added.

Determine Slope at Bottom of Each Wedge

$$\alpha_{\text{wedge}} = \text{atan} \left[\frac{Y_{wb_1} - Y_{wb_0}}{X_{w_1} - X_{w_0}} \right]$$

Calculate Bishops m_{α} Term

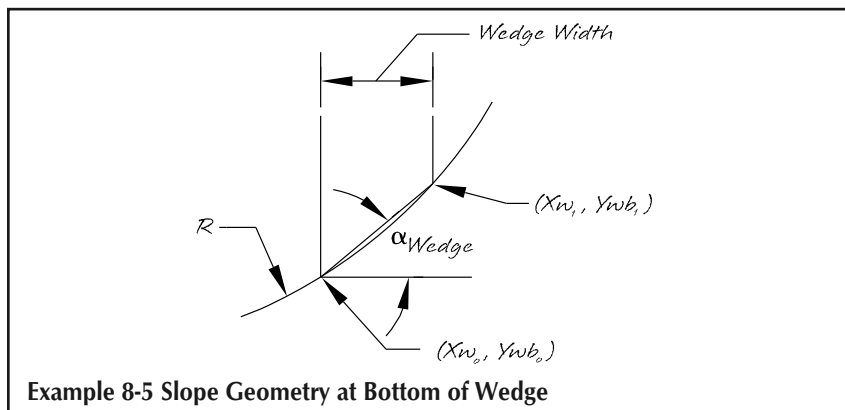

Example 8-5 Slope Geometry at Bottom of Wedge

$$M_{\alpha_{\text{wedge}}} = \cos \alpha_{\text{wedge}} + \left[\frac{\sin(\alpha_{\text{wedge}}) \times \tan \phi_w}{\text{safety factor}} \right]$$

Note: the LE method uses the safety factor of 1.0 to eliminate the iterative process used by Bishop. Doing so forces the results to show values at equilibrium.

wedge	α_{wedge}
0	24.071°
1	27.551°
2	31.145°
3	34.883°
4	38.8°
5	42.947°
6	47.399°
7	52.271°
8	57.765°
9	64.314°

Table 7-3

wedge	$M_{\alpha_{\text{wedge}}}$
0	1.149
1	1.154
2	1.154
3	1.151
4	1.141
5	1.125
6	1.102
7	1.069
8	1.022
9	0.954

Table 7-4

Calculate Sliding Resistance (Fr) due to Soil Weight, Surcharges and Soil Friction Interaction

$$F_{r_w} = \frac{(W_{t_{wedge}} + W_{t_{surcharge}}) \tan \phi}{M_{\alpha_{wedge}}}$$

Sum of Resisting Forces

$$\Sigma Fr = 7,661 \text{ plf } (111,839 \text{ kN/m})$$

wedge	F_{r_w}	Table 7-5
0	457.3 plf (6,676 kN/m)	
1	1085.4 plf (15,845 kN/m)	
2	1055.6 plf (15,410 kN/m)	
3	1003.8 plf (14,654 kN/m)	
4	954.8 plf (13,939 kN/m)	
5	886.7 plf (12,945 kN/m)	
6	800.2 plf (11,681 kN/m)	
7	684.8 plf (9,997 kN/m)	
8	517.2 plf (7,551 kN/m)	
9	215.0 plf (3,139 kN/m)	

Calculate Total Sliding Forces (Fs_w) due to Soil Weight, Surcharge, and Slope Angle at Bottom Wedge

$$F_{s_w} = (W_{t_{wedge}} + W_{t_{surcharge}}) \sin (\alpha_{wedge})$$

$$\Sigma F_{s_w} = 9,191 \text{ plf } (134,175 \text{ kN/m})$$

wedge	F_{s_w}	Table 7-6
0	371.1 plf (5,417 kN/m)	
1	1003.1 plf (14,644 kN/m)	
2	1091.7 plf (15,938 kN/m)	
3	1144.0 plf (16,700 kN/m)	
4	1182.5 plf (17,263 kN/m)	
5	1177.6 plf (17,191 kN/m)	
6	1124.1 plf (16,410 kN/m)	
7	1002.4 plf (14,634 kN/m)	
8	774.3 plf (11,303 kN/m)	
9	320.1 plf (4,673 kN/m)	

Seismic Forces

Seismic loading is very straight forward in Bishops modeling. Simply take the sliding forces of each individual wedge and multiply by the seismic coefficient (kh). Where: kh is a function of the peak ground acceleration (Ao), wall geometry, soil parameters and allowable wall movement during a seismic event. For this example no seismic loading was added.

where:

$$kh = 0$$

$$D_{yn_F_w} = F_{s_w} \times kh = 0$$

Total Sliding Forces (Fs)

$$F_s = F_{s_w} + D_{yn_F_w}$$

$$\Sigma F_s = 9,191 \text{ plf } (134,175 \text{ kN/m})$$

Total forward sliding forces to be resisted be effected grid layers.

$$F_{s_{forward}} = \Sigma F_s - \Sigma Fr = 9,191 \text{ plf} - 7,661 \text{ plf} = 1,530 \text{ plf}$$

$$= 134,175 \text{ kN/m} - 111,839 \text{ kN/m} = 22,336 \text{ kN/m}$$

Note: If the $F_{s_{forward}}$ result is negative there is no forward sliding force generated from that slip arc. In other words that arc is stable.

For this arc example we need to transfer the $F_{s_{forward}}$ result to the grid layers the arc crosses. This equally divided force will be known as T_{req} at the specific location the arc intersects the grid layer.

Determine the Arc/Grid Intersection Locations and Relative Angle Between the Horizontal Grid Layer and the Arc.

For this example arc, grids 2 through 7 are crossed. Geometry will provide the intersection angle and location.

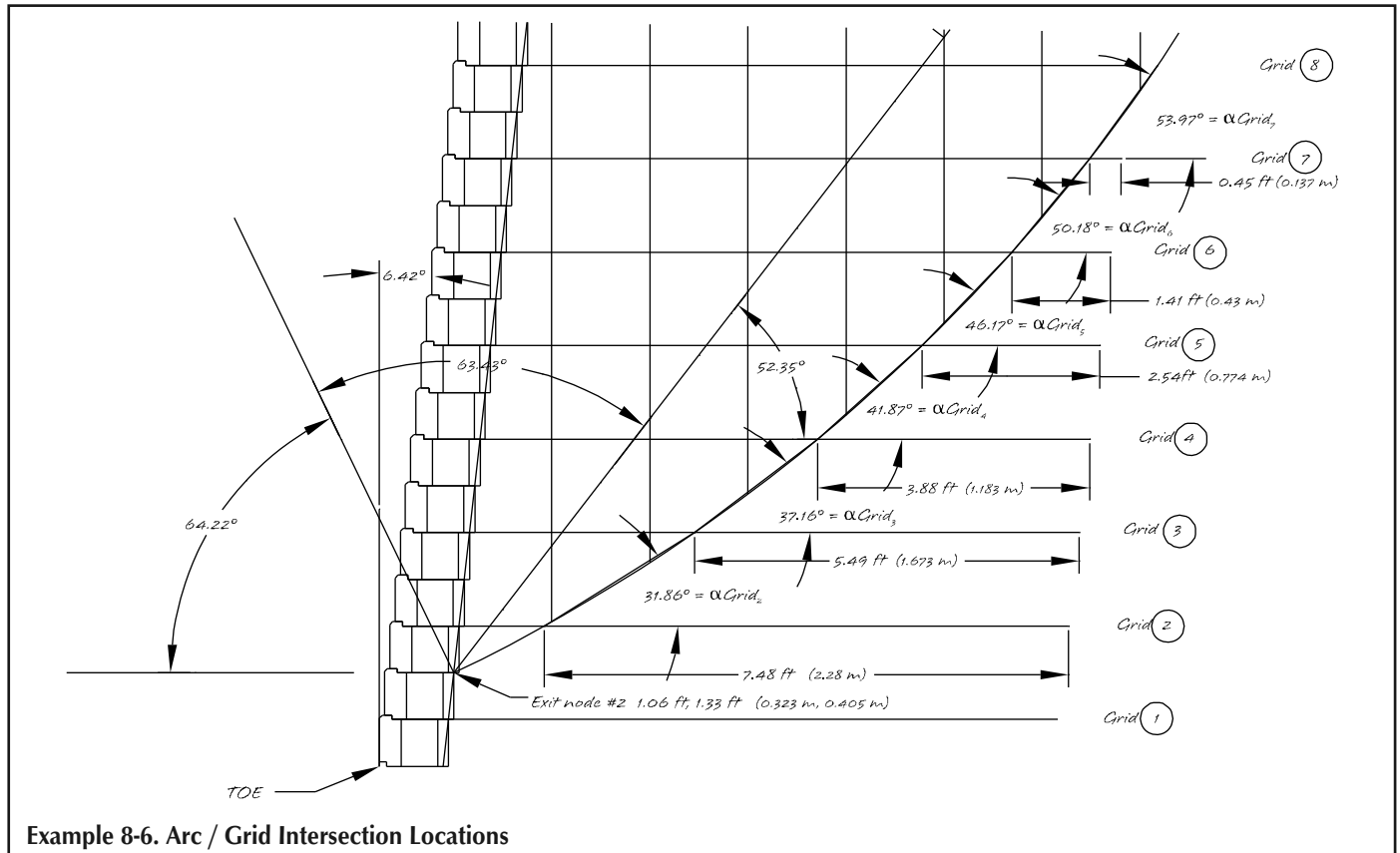

Determine T_{req} for Each Intersected Grid Location

Once forward sliding force ($F_{sforward}$) and the α_{grid} angles between the arc and the intersected grid layers have been determined T_{req} can be calculated.

$$\begin{aligned}
 T_{req} &= \frac{\sum F_s - \sum F_r}{\sum \cos(\alpha_{grid})} \\
 &= \frac{9,191 \text{ plf} - 7,661 \text{ plf}}{4.312} \\
 &= 355 \text{ plf}
 \end{aligned}$$

$$\begin{aligned}
 &= \frac{134,175 \text{ kN/m} - 111,839 \text{ kN/m}}{4.312} \\
 &= 5,182 \text{ kN/m}
 \end{aligned}$$

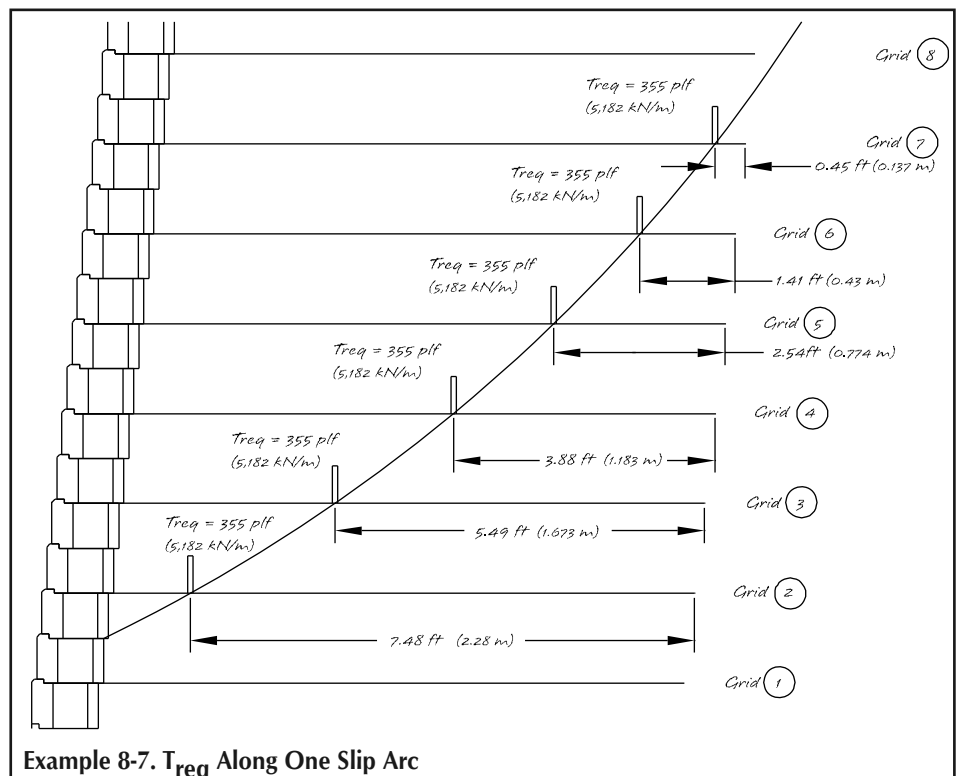

At this point we have completed the Bishops side of the LE method for one arc. By following this exact process for every possible slip arc, a designer can calculate the T_{req} at every location along each grid layer. Please note that for a wall with 23 courses, 21 entrance nodes, and 20 arc radius center nodes there are nearly 9700 arcs to analyze.

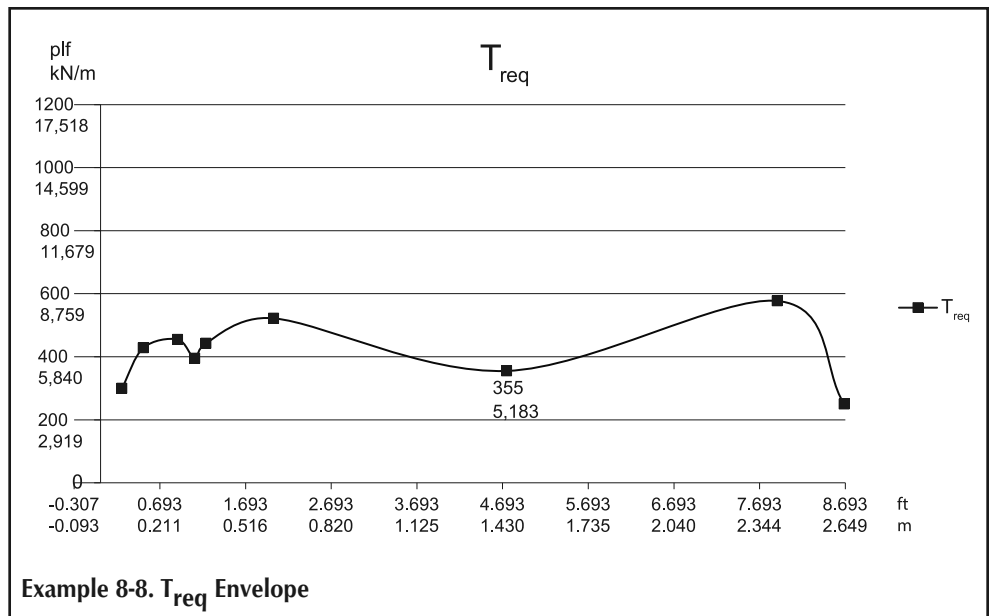

Geogrid Soil Pullout

This section is technically entirely separate from the Bishops side of LEM. Now we will determine the pullout of soil curves for each layer of grid that will be ultimately compared to the Bishops curves for further analysis.

Geometry of Grid Layers

It is extremely important to have accurate grid geometry because we are developing detailed results along each layer starting directly behind the facing units to the end of the grid. By calculating the pullout requirements at the end of the grid layer we are determining if a grid layer is embedded enough. Similarly the pullout calculations at the front of the grid layer tells us the required facial stability needed by connection and shear.

For this example we will calculate the pullout of soil from the front and the end of grid 4. The process is the same for all other grid layers as well. We start by dividing the exposed grid length into equal length segments. For this example we will use 25 segments. As explained earlier in the chapter, the more segments modeled the more refined and accurate your results will be.

LEM pullout of soil resistance equation (P):

$$P = \sum \gamma h_{nj} (2 \times C_i \tan \phi) dl$$

where:

- ϕ = Friction angle of the soil above the grid layer
- γ = Unit weight of soil above the grid layer
- h_{nj} = Average height of soil above the n_j grid segment
- $\gamma h_j dl$ = The confining pressure above the n_j grid segment
- C_i = Geogrid interaction coefficient provided by the geogrid manufacturer

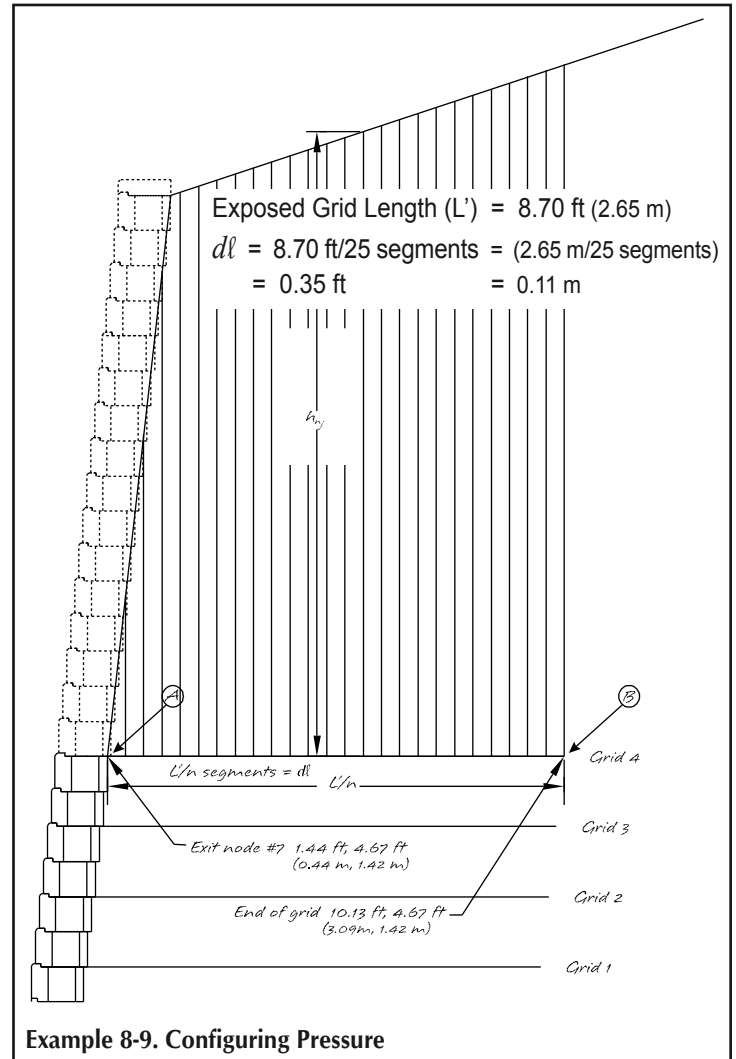

Front Pullout

Running this equation from the front to the back of a grid produces the front end (facial stability) curve. The pullout capacity for the first n-segment is as follows:

$$\begin{aligned} Pr_{A_B1} &= 120 \text{ lb/ft}^3 (1.545 \text{ ft}) (0.348 \text{ ft}) [2 \times 0.7 \times \tan (30^\circ)] = 52.12 \text{ plf} \\ &= 1923 \text{ kg/m}^3 (471 \text{ m}) (0.106 \text{ m}) [2 \times 0.7 \times \tan (30^\circ)] = 761 \text{ kN/m} \end{aligned}$$

Same process for segment 2:

$$\begin{aligned} Pr_{A_B2} &= 120 \text{ lb/ft}^3 (4.636 \text{ ft}) (0.348 \text{ ft}) [2 \times 0.7 \times \tan (30^\circ)] = 156.35 \text{ plf} \\ &= 1923 \text{ kg/m}^3 (9.81 \text{ m/sec}^2) (1.413 \text{ m}) (0.106 \text{ m}) [2 \times 0.7 \times \tan (30^\circ)] = 2,282 \text{ kN/m} \end{aligned}$$

Because the pullout equation is cumulative as the grid layer sees deeper embedment we will add Pr_{A_B1} to Pr_{A_B2} (208.47 plf) (3,043 kN/m). The process continues and is shown in Table 8-7, forming a pullout curve for the front end of the grid layer.

Table 8-7

n	Pr _{A_B} plf (kN/m)	ΣPr _{A_B} plf (kN/m)
1	52.1 (761)	52.1 (761)
2	156.4 (2,282)	208.5 (3,043)
3	260.6 (3,804)	469.1 (6,847)
4	344.0 (5,022)	813.1 (11,870)
5	377.3 (5,508)	1,190.4 (17,378)
6	381.2 (5,565)	1,571.7 (22,944)
7	385.1 (5,622)	1,956.8 (28,566)
8	389.0 (5,679)	2,345.8 (34,245)
9	392.9 (5,736)	2,738.7 (39,982)
10	396.8 (5,793)	3,135.6 (45,775)
11	400.7 (5,850)	3,536.3 (51,625)
12	404.6 (5,907)	3,940.9 (57,532)
13	408.7 (5,966)	4,349.6 (63,498)
14	412.4 (6,021)	4,762.0 (69,519)
15	416.3 (6,078)	5,178.4 (75,597)
16	420.2 (6,135)	5,598.6 (81,732)
17	424.1 (6,192)	6,022.8 (87,923)
18	428.1 (6,249)	6,450.8 (94,172)
19	432.0 (6,306)	6,882.8 (100,478)
20	435.9 (6,363)	7,318.6 (106,841)
21	439.8 (6,420)	7,758.4 (113,261)
22	443.7 (6,477)	8,202.0 (119,737)
23	447.6 (6,534)	8,649.6 (126,271)
24	451.5 (6,591)	9,101.0 (132,861)
25	455.4 (6,648)	9,556.4 (139,509)

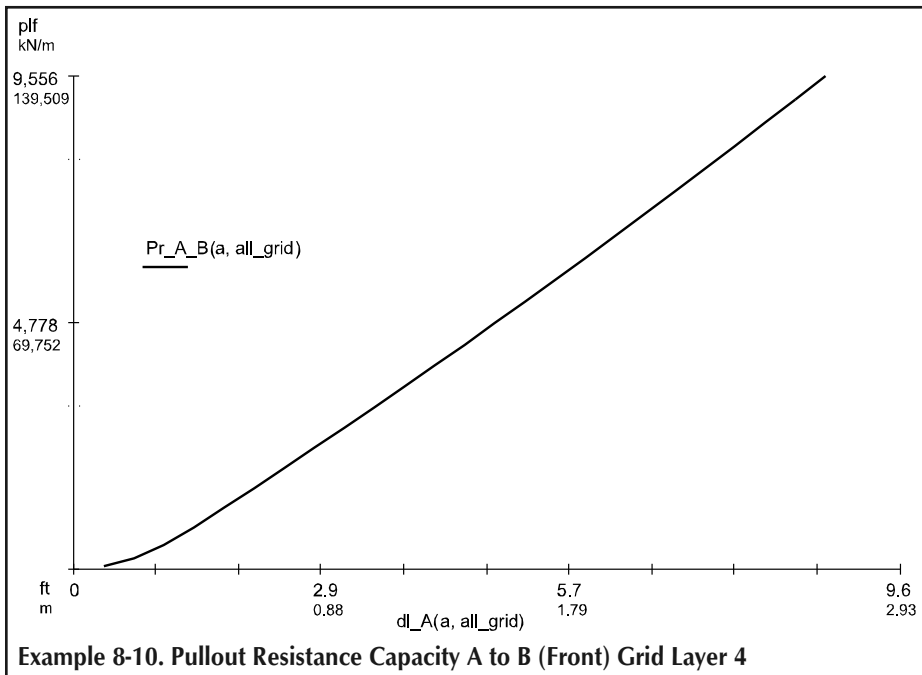

End Pullout

The exact same process is followed to develop the end to front (pullout of soil) curve. However, since the confining pressure is greater at the end as opposed to the front, due to wall geometry, the end will start with a higher capacity and will increase at a slightly faster rate than the front end curve.

$$PrB_{A1} = 120 \text{ lb/ft}^3 (13.501 \text{ ft}) (0.348 \text{ ft}) [2 \times 0.7 \times \tan(30^\circ)] = 455.36 \text{ plf}$$

$$= 1,923 \text{ kg/m}^3 (9.81 \text{ m/sec}^2) (4.1 \text{ m}) (0.106 \text{ m}) [2 \times 0.7 \times \tan(30^\circ)] = 6,648 \text{ kN/m}$$

Same process for segment 2:

$$PrB_{A2} = 120 \text{ lb/ft}^3 (13.385 \text{ ft}) (0.348 \text{ ft}) [2 \times 0.7 \times \tan(30^\circ)] = 451.45 \text{ plf}$$

$$= PrB_{A1} + PrB_{A2}$$

$$= 906.81 \text{ plf}$$

$$PrB_{A2} = 1,923 \text{ kg/m}^3 (9.81 \text{ m/sec}^2) (4.08 \text{ m}) (0.106 \text{ m}) [2 \times 0.7 \times \tan(30^\circ)]$$

$$= PrB_{A1} + PrB_{A2}$$

$$= 13,238 \text{ N/m}$$

Continuing to sum the individual segments will result in a pullout curve at the end of the grid layer as shown in Table 8-8 and Figure 8-11.

Table 8-8

n	Pr_A_B plf (kN/m)	ΣPr_A_B plf (kN/m)
1	455.4 (6,648)	455.4 (6,648)
2	451.5 (6,591)	906.8 (13,238)
3	447.6 (6,534)	1,354.4 (19,772)
4	443.7 (6,477)	1,798.0 (26,248)
5	439.8 (6,420)	2,237.8 (32,668)
6	435.9 (6,363)	2,673.6 (39,031)
7	432.0 (6,306)	3,105.6 (45,337)
8	428.1 (6,249)	3,533.6 (51,586)
9	424.1 (6,192)	3,957.8 (57,777)
10	420.2 (6,135)	4,378.0 (63,912)
11	416.3 (6,078)	4,794.3 (69,990)
12	412.4 (6,021)	5,206.8 (76,011)
13	408.5 (5,964)	5,615.3 (81,975)
14	404.6 (5,907)	6,020.0 (87,882)
15	400.7 (5,850)	6,420.7 (93,733)
16	396.8 (5,793)	6,817.5 (99,526)
17	392.9 (5,736)	7,210.4 (10,5262)
18	389.0 (5,679)	7,599.5 (110,941)
19	385.1 (5,622)	7,984.6 (116,564)
20	381.2 (5,565)	8,365.8 (122,129)
21	377.3 (5,508)	8,743.2 (127,637)
22	344.0 (5,022)	9,087.2 (132,660)
23	260.6 (3,804)	9,347.8 (136,464)
24	156.4 (2,282)	9,504.1 (138,746)
25	52.1 (761)	9,556.3 (139,507)

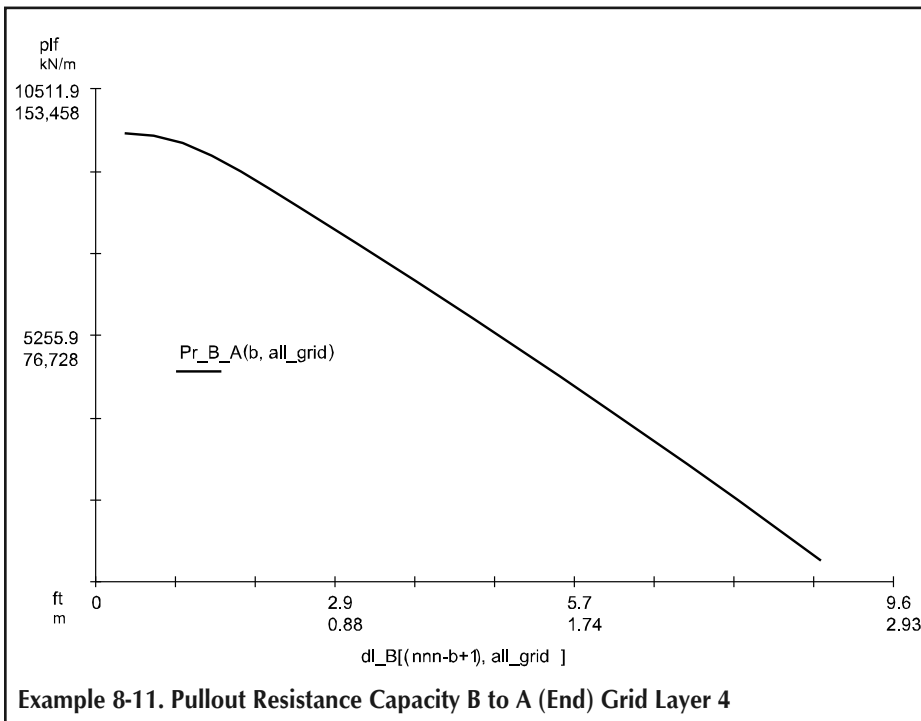

External Surcharges

This example was produced with no additional external surcharges. However, surcharge loads can add to wedge weight which will increase the vertical confining pressure. An increase in the vertical confining pressure will increase the pullout forces and steepen the slope of both front and tail end pullout curves.

Unlike adding the surcharge directly to the wedge weight, like we do in the Bishops calculations, in the soil pullout calculations we translate and dissipate the surcharge through the soil down to the particular grid layer being analyzed. The free body diagram (Example 8-12) can be used to model an external surcharge.

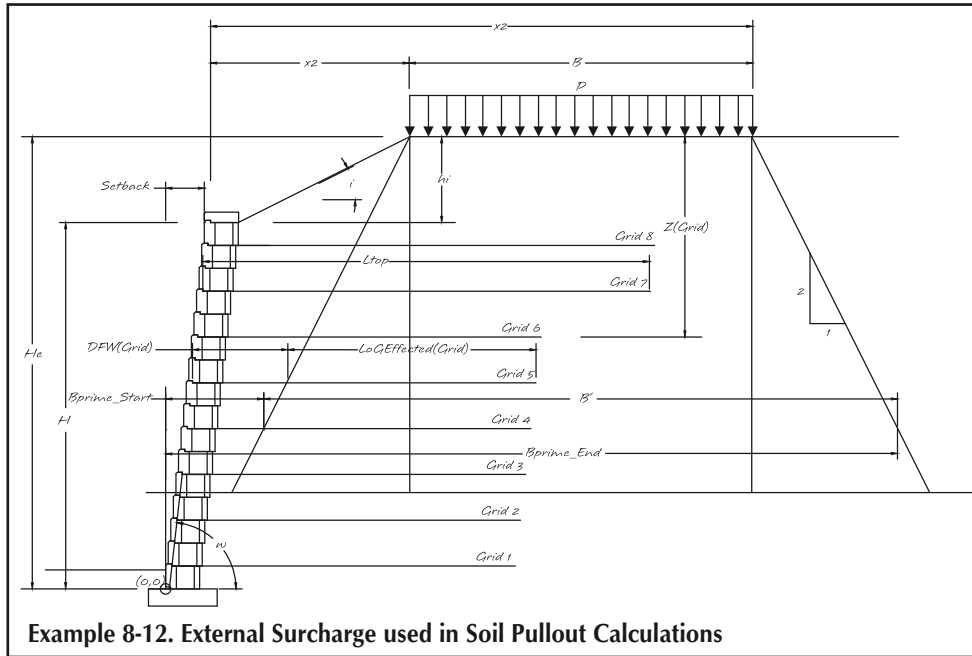

Compare Bishops T_{req} Load results to Soil Pullout Results

We analyzed the calculations for one randomly chosen arc from entrance node 8 to exit node 2. We determined the T_{req} for the selected arc to be 355 lb/ft (5,182 kN/m). By using a computer modeling program additional T_{req} results can be found. The following graph represents six additional T_{req} values and their position along grid 4.

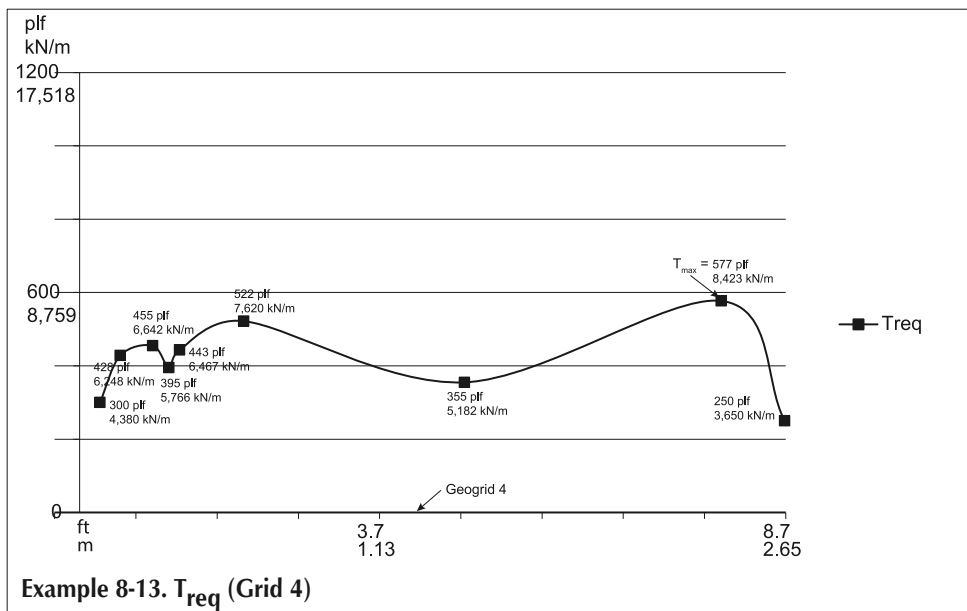

Once the entire T_{req} curve is created by analyzing all 9700 slip arcs, there will be one isolated point along the curve that is greater than all the others. This point is T_{max} and will be used to determine the minimum required grid strength for that particular grid layer.

Determine Minimum Facial Stability and Geogrid Soil Pullout Requirements

Now that we have both the T_{req} and soil pullout envelopes created, we can determine the minimum facial stability and soil pullout requirements by comparing the two.

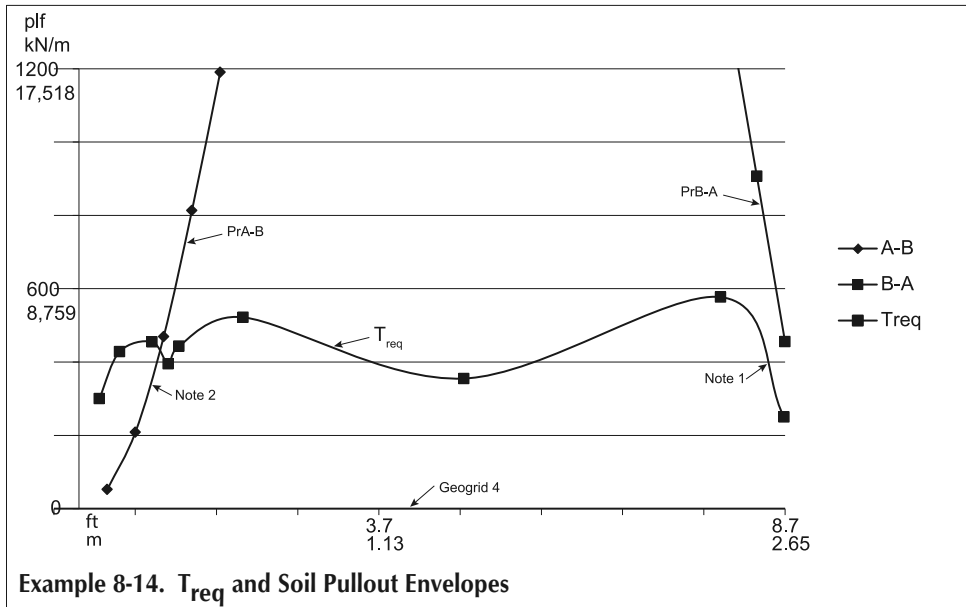

Note 1: The resulting end of grid curves shows the PrB_A curve exceeding the T_{req} curve. Therefore, no additional grid embedment is required. If T_{req} exceeded the PrB_A curve additional grid length would be required.

Note 2: The resulting front curves show the T_{req} curve exceeding the PrA_B curve. When this happens at the front it means that a resisting force is required from the facing in the form of connection strength and block shear strength. If the PrA_B curve exceeded the T_{req} curve, as seen at the end, no additional facial stability resistance would be needed.

Facial Stability

As discussed earlier in the chapter, if the PrA_B curve does not exceed the T_{req} curve it must be translated upwards to the point where it does exceed the T_{req} curve. That translation becomes the minimum connection (T_O) and shear (T_{shear}) requirements required by the facing.

The process to determine the exact T_O and T_{shear} is best done by computer modeling. However, by manually analyzing the T_{req} and PrA_B values at a relatively similar point, you can mathematically determine T_O and T_{shear} .

By comparing points on each curve, 428 plf – 110 plf, provides a T_O of 318 plf (6,248 kN/m – 1,606 kN/m, provides a T_O of 4,642 kN/m).

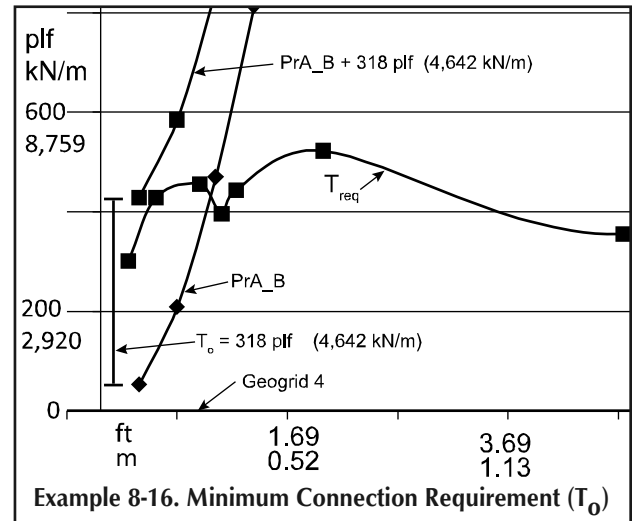
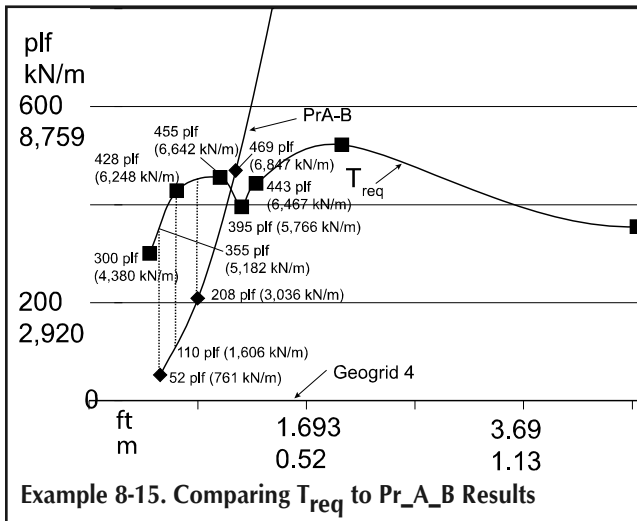

Determine Minimum Block Shear (T_{shear}) Required

Once the minimum connection requirement (T_O) has been determined for each course of grid we can translate our understanding of T_O into facial shear (T_{shear}). For courses with grid, we simply set T_O equal to T_{shear} . For non-grid courses we will sum the T_O values from the grid above and below and average them. This is a reasonable approach to block shear because the tested shear capacity is greater than the tested connection capacity.

Determine Strength of Grid Required for Construction

Our LEM analysis has given us the minimum required grid strength (T_{max}), connection (T_O), and block shear (T_{shear}) for grid 4.

$$T_{max4} = 577 \text{ plf (8,423 kN/m)}$$

$$T_O = 318 \text{ plf (4,642 kN/m)}$$

$$T_{shear4} = 318 \text{ plf (4,642 kN/m)}$$

Traditionally, internal design requires a safety factor of 1.5 and all components. Therefore, the designer must choose a grid and block combination that has the following minimum properties:

$$LTADS = 1.5 (577 \text{ plf}) = 866 \text{ plf} \quad (1.5 (8,423 \text{ kN/m}) = 12,642 \text{ kN/m})$$

$$T_O = 1.5 (318 \text{ plf}) = 477 \text{ plf} \quad (1.5 (4,642 \text{ kN/m}) = 6,964 \text{ kN/m})$$

$$L_{shear} = 1.5 (318 \text{ plf}) = 477 \text{ plf} \quad (1.5 (4,642 \text{ kN/m}) = 6,964 \text{ kN/m})$$



**ALLAN
BLOCK**

allanblock.com

APPENDIX A

AB Engineering Manual Variables

A_0	Specified horiz. peak ground acceleration, pg 44	F_e	Preloaded value of installed earth anchor, pg 14
Alpha	the angle or slope at the bottom of each soil wedge	F_g	Force applied to geogrid, pg 22
Alpha_grid	the angle between the slip arc and the intersecting grid layer	F_{gr}	Maximum potential restraining force of geogrid, pg 26
B_b	Width of the foundation, pg 21	F_h	Horizontal component of active force, pg 10
BB	Block to block shear test configuration, pg 85	F_{id}	Dynamic internal force on geogrid, pg 54
BGB	Block-grid-block shear test configuration, pg 85	F_{pa}	Pullout grid capacity, pg 14
c	Cohesion of foundation soils, pg 21	F_{qh}	Horizontal compaction of surcharge force at the wall, pg 30
C_f	Coefficient of friction, pg 10	F_{qv}	Vertical component of surcharge force at the wall, pg 30
C_i	Coefficient of interaction between the soil and the geogrid, a measure of the ability of the soil to hold the geogrid when a force is applied to it, pg 26	F_r	Maximum frictional resistance (the force that resists sliding of the wall because of friction and the soil), pg 10, 64
D	Depth of wall embedment = buried block + footing thickness, pg 21	F_s	Sliding forces along a particular slip arc, pg 64
d	Allowable lateral deflection that a retaining wall can be designed to withstand during a seismic event, pg 44	$FS_{overstress}$	Geogrid overstress factor of safety, pg 55
d_b	Footing thickness, pg 21	$FS_{pullout}$	Factor of Safety for Geogrid Pullout from the Soil, pg 26
d_1	Distance from the top of the backfill or H_{ei} to the bottom of the zone supported by the layer of geogrid, pg 22	F_v	Vertical component of active force, pg 10
d_2	Distance from the top of the backfill or H_{ei} to the top of the zone supported by the layer of geogrid, pg 22	F_{vb}	The resultant vertical resisting force exerted on the wall by the soil, pg 19
DF_{dyn_i}	Dynamic earth force increment, pg 46	F_w	Force on the geogrid at the back face of the wall, pg 25
d_g	Depth from the top of the infill or H_{ei} to the layer of geogrid, pg 26	F_{we}	Weighted design value of anchor, pg 14
d_h	Difference between d_1 and d_2 , pg 22	H	Distance from the bottom of the wall to the top of the wall (Depth from the top of the retained soil mass), pg 5
D_{sj}	Cohesion in LEM, pg 88	H'	Height from exit node to top of wall (height of column), pg 89
e	Eccentricity of the resultant vertical force; the distance from the centerline of bearing of the gravity wall to the point of application of the resultant force, pg 19	H_e	Effective wall height of a coherent gravity wall for external calculations, pg 39
F_a	Active force on retaining wall; resultant force of the active pressure on the retaining wall, pg 5	H_{ei}	Effective wall height of a coherent gravity wall for internal calculations, pg 41
F_{ae}	Magnitude of dynamic earth force, pg 46	hg	Average height of soil above a particular geogrid layer, defining the confining pressure above the grid layer, pg 87
F_{bg}	Force between grids, pg 89	H_{ir}	Moment arm associated with the seismic inertial force, pg 52
F_{cs}	Peak connection strength, pg 24	H_q	Height of the wall affected by the surcharge, pg 29
		H_Q	Height of point load, pg 34

AB Engineering Manual Variables

h_{VC}	Distance up to the geometric vertical center of the slope above, pg 41	P	Soil pullout envelope, pg 87
i	Slope of the top of the retained soil, pg 5	P_a	Active earth force on retaining wall calculated by trial wedge method, pg 58
K	Pressure coefficient, pg 5	P_{ae}	Active earth force including dynamic forces calculated by trial wedge method, pg 58
K_a	Active pressure coefficient, pg 5	P_{avg}	Average soil pressure on the wall section, pg 22
K_{ae}	Dynamic earth pressure coefficient, pg 43	P_{front}	The minimum pullout requirement from the connection end of a geogrid layer, pg 86
K_{ae_i}	Dynamic earth pressure coefficient for the infill soil, pg 45	P_h	The earth pressure at the base of the wall, pg 6
K_{ae_r}	Dynamic earth pressure coefficient for the retained soil, pg 46	P_{ir}	Seismic inertial force, pg 51
K_{ai}	Active earth pressure coefficient infill, pg 16	P_q	The pressure due to a surcharge, pg 29
K_{ar}	Active earth pressure coefficient retained, pg 16	P_{end}	The minimum pullout requirement from the soil pullout end of a geogrid layer, pg 86
K_h	Horizontal seismic acceleration coefficient, pg 43	P_v	The vertical pressure at any given depth, pg 6
K_o	At rest earth pressure coefficient, pg 5	q	Surcharge, pg 28
K_v	Vertical seismic acceleration coefficient, pg 43	q_f	Ultimate bearing capacity, pg 21
l	Width of the section, pg 20	Q	Horizontal component of the surcharge force, pg 32
L'	Length of exposed geogrid layer behind the block facing, pg 86	RF_{cr}	Reduction factor applied to geogrid for long term creep, pg 55
L_a	Length of geogrid in the active zone, pg 27	S	Section modulus of a 1 ft (0.3 m) wide section of the wall, pg 20
L_e	Length of geogrid embedded in the passive zone of the soil, pg 26	S_{block}	Block shear component, pg 85
L_{e_d}	Length of geogrid embedded in the passive zone of the soil under dynamic loading, pg 55	SFB	Bearing factor of safety, pg 21
L_s	Equivalent lip thickness, pg 16	SF_{conn}	Factor of Safety for the Static Geogrid/Block connection capacity, pg 24
L_t	Total length of geogrid required per linear foot of wall, pg 16	SF_{mech}	Mechanical connection factor of safety, pg 23
$LTADS$	Long term allowable design strength of geogrid reinforcement, pg 14, 23	SFO	Safety factor against overturning, pg 11
L_w	Length of geogrid inside the Allan Block unit, pg 27	SFS	Safety factor against sliding, pg 10
M_B	Bearing capacity moment due to the eccentricity of the resultant vertical force, pg 20	t	Depth of block, pg 7
M_α	Relationship between the strength of the soil and the relative angle of slip, pg 85	$\tan(\phi)$	The coefficient of friction (shear strength) between adjacent layers of soil, pg 10, 26
M_o	Moments causing overturning, pg 11	T_{max}	the maximum tensile force within a particular geogrid layer, pg 82
M_r	Moments resisting overturning, pg 11	T_o	The minimum required connection resistance, pg 82
N	Normal load from the weight of facing above grid location, pg 24	T_{req}	the minimum tensile force at a particular spot along the length of a geogrid layer, pg 81
N_g	Number of geogrid layers, pg 54	T_u	Ultimate pullout resistance capacity, pg 82
N_q, N_c, N_γ	Terzaghi/Meyerhof equations from Craig p. 303, Soil Mechanics, Fifth Edition, pg 21	U_j	Water pressure in LEM, pg 88
		V_c	Volume of concrete for each Allan Block unit, pg 7

AB Engineering Manual Variables

V_t	Total vertical force, pg 12	σ_{mom}	Difference in stress due to eccentricity, pg 20
V_{tot}	The total volume occupied by each standard Allan Block unit, including voids, pg 7	σ_v	Vertical stress on soil at a given depth, pg 5
V_v	The volume of voids (difference of V_{tot} and V_c) for each Allan Block unit, pg 7	ϕ	Friction angle of soil, pg 1, 5
W	Width of column in F_{bg} equation, pg 89	ϕ_B	Internal friction angle for base material, pg 21
WA	Weight of soil in the active wedge, pg 54	ϕ_f	Friction angle of foundation soils, pg 21
W_f	Weight per linear foot of wall facing, pg 8	ϕ_i	Friction angle of infill soils, pg 16
W_j	Weight of the triangular section of the sloped backfill, pg 51	$\phi_{i_1, 2, 3}$	Friction angle of infill soils in the multiple soils section, pg 62
W_j	The weight of a particular soil wedge along the defined slip arc, pg 83	ϕ_r	Friction angle of retained soils, pg 62
W_s	Weight of the reinforced soil mass, pg 17	$\phi_{r_1, 2, 3}$	Friction angle of retained soils in the multiple soils section, pg 16
W_s'	Weight of soil mass based on a reinforced depth of 0.5 H, pg 52	ϕ_w	Angle between a line perpendicular to the wall face and the line of action of the active force, pg 5
W_w	Total weight of coherent gravity wall, pg 17		
X	The point of application of the resultant bearing capacity force, pg 19		
X_L	The distance from the front of the top AB unit to the uniform surcharge, pg 29		
Y_1	Moment of arm of the horizontal component of the active force, = H/3, pg 11		
α_{grid}	Intersection angle between grid and slip arc, pg 86		
α_i	Angle of inclination of the Coulomb failure surface, pg 55		
β	Angle between horizontal and the sloped back face of the wall, pg 5		
γ	Unit weight of soil, pg 5		
γ_i	The unit weight of the infill soil, pg 16		
$\gamma_{i_1, 2, 3}$	Unit weight of the infill soils in the multiple soils section, pg 62		
γ_r	Unit weight of retained soil, pg 16		
$\gamma_{r_1, 2, 3}$	Unit weight of the retained soils in the multiple soils section, pg 62		
γ_{wall}	Unit weight of the wall facing, pg 7		
θ	Seismic inertia angle, pg 43		
σ_{avg}	Average bearing pressure, pg 19		
σ_h	Horizontal stress on retaining wall, pg 5		
σ_{max}	Maximum bearing pressure, pg 20		
σ_{min}	Minimum bearing pressure, pg 20		

Complex Composite Structure Variables

Many of the variables listed above are redefined in Chapter 7 for CCS Designs. There will be a "top" or "bot" designation to represent the variable for the Upper or Lower structure respectively.

APPENDIX B

Allan Block Connection Tests and Shear Testing

Internal Compound Stability (ICS) allows you to consider the wall facing of the reinforced soil structure as part of the analysis. This is important to remember because the Allan Block units provide shear connection at the face and geogrid connection capacities that make a substantial difference in the stability of the wall. However, we need to understand just how the wall facing components work. The following tech sheet provides the basic understanding and Allan Block results of the two most widely used tests in the design of Segmental Retaining Walls (SRW's), SRW-1 and SRW-2. The specific test procedures are described in ASTM D6638 and D6916, respectively.

SRW-1 (ASTM D6638) Connection Testing

Allan Block has always been a leader in the SRW industry by thoroughly testing our products to the highest of industry standards. SRW-1 determines the grid pull-out capacities or connection strength of a block to the geogrid reinforcement. Allan Block's patented "Rock-Lock connection" provides a continuous positive interlocking of the geogrid to the aggregate filled cores of the Allan Block unit (See Figure 1). Allan Block has performed SRW-1 at the University of Wisconsin – Platteville, Bathurst Clarabut Geotechnical Testing (BCGT), and the National Concrete Masonry Association (NCMA) test facilities among others on many different grid families. The results in Figure B-2 are for Huesker's Fortrac 35. The strength of the Rock-Lock connection allows the connection strength to well exceed the Long Term Allowable Design Strength (LTADS) as the normal loads increase. In fact, the lower strength grids perform so efficiently with the Rock-Lock connection that the ultimate connection strength nearly reaches the grids LTADS at the lowest applied normal load or the y-intercept. For these and other test summaries please contact the Allan Block Engineering Department.

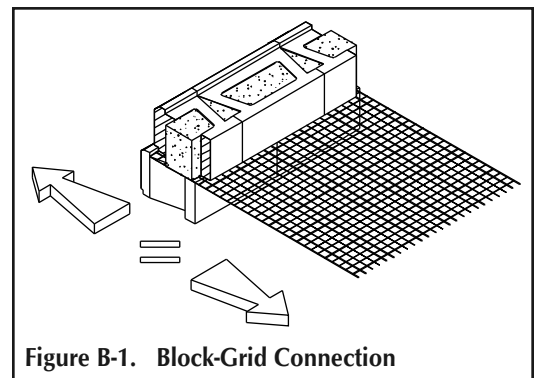

Figure B-1. Block-Grid Connection

Fortrac 35

Design Equations

Ultimate Connection Strength

Segment 1

$$T_u = 1,313 \text{ lb/ft} + \tan(8^\circ)$$

$$T_u = 19.16 \text{ kN/m} + \tan(8^\circ)$$

Maximum
= 1,686 lb/ft (24.6 kN/m)

Long Term Allowable Design Strength

LTADS
= 1,322 lb/ft (19.3 kN/m)

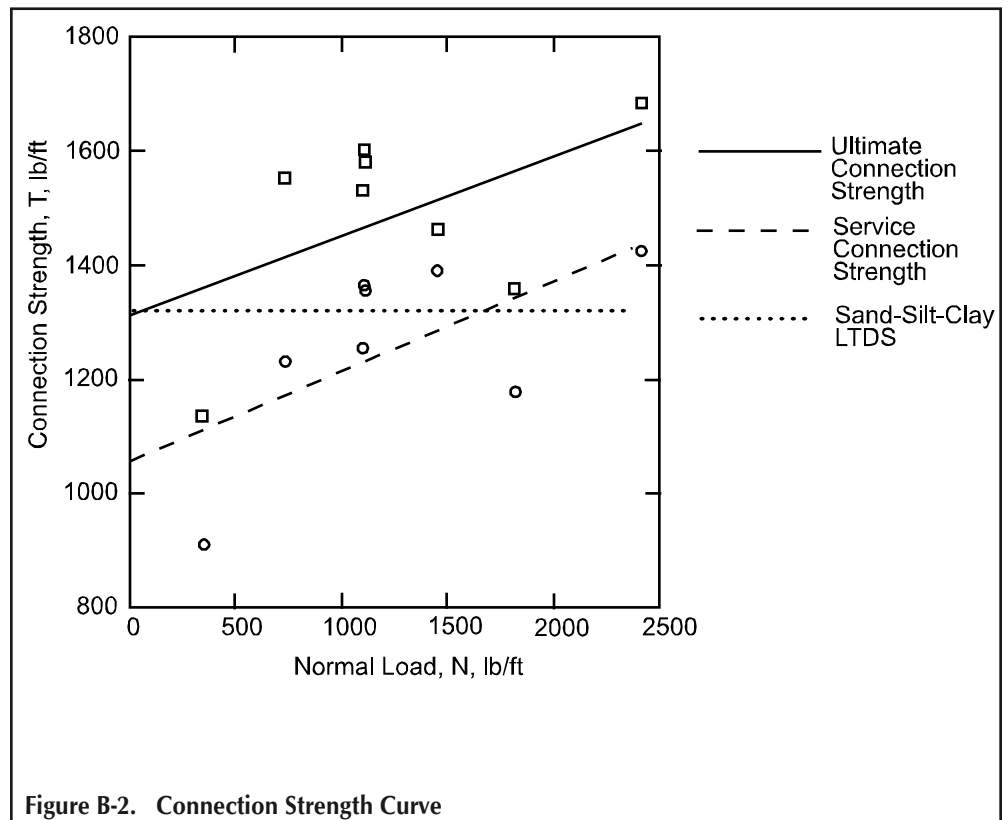

Figure B-2. Connection Strength Curve

SRW-2 (ASTM D6916) Interface Shear Strength

Shear testing has been commonly used to determine the effective internal shear resistance of one course of block relative to the next. Figure B-3 shows the three pieces that together make up the total resistance, Shear Key (Upper Lip), Block-to-Block Friction and the aggregate Rock Lock. Testing was performed on AB Stones and AB Classic (2 inch lipped product (50 m)), AB Vertical (1 1/2 in. lipped product (40 mm)) and AB Rocks. The AB Rocks units, because of their larger shear lip, tested so well they did not shear under test conditions. The shear equations are shown in Figure 4. Testing with a layer of geogrid between courses is designed to be a worst-case condition as the grid acts as a slip surface reducing the contributions from Block Friction and aggregate Rock Lock. In the case of AB Stones and AB Classic the results were so great with the grid layer in place that a block-to-block test was not run.

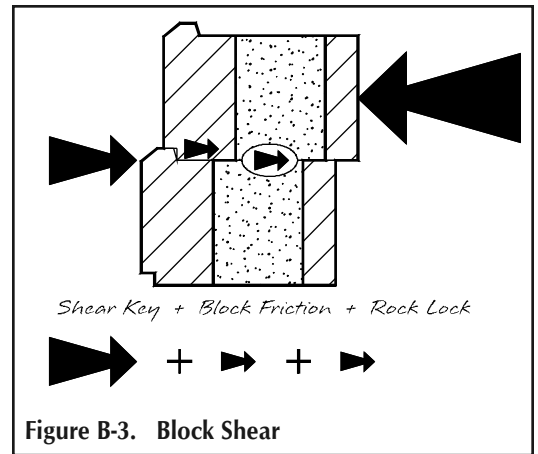

Figure B-3. Block Shear

Localized Wall Stability

New design theories such as ICS are recognizing the added benefit of a high shear and grid connection between layers of stackable block when analyzing wall stability. Careful analysis reveals that in order for geogrid to be dislodged from its position between two blocks, one of two things must happen. Either the entire wall facing must rotate forward or there must be relative movement between block courses.

The relative movement between block courses in an SRW wall can be defined as the localized wall stability. In the event that an ICS slip plane is formed through the reinforced mass (Figure B-5) the grid connection and block shear will act together to resist the sliding forces. However, at some point one or the other will become the lesser and thus be the controlling factor in the wall stability. Consider a wall with single course grid spacing from bottom to top. This wall is more likely to have Shear control the localized stability than connection because the wall is ultimately as "rigid" as possible due to the continuous grid interaction. Now consider this same wall with 4 course grid spacing. It is intuitive that the wall is less "rigid" and thus more capable of bulging. In this case the shear capacity would well exceed the connection contribution from the few grid layers surrounding the slip surface and thus connection would be the lesser controlling factor.

Once a wall reinforced with geogrid has been properly constructed with well compacted soils and proper length and spaced geogrids, the reinforced mass works as a solid unit or coherent gravity mass. Therefore, in a competent coherent gravity mass and ICS slip plane will not occur and the actual stresses at the back of the facing will be minimal.

Competitive Advantage

The raised front shear lip and granular infill in an Allan Block Wall provides a better engineering solution than the pin type interlock systems offered by many other retaining wall systems. Understanding this concept and you will understand why Allan Block retaining walls perform better than the competition.

2 in. (50 mm) Lip w/ Geogrid Layer	$V_u = 2,671 \text{ lb/ft} + N \tan(38^\circ)$ $= 38.9 \text{ kN/m} + N \tan(38^\circ)$
1 1/2 in. (40 mm) Lip	$V_u = 1,018 \text{ lb/ft} + N \tan(61^\circ)$ $= 14.8 \text{ kN/m} + N \tan(61^\circ)$
1 1/2 in. (40 mm) Lip w/ Geogrid Layer	$V_{u1} = 743 \text{ lb/ft} + N \tan(71^\circ)$ $= 10.8 \text{ kN/m} + N \tan(71^\circ)$ $V_{u2} = 3,780 \text{ lb/ft}$ $= 55.1 \text{ kN/m}$

Figure B-4. Shear Test Results

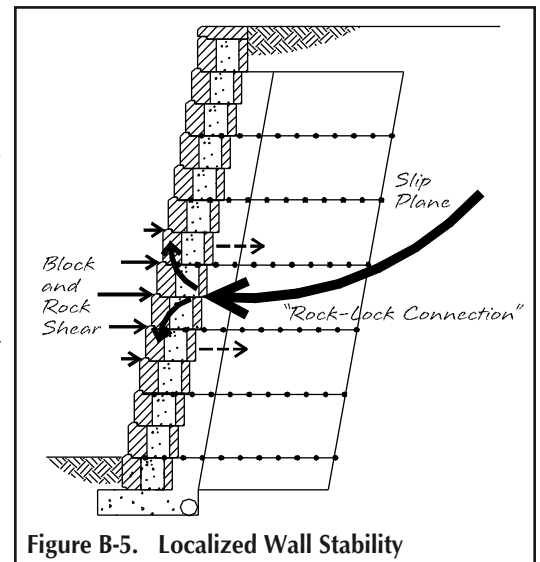

Figure B-5. Localized Wall Stability

GEOGRID SPECIFICATIONS AND CONNECTION TESTING RESULTS FOR:

AB Full-Size Units							
Geogrid Type	Long Term Allowable Design Strength, LTDS, lb/ft (kN/m)			Reduction Factor Creep, RFcr	Peak Connection Strength Equations, P, lb/ft (kN/m)		Normal Load Intercept lb/ft (kN/m)
	Sand-Silt-Clay	Sand-Gravel	Gravel		Segment 1	Segment 2	
Strata Systems, 380 Dahlonega Road, Cummings, GA 30040 800-680-7750							
Strata SGU 60	2343 (34.4)	2062 (30.1)	1909 (27.8)	1.45	$T_{u1} = 1165 \text{ lb/ft} + N \tan(20.0^\circ)$ ($T_{u1} = 17.0 \text{ kN/m} + N \tan(20.0^\circ)$)	-	-
Strata SGU 80	3125 (45.6)	2750 (40.1)	2546 (37.2)	1.45	$T_{u1} = 1235 \text{ lb/ft} + N \tan(24.0^\circ)$ ($T_{u1} = 18.02 \text{ kN/m} + N \tan(24.0^\circ)$)	-	-
Strata SGU 120	4686 (68.4)	4686 (68.4)	4482 (65.4)	1.45	$T_{u1} = 1340 \text{ lb/ft} + N \tan(33.0^\circ)$ ($T_{u1} = 19.56 \text{ kN/m} + N \tan(33.0^\circ)$)	-	-
Tencate Nicolon, 365 South Holland Drive, Pendergrass, GA 30567 888-795-0808							
Miragrid 2XT	1142 (16.60)	1090 (15.90)	960 (14.0)	1.45	$T_{u1} = 125.60 \text{ lb/ft} + N \tan(58.48^\circ)$ ($T_{u1} = 1.80 \text{ kN/m} + N \tan(58.48^\circ)$)	$T_{u2} = 1623.5 \text{ lb/ft}$ ($T_{u2} = 23.65 \text{ kN/m}$)	918.6 (13.40)
Miragrid 3XT	1999 (29.10)	1908 (27.70)	1676 (24.40)	1.45	$T_{u1} = 1193 \text{ lb/ft} + N \tan(29^\circ)$ ($T_{u1} = 17.40 \text{ kN/m} + N \tan(29^\circ)$)	-	-
Miragrid 5XT	2684 (39.0)	2562 (37.30)	2255 (32.80)	1.45	$T_{u1} = 1287 \text{ lb/ft} + N \tan(29^\circ)$ ($T_{u1} = 14.30 \text{ kN/m} + N \tan(29^\circ)$)	-	-
Miragrid 7XT	3370 (49.10)	3217 (46.90)	2831 (41.20)	1.45	$T_{u1} = 1065.4 \text{ lb/ft} + N \tan(25.62^\circ)$ ($T_{u1} = 15.52 \text{ kN/m} + N \tan(25.62^\circ)$)	-	-
Miragrid 8XT	4226 (61.60)	4034 (58.80)	3550 (51.70)	1.45	$T_{u1} = 1063 \text{ lb/ft} + N \tan(40^\circ)$ ($T_{u1} = 15.51 \text{ kN/m} + N \tan(40^\circ)$)	$T_{u2} = 2872 \text{ lb/ft}$ ($T_{u2} = 41.9 \text{ kN/m}$)	2155.9 (31.45)
Miragrid 10XT	5426 (79.0)	5179 (75.40)	4558 (66.40)	1.45	$T_{u1} = 513 \text{ lb/ft} + N \tan(52^\circ)$ ($T_{u1} = 7.48 \text{ kN/m} + N \tan(52^\circ)$)	$T_{u2} = 1426 \text{ lb/ft} + N \tan(23^\circ)$ ($T_{u2} = 20.81 \text{ kN/m} + N \tan(23^\circ)$)	1067.3 (15.57)
Huesker - 11107 - A South Commerce Blvd, Charlotte, NC 28273 800-942-9418							
Fortrac 35T	1197 (17.4)	1175 (17.0)	1097 (15.9)	1.522	$T_{u1} = 911 \text{ lb/ft} + N \tan(6.8^\circ)$ ($T_{u1} = 13.3 \text{ kN/m} + N \tan(6.8^\circ)$)	-	-
Fortrac 55T	1898 (27.6)	1864 (27.1)	1815 (26.3)	1.522	$T_{u1} = 1070.3 \text{ lb/ft} + N \tan(15.1^\circ)$ ($T_{u1} = 15.62 \text{ kN/m} + N \tan(15.1^\circ)$)	-	-
Fortrac 80T	2979 (43.3)	2950 (42.8)	2813 (40.9)	1.522	$T_{u1} = 1250.7 \text{ lb/ft} + N \tan(18.3^\circ)$ ($T_{u1} = 18.25 \text{ kN/m} + N \tan(18.3^\circ)$)	-	-

AB Fieldstone Units							
Geogrid Type	Long Term Allowable Design Strength, LTDS, lb/ft (kN/m)			Reduction Factor Creep, RFcr	Peak Connection Strength Equations, P, lb/ft (kN/m)		Normal Load Intercept lb/ft (kN/m)
	Sand-Silt-Clay	Sand-Gravel	Gravel		Segment 1	Segment 2	
Strata Systems, 380 Dahlonega Road, Cummings, GA 30040 800-680-7750							
Strata SGU 60	2343 (34.4)	2062 (30.1)	1909 (27.8)	1.45	$T_{u1} = 1165 \text{ lb/ft} + N \tan(20.0^\circ)$ ($T_{u1} = 17.0 \text{ kN/m} + N \tan(20.0^\circ)$)	-	-
Strata SGU 80	3125 (45.6)	2750 (40.1)	2546 (37.2)	1.45	$T_{u1} = 1235 \text{ lb/ft} + N \tan(24.0^\circ)$ ($T_{u1} = 18.02 \text{ kN/m} + N \tan(24.0^\circ)$)	-	-
Strata SGU 120	4686 (68.4)	4686 (68.4)	4482 (65.4)	1.45	$T_{u1} = 1340 \text{ lb/ft} + N \tan(33.0^\circ)$ ($T_{u1} = 19.56 \text{ kN/m} + N \tan(33.0^\circ)$)	-	-
Tencate Nicolon, 365 South Holland Drive, Pendergrass, GA 30567 888-795-0808							
Miragrid 2XT	1142 (16.6)	1090 (15.8)	960 (13.9)	1.45	$T_{u1} = 125.5 \text{ lb/ft} + N \tan(58.5^\circ)$ ($T_{u1} = 1.8 \text{ kN/m} + N \tan(58.5^\circ)$)	$T_{u2} = 1623.5 \text{ lb/ft}$ ($T_{u2} = 23.65 \text{ kN/m}$)	918.0 (13.3)
Miragrid 3XT	1999 (29.0)	1908 (27.7)	1676 (24.4)	1.45	$T_{u1} = 1193 \text{ lb/ft} + N \tan(29^\circ)$ ($T_{u1} = 17.4 \text{ kN/m} + N \tan(29^\circ)$)	-	-
Miragrid 5XT	2684 (39.0)	2562 (37.2)	2255 (32.7)	1.45	$T_{u1} = 1287 \text{ lb/ft} + N \tan(29^\circ)$ ($T_{u1} = 18.7 \text{ kN/m} + N \tan(29^\circ)$)	-	-

The information in this chart has been taken from published literature and is believed to be accurate. Consult the Allan Block Engineering Department for details at 800-899-5309.

Table B-1 Pullout Resistance Equations

APPENDIX C

Designing Balance Into Your Retaining Wall Project

Engineers have the responsibility of designing cost effective structures that are safe and reliable. On the surface this task seems to be relatively straight forward and one that can easily be quantified. The questions that must be answered to achieve this design standard will determine how complicated this process will be.

What forces will be applied to the structure? What materials will be used to build the structure? Are there other elements that may affect the performance of the structure? During the construction process, what safeguards will be in place to ensure that plans and specifications are followed? What will be required after completion of the project for the continued safe, reliable performance of the structure? What has our experience told us about what can go wrong in real life?

These questions have led to a series of changes over the last twenty years in the design of segmental retaining walls. Allan Block has helped to drive the industry to ensure cost effectiveness with safety and reliability. During this time frame many things have evolved, and design refinements are producing a better final product that suits the needs of our customers.

From our field experience and full scale testing we have arrived at conclusions that change how we approach designs. The following design guidelines should be implemented to provide for a safer more reliable structure. This does not imply that the structures built over the last twenty years are not safe, but rather we have determined that with a few simple changes we can build safer yet still efficient retaining wall structures.

1. Compaction. Geogrid-reinforced structures are designed to perform as a composite structure. In order for them to perform in this manner, consistent compaction is mandatory. Actual installations are plagued with improper compaction due to soil lifts in excess of the maximum 8 in. (200 mm) lifts. Tighter specifications should be used on compaction and field testing requirements.

2. Geogrid Spacing. Compound failure planes may develop when the reinforced mass is constructed with geogrids that are not spaced close enough together. Allan Block recommends geogrid spacing of 16 in. (406 mm) or less. This is a more efficient way to distribute the reinforcement throughout the mass, which develops a more coherent structure. Since more layers of grid are installed, lower strength grids may be utilized and not affect the project budget, as long as all safety factors are met.

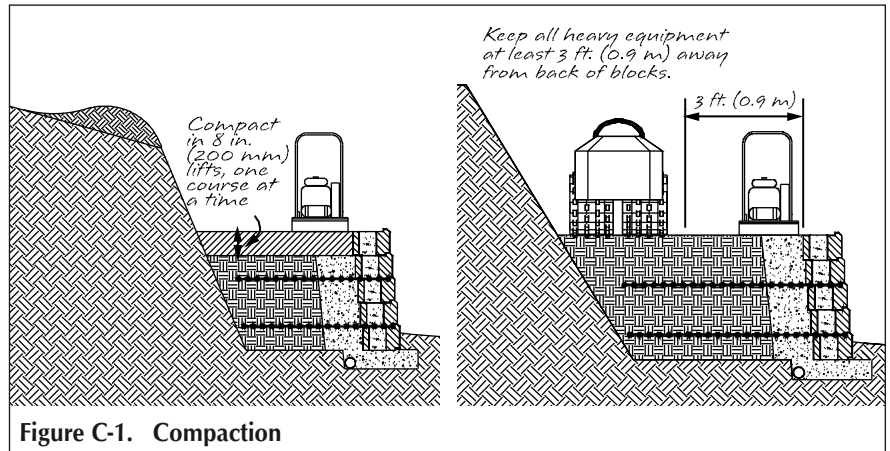

Figure C-1. Compaction

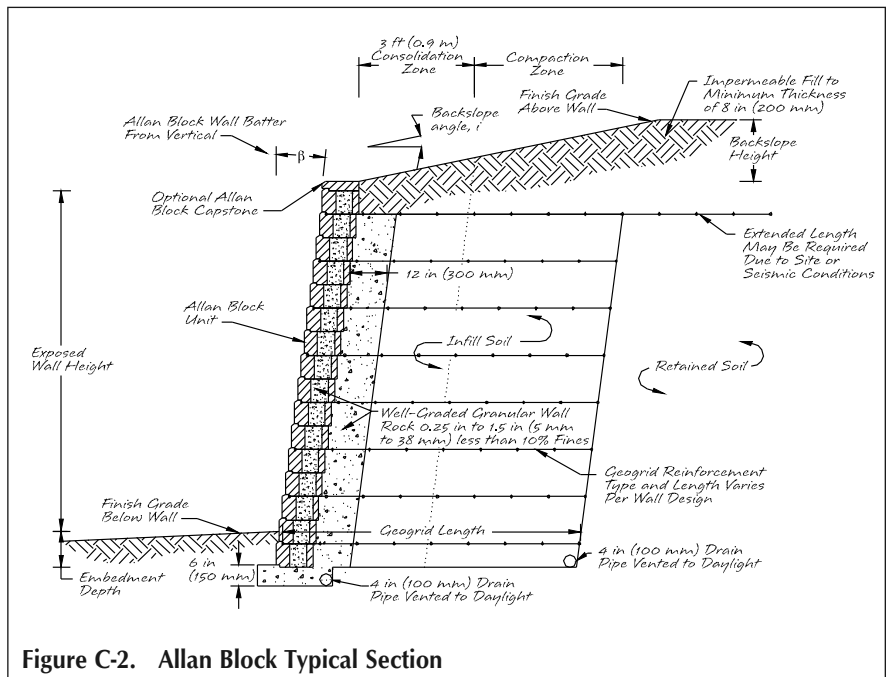

Figure C-2. Allan Block Typical Section

3. Geogrid Length. We have concluded that grid lengths between 50 and 60 percent of the wall height will provide a safe and efficient structure, but for simplicity we are recommending 60 percent as the typical grid length for a starting point. The exception is the top layer of grid which should be extended to intertwine the reinforced mass with the retained soil mass. This eliminates potential for soil cracks at the intersection of these two masses by extending the top grid layers by approximately 3 ft (0.9 m), or to 90% of the wall height to tie the reinforced mass into the retained mass for seismic designs, walls with surcharges, or slopes above the infill mass.

4. Infill Soil. Onsite soils may be used as infill soil if they are of sufficient quality. Stay away from high plastic clays in the reinforced soil mass and use granular material whenever possible. When clay soils are used in the reinforced zone extra precautions should be employed to keep water from penetrating the mass. See Table 1 for the recommended materials for infill soil.

5. Water Management. The addition of water to the reinforced soil mass can change the soil properties dramatically. Designers need to understand and control surface and subsurface water flows. Wall rock and toe drains are intended for incidental water only, any excess surface or subsurface water should be routed away from the reinforced soil mass by using berms, swales and chimney drains.

Table 1: Inorganic USCS Soil Types:

GP, GW, SW, SP, SM meeting the following gradation as determined in accordance with ASTM D422.

Sieve Size	Percent Passing
1 inch (25 mm)	100 - 75
No. 4	100 - 20
No. 40	0 - 60
No. 200	0 - 35

Issues of design and construction will always be an ongoing evolutionary process. To accommodate this Allan Block has and will continue to invest in obtaining data from new experiences and full scale tests. Contact the Allan Block Engineering Department for additional assistance and visit our web site to obtain more information on designing segmental walls.

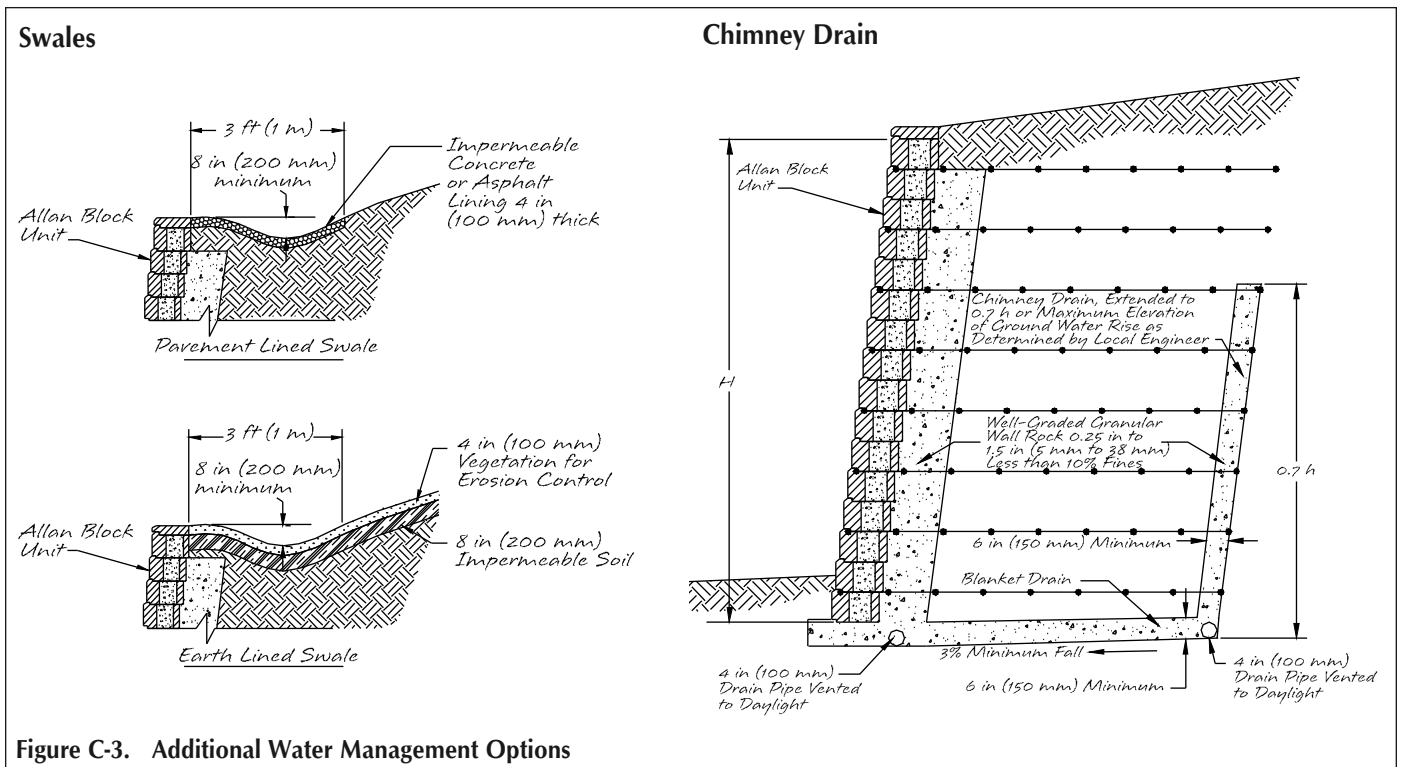

Figure C-3. Additional Water Management Options

** The information provided in this appendix is important for all designers to understand. For a more detailed discussion on design and construction topics see the Best Practices for Segmental Retaining Walls available at allanblock.com

APPENDIX D

Designing with No Fines Concrete in AB Walls Design Software

Allan Block's AB Walls design software is the most comprehensive SRW design software available. Among its many functions and design capabilities is the ability to seamlessly design with No-Fines Concrete (NFC). It is not uncommon to have a site where traditional geogrid reinforced sections will not work. The SRW industry expects to see geogrid lengths equal to at least 60% of the total height of the wall. NFC can typically be used at roughly 30 - 40% of the wall height or less depending on the engineer's understanding of the site. This small percentage difference can, in many cases, solve the space limitation problem. NFC can also be used in complex projects where the wall section has come in contact with bedrock or other obstacles. In many cases it is too costly to remove the bedrock or the obstruction simply cannot be moved. In these cases, NFC is the perfect option. Using the Complex Composite Structure (CCS) function within AB Walls, the engineer can design the lower portion of wall with NFC and the upper portion as a traditional geogrid reinforced section. AB Walls and the CCS functions allow the designer to do these and more with NFC.

The following information is meant to be a User-Guide to using NFC within AB Walls. See Tech Sheet #417 on Building with No Fines Concrete for an in depth discussion on the uses and construction techniques of NFC on allanblock.com.

AB Walls NFC options

Users of AB Walls can design multiple cross sections along a wall's length and more importantly, they can have each cross section have its own characteristics depending on site constraints or surcharge loading. One section could be a traditional geogrid application and the next could be a NFC or even a Complex Composite Structure (CCS). AB Walls provides the flexibility the designer needs to create a compressive design for their most complicated sites.

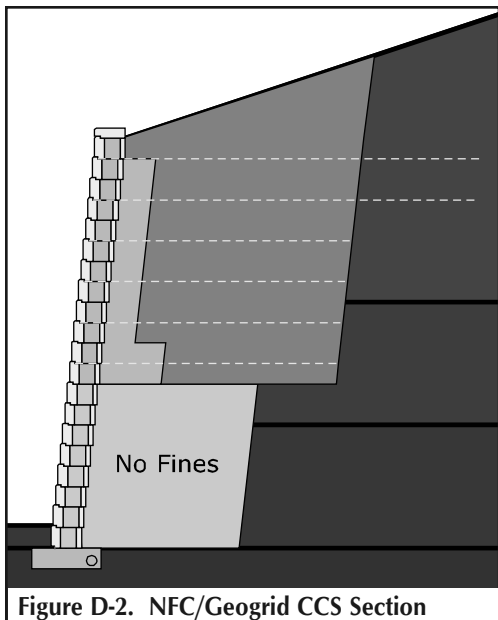

Figure D-2. NFC/Geogrid CCS Section

To start a design in AB Walls Design Software, the designer must choose a wall block and a geogrid even if the entire wall is to be NFC. Then simply move through the Elevation, Plan and Panels screens as normal. These three screens allow the designer to input the geometry of the wall profile and plan view, and the ability to choose the individual wall lengths (called Panels) to create a design cross section for. As stated above, each panel section can be independent of the others. Once the designer accesses the cross section design screen, then click the "Design Parameters" button in the lower left corner of the screen and then click the "Design Options" tab on the following screen to access the NFC info. In the Design Options screen the designer can choose a variety of alternate design methods such as

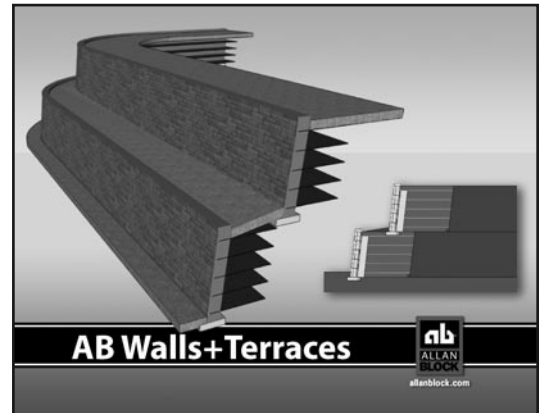

Figure D-1. No Fines Concrete Section

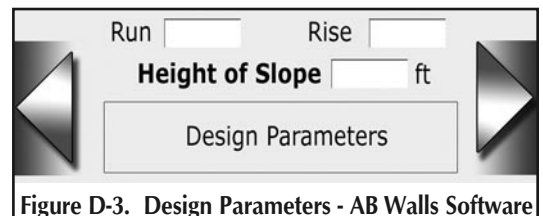

Figure D-3. Design Parameters - AB Walls Software

double block facing, NFC, they can manually input a desired Base size or set an alternate CCS bottom to top ratio. To use NFC, simply click “Yes” to the “Design with NFC” question. Notice the default depth ratio sets to 40%. AB Walls is a design tool and does not mandate the designer do their designs only one way. The designer has a choice of other percentages or they can manually enter a desired structure depth by percentage or by distance. They can also view a copy of the NFC shear test report completed by an independent testing lab. The test will be discussed later in this tech sheet. Once the designer has chosen NFC, simply click the Hide button and design the NFC section by clicking the “Calculate” button back on the design screen. Because this NFC section is now considered a deeper gravity wall, the only safety factors to be concerned with are the external sliding and overturning. Internal analysis may be accomplished using Internal Compound Stability (ICS). A detailed discussion of ICS calculations can be found in the ICS Tech Sheet as well as how it functions in NFC and CCS structures later in this tech sheet. AB Walls will tell the designer if the external safety factors are too low. Deepening the mass will increase the safety factor. To check ICS, click the “Calculate ICS” button and run the check. Again, if the safety factors are low, deepening the mass will increase them.

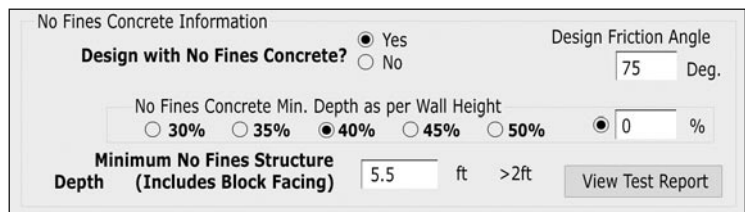

Figure D-4. NFC Functions - AB Walls Software

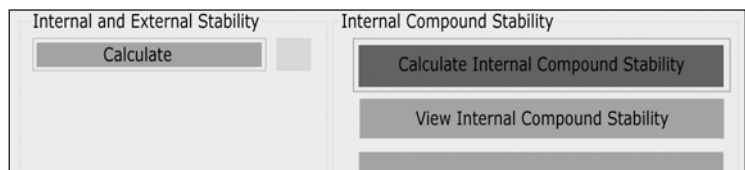

Figure D-5. Calculate Functions - AB Walls Software

Specifics on How NFC is used in a Traditional SRW Design External

The first calculations any designer does for an SRW project are the external calculations. They are by far the easiest to perform. For External Calculations (Sliding and Overturning) you simply compare the eccentricity of the overall weight and depth of the wall to the active earth pressure forces acting at the back of the wall. When the designer uses NFC in and behind the facing they are increasing the facing weight and depth and thus the resistance to the Sliding and Overturning forces. The deeper the NFC mass, the heavier and deeper the mass gets and thus the taller the wall can be built. This basic fact makes using an Allan Block facing with a NFC backfill the perfect option to the much more expensive “big block” products specified on some projects.

Internal

Internal calculations are specific to geogrid reinforced structures where the designer reviews the strength, the embedment length, and the spacing and relative position of each grid. Therefore, internal calculations are not run on gravity walls and especially not on NFC walls where the mass is a solid unit with no geogrid layers.

Bearing Capacity

Bearing calculations are run exactly the same way as a gravity wall. The biggest benefit to NFC as bearing is concerned is the larger footprint of a standard, block facing only, gravity wall. Therefore the deeper mass provides much more bearing stability to the structure than using just the facing in a typical gravity wall. Also, the weight of NFC is generally considered to be less than a traditional geogrid reinforced infill and thus provides less weight to be supported. Site soils or structural fill used in a traditional geogrid reinforced wall weighs roughly 120 pcf (1,922 kg/m³), whereas NFC, which is very porous, weighs roughly 100 pcf (1,602 kg/m³). These specific weights will vary but because of the voids, NFC will be less than structural fill gravel or site soils infill zones.

Internal Compound Stability

Internal Compound Stability (ICS) was introduced to the SRW industry in 2007 to bring a higher level of check to the internal structure of the reinforced soil mass. It uses a modified bishop global stability model to run slip arcs through the retained soils and the reinforced mass to determine if the geogrid layers are positioned correctly and have adequate strength and length. Bringing a global modeling approach into the SRW design has evolved the design approach significantly. While the traditional Internal and External calculations were and still are entirely separate, ICS effectively combines both into one set of Bishop global calculations. Why is this important to understand? An ICS design is so precise in its examination of the internal strength and stability of the reinforced mass, that if your wall section passes ICS, it will pass traditional Internal calculations as well. What this means to the designer is that if they choose to run traditional External and ICS calculations only, they can be justified in eliminating the old Internal calculations.

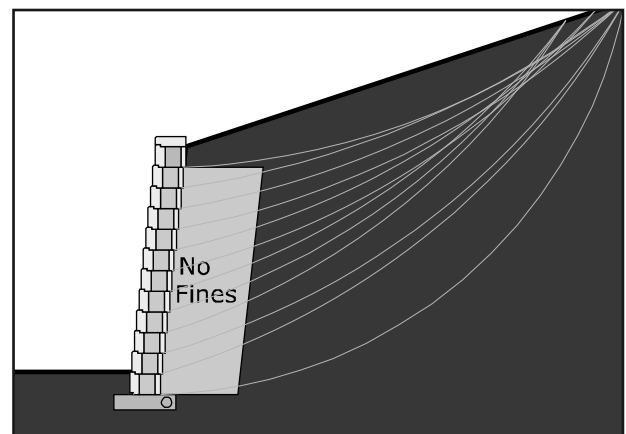

Figure D-6. NFC - ICS Analysis

How does it work? Each ICS slip arc is carefully analyzed for sliding and resisting forces. The sliding forces come from anything that is above the slip arc like the weight of the soil, any external surcharges, and in some cases seismic loading. The resisting forces come from the soil's shear strength along the length of the circular arc, the interaction with the geogrid layers and the facing. When the designer uses NFC infill, the geogrid layers are no longer there. They are replaced with the tremendously high shear strength of the NFC mass. ICS uses the internal friction angle of the soil to determine the shear strength along the arc. To determine a conservative value for what the internal friction angle of a NFC mass should be in calculation, Allan Block Corporation contracted with Braun Intertec of Minneapolis to conduct independent research onto just how to determine this value. At first thought they were reluctant to take on this challenge because typical soil mechanics would say that the friction angle of a solid mass would be infinitely strong and thus 90 degree. After careful consideration, it was decided to run a lateral shear test on multiple samples, similar to how a soil sample would be tested. The full report can be found on our website or by using the link inside of AB Walls, in the NFC section by clicking the "View Test Report" button. Braun Intertec determined a conservative friction angle of NFC to be 77.2 degrees and an average compressive strength of NFC equal to 1400 psi (9.65 MPa). Common compressive strength values will range from 900 to 1400 psi (6.18 to 9.62 MPa). AB Walls defaults to an even more conservative 75 degrees but does allow the user to reduce that value as they see fit. Now that there is a determined friction angle for the NFC, the ICS calculations can be run as normal.

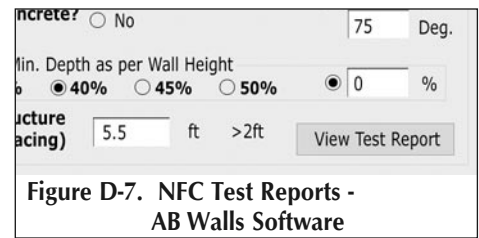

Figure D-7. NFC Test Reports - AB Walls Software

It should be noted that Complex Composite Structure design would not be possible without the advent of ICS. Traditional Internal calculations simply would not allow for varied depth structures with varied soil or infill material types. Only a global modeling program could simulate this type of structure. Even today however, a global program can only go so far. They are unable to simulate the positive effect of a block face brings to the soil structure. AB Walls and ICS can.

Complex Composite Structure designs within AB Walls use a conservative approach to traditional External calculations and utilizes the precise analysis of ICS to verify the internal stability of the entire structure to provide the designer the confidence of overall structure stability.

For engineers and wall installers, NFC has proven to be a powerful option for many difficult site challenges. It is easy to design in AB Walls and even easier to use on the job site. For more information on NFC or to get a copy of the AB Walls Design Software, contact the Allan Block Engineering Department at engineering@allanblock.com.

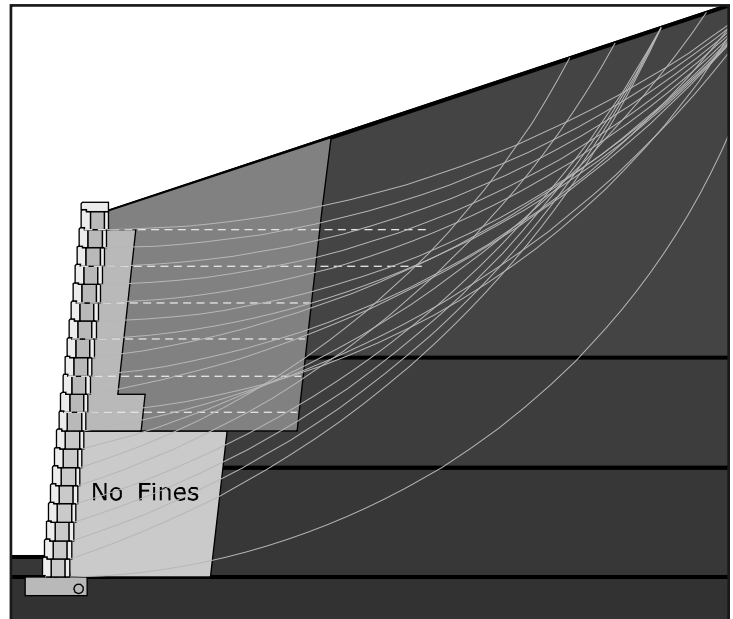

Figure D-8. NFC/Geogrid CCS Section - ICS Analysis

APPENDIX E

Building with No Fines Concrete

One of the biggest challenges faced by the Segmental Retaining Wall (SRW) industry is maximizing usable space while minimizing cost. All too often, an owner will opt for a cast in place (CIP) wall or a big block wall over using a traditional geogrid reinforced SRW. They reason that excavation for proper geogrid embedment will be either cost or space prohibitive. However, in a number of these situations, SRW's can still be the most effective solution when used in conjunction with no fines concrete (NFC). No fines concrete, as the name implies, is simply a concrete product that doesn't contain sand or fine materials. NFC is used to greatly increase gravity wall heights while maintaining a minimal excavation depth.

The idea of NFC is not a new concept. NFC dates back to the 1800s in Europe. It was originally created for the sake of cost savings by minimizing cement and sand requirements. It gained popularity in the wake of WWII across Europe because cement supplies were limited. NFC was first used in segmental retaining walls over 25 years ago.

The concept of NFC is simple. Begin with a coarse aggregate material with an average size of 0.75 in (20 mm) with no material less than 0.325 in (10 mm). Mix aggregate with cement in a six to one ratio. Once the cement is thoroughly mixed with the aggregate, add water in the volume indicated to the right, do not over water the mix. Rocks should appear thoroughly coated but not runny. Because NFC is mixed using coarse aggregate, it is quite porous and until cured will have a slump similar to wet aggregate by itself. NFC is sometimes referred to as pervious concrete, porous concrete or permeable concrete. However, in regards to retaining wall design, NFC is different from these other mixes in one very important way. The aggregate size for the others is much smaller and thus they are much less porous. NFC with the larger aggregates allow water to pass easily through it just like the washed Wall Rock in a traditional geogrid reinforced wall.

NFC should be considered a modified structural fill for walls. The inclusion of cement enhances the soil friction angle of the aggregate that can be best described as a permanent type of cohesion once the mix is cured. Independent testing was conducted to determine conservative values for both the internal friction angle and the compressive strength of NFC. The final test report provided an average friction angle of 77.2 degrees and an average compressive strength of 1400 psi (9.62 MPa). Common compressive strength values will range from 900 to 1400 psi (6.18 to 9.62 MPa). From a structural design standpoint, NFC structures can be easily evaluated using a modified Bishops analysis through a method called Internal Compound Stability (ICS). For an in depth discussion on ICS please see the Tech Sheet #807 at allanblock.com.

There are a number of situations that warrant the consideration of NFC. The most common scenario is when space is of the utmost concern. Whether the wall is placed tightly with a property line or an owner is looking to maximize their usable space, NFC allows contractors to build taller with less excavation. Industry standards recommend a minimum of sixty percent of total wall height be used for geogrid embedment depth. However, forty percent of the total wall height is a common depth for NFC.



Example Calculation	
Aggregate	- 0.81 yd ³ (0.62 m ³)
Cement	- 0.14 yd ³ (0.107 m ³)
Water	- 10 gal (38L)
Total	- 1 yd³ (0.76 m³)

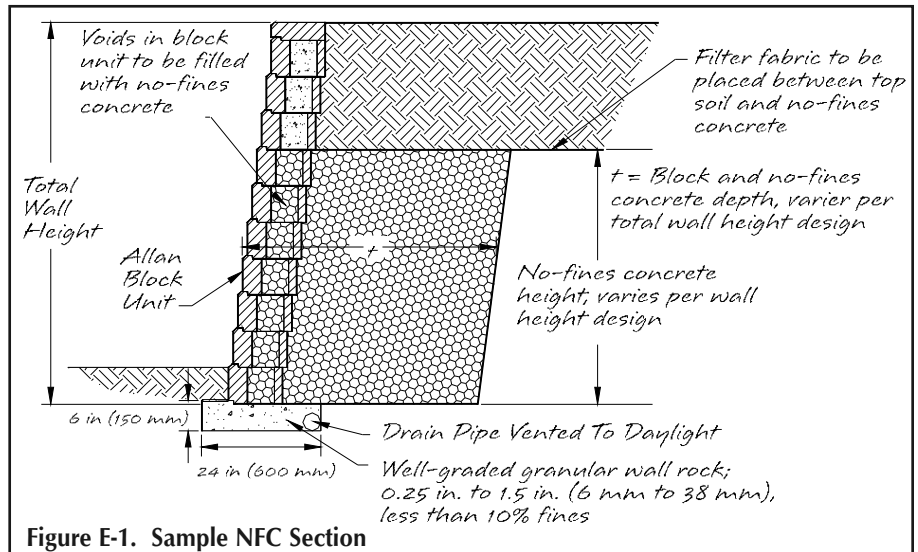

Figure E-1. Sample NFC Section

Less excavation translates to more usable space and a reduced cost of installation. Another situation where NFC can present significant cost savings is a site with walls specified as big block gravity walls. By using NFC, contractors can add a significant amount of weight and depth to the facing making their wall mimic the overall size and stability of a big block gravity wall at a greatly reduced cost. Furthermore, by using NFC with Allan Block retaining wall units, contractors can effectively eliminate the need for heavy equipment on site. This means retaining walls can be installed with smaller crews, smaller equipment, and further reduced costs. There is also a large shipping cost savings to be had. Due to the extraordinary weight of just one big block, every truck can transport a much greater square footage of Allan Block per load.

A third common application of NFC is in Complex Composite Structures (CCS). CCS is a term used generally to describe retaining wall structures that incorporate multiple reinforcement methods or soil types. For example, consider a site having a sizable retaining wall in close proximity to bedrock for a portion of its height. The retaining wall can be designed and constructed using NFC at the bottom until it reaches the height of the bedrock. Once the wall has cleared the bedrock height, geogrid reinforcement may be used for the remainder of construction. Conversely, if a wall is being built in close proximity to future building foundations a contractor might begin with geogrid and transition to NFC at the top of the wall. No fines concrete can be a simple solution to a variety of challenges that a site might present.

Building retaining walls using NFC is similar to building them with structural fill. In fact, in some ways it is easier to install a retaining wall using NFC. Begin by creating a leveling pad of compacted gravel base and setting the base course of block as detailed in the AB Commercial Installation Manual. Next, fill all the voids in the base course and backfill to the specified depth with NFC. There is no need to compact NFC. Simply move it around with a shovel and it will begin to cure in a short time. When constructing straight sections of wall using NFC, Allan Block recommends removing one back wing per block (as shown here). This will allow NFC to flow into the void between the block webs which helps to secure the block face to the NFC backfill. The vertical lift of a pour should not exceed 16 in. (406 mm) or two courses of block. This will allow for the installer to easily rod the NFC into the cores of the lower course ensuring the voids are full. It is not required to let the NFC cure between pours because it will start to cure soon after being placed. For this reason, it is sometimes referred to as stabilized aggregate. You can continue to pour the NFC mix until the two course lift is roughly level with the top block without concern of having high hydraulic loads build up behind the block. Before allowing the NFC to cure, excess material must be brushed off the top of the block to aid in the installation of the following courses of block. If any NFC spills onto the face of the block, it is important to remove it before it cures. Using a brush and clean water helps to remove the cement past. Repeat this process until the wall has reached its designed height. The top may be finished just like a typical segmental retaining wall with filter fabric topped with 8 to 12 in. (200 to 300 mm) of low permeability fill or topsoil.

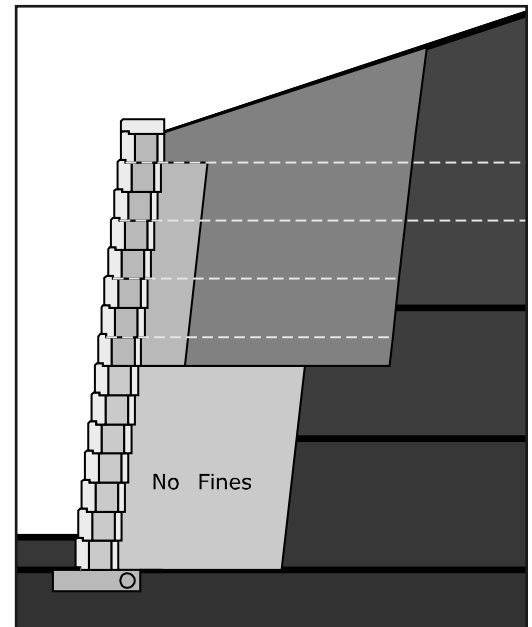
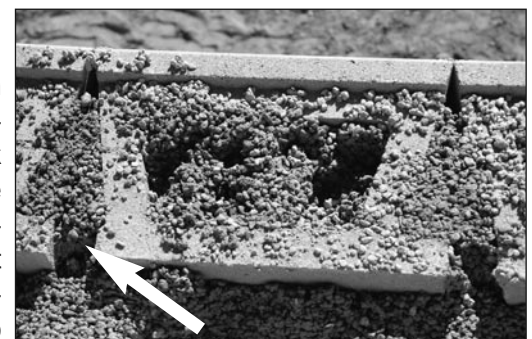

Figure E-2. NFC/Geogrid CCS Section



Remove One Back Wing Per Block

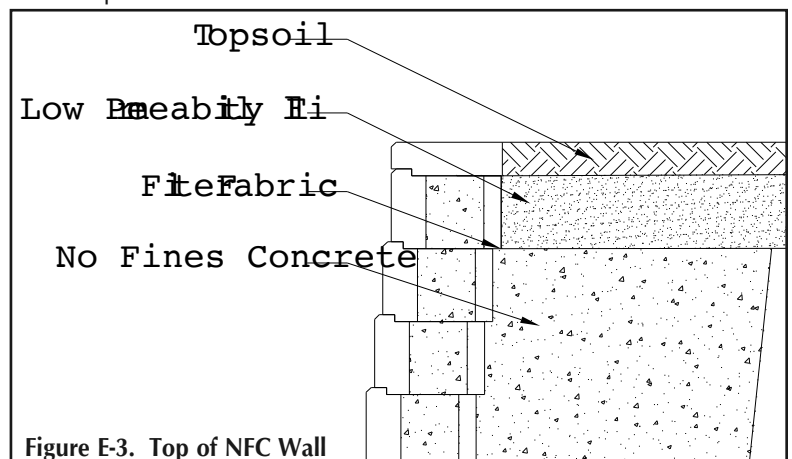

Figure E-3. Top of NFC Wall

There are a number of ways to mix NFC and to pour it behind the wall. Depending on the size and complexity and access to the site you may employ the use of a ready-mix truck directly from a local plant, use a portable on-site concrete mixer, or a ribbon mixer attachment on a skid steer. However your NFC is mixed the next step is getting it to the wall. The most common way to transport the NFC mix is in the bucket of your skid steer. This will allow you to transport a large quantity to even the most difficult wall locations on site. Ultimately each site will dictate the most effective mixing and transportation option that will be the most cost effective for your project.

There are many advantages to using NFC. Contractors can build walls quickly and with less excavation in difficult sites to solve a variety of negative site conditions. The use of NFC backfill also eliminates the need for compaction and compaction testing of the reinforced soil and it provides superior wall drainage since the entire “wall” mass is permeable. NFC eliminates the need for wall rock in the cores and behind the wall facing. The use of NFC to overcome the various site obstacles can greatly reduce costs on many projects compared to other options.

For information regarding retaining wall design using no fines concrete see our Tech Sheet #517 on No Fines with AB Walls Design Software.



APPENDIX F

This example has been constructed following methodology outlined in this manual and the references listed on page 99.

Sample Calculations

Example S-1:

Given:

$$\begin{aligned} i &= 0^\circ \\ \phi &= 36^\circ \\ \beta &= 90 - 3 = 87^\circ \\ \phi_w &= (0.666)(36) = 24^\circ \end{aligned}$$

$$\begin{aligned} H &= 3.18 \text{ ft} \quad (0.97 \text{ m}) \\ \gamma &= 120 \text{ lb/ft}^3 \quad (1,923 \text{ kg/m}^3) \\ \gamma_{\text{wall}} &= 130 \text{ lb/ft}^3 \quad (2,061 \text{ kg/m}^3) \end{aligned}$$

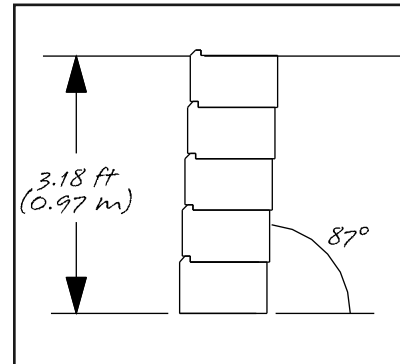

$$K_a = \left[\frac{\csc(\beta) \sin(\beta - \phi)}{\sqrt{\sin(\beta + \phi_w)} + \sqrt{\frac{\sin(\phi + \phi_w) \sin(\phi - i)}{\sin(\beta - i)}}} \right]^2$$

$$K_a = \left[\frac{\csc(87) \sin(87 - 36)}{\sqrt{\sin(87 + 24)} + \sqrt{\frac{\sin(36 + 24) \sin(36 - 0)}{\sin(87 - 0)}}} \right]^2$$

$$K_a = \left[\frac{0.7782124}{0.966219657 + 0.713957656} \right]^2 = 0.2145$$

Find: The safety factor against sliding, SFS.

The first step is to determine the total active force exerted by the soil on the wall:

$$\begin{aligned} F_a &= (0.5)(\gamma)(K_a)(H)^2 = (0.5)(120 \text{ lb/ft}^3)(0.2145)(3.18 \text{ ft})^2 = 130 \text{ lb/ft} \\ &= (0.5)(\gamma)(K_a)(H)^2 = (0.5)(1,923 \text{ kg/m}^3)(0.2145)(0.97 \text{ m})^2 = 1,904 \text{ N/m} \end{aligned}$$

$$\begin{aligned} F_{ah} &= (F_a) \cos(\phi_w) = (130 \text{ lb/ft}) \cos(24^\circ) = 119 \text{ lb/ft} \\ &= (F_a) \cos(\phi_w) = (1,904 \text{ N/m}) \cos(24^\circ) = 1,739 \text{ N/m} \end{aligned}$$

$$\begin{aligned} F_{av} &= (F_a) \sin(\phi_w) = (130 \text{ lb/ft}) \sin(24^\circ) = 53 \text{ lb/ft} \\ &= (F_a) \sin(\phi_w) = (1,904 \text{ N/m}) \sin(24^\circ) = 774 \text{ N/m} \end{aligned}$$

$$\begin{aligned} W_f &= (\gamma_{\text{wall}})(H)(d) = (130 \text{ lb/ft}^3)(3.18 \text{ ft})(0.97 \text{ ft}) = 401 \text{ lb/ft} \\ &= (\gamma_{\text{wall}})(H)(d) = (2,061 \text{ kg/m}^3)(0.97 \text{ m})(0.3 \text{ m}) = 5,884 \text{ N/m} \end{aligned}$$

$$\begin{aligned} F_r &= (V_t)(C_f) = (W_f + F_v) \tan(\phi) = (401 \text{ lb/ft} + 53 \text{ lb/ft}) \tan(36^\circ) = 330 \text{ lb/ft} \\ &= (V_t)(C_f) = (W_f + F_v) \tan(\phi) = (5,884 \text{ N/m} + 774 \text{ N/m}) \tan(36^\circ) = 4,837 \text{ N/m} \end{aligned}$$

$$\text{SFS} = \frac{F_r}{F_{ah}} = \frac{330 \text{ lb/ft}}{119 \text{ lb/ft}} = 2.77 \geq 1.5 \text{ OK} \quad = \frac{F_r}{F_h} = \frac{4,837 \text{ N/m}}{1,739 \text{ N/m}} = 2.77 \geq 1.5 \text{ OK}$$

Find: The safety factor against overturning, SFO.

$$\begin{aligned}\Sigma M_r &= (W_f) [(x_1) + (0.5) (H) \tan (90^\circ - \beta)] \\ &+ (F_{av}) [(x_2) + (0.333) (H) \tan (90^\circ - \beta)] \\ &= (401 \text{ lb/ft}) [(0.49 \text{ ft}) + (0.5) (3.18 \text{ ft}) \tan (90^\circ - 87^\circ)] \\ &+ (53 \text{ lb/ft}) [(0.97 \text{ ft}) + (0.333) (3.18 \text{ ft}) \tan (90^\circ - 87^\circ)] \\ &= 284 \text{ ft-lb/ft} \\ &= (5,884 \text{ N/m}) [(0.15 \text{ m}) + (0.5) (0.97 \text{ m}) \tan (90^\circ - 87^\circ)] \\ &+ (774 \text{ N/m}) [(0.3 \text{ m}) + (0.333) (0.97 \text{ m}) \tan (90^\circ - 87^\circ)] \\ &= 1,277 \text{ N-m/m}\end{aligned}$$

$$\begin{aligned}M_o &= (F_{ah}) (0.333) (H) \\ &= (119 \text{ lb/ft}) (0.333) (3.18 \text{ ft}) = 126 \text{ ft-lb/ft}\end{aligned}$$

$$= (1,739 \text{ N/m}) (0.333) (0.97 \text{ m}) = 562 \text{ N-m/m}$$

$$\text{SFO} = \frac{\Sigma M_r}{\Sigma M_o} = \frac{(284 \text{ ft-lb/ft})}{(126 \text{ ft-lb/ft})} = 2.25 \geq 2.0 \text{ OK}$$

$$= \frac{\Sigma M_r}{\Sigma M_o} = \frac{(1,277 \text{ N-m/m})}{(562 \text{ N-m/m})} = 2.25 \geq 2.0 \text{ OK}$$

Example S-2:

Given:

$$\phi = 36^\circ$$

$$H = 3.18 \text{ ft } (0.97 \text{ m})$$

$$\beta = 90 - 12 = 78^\circ$$

$$i = 0^\circ$$

$$\gamma = 120 \text{ lb/ft}^3 \quad (1,923 \text{ kg/m}^3)$$

$$\gamma_w = 130 \text{ lb/ft}^3 \quad (2,061 \text{ kg/m}^3)$$

$$q = 250 \text{ lb/ft}^2 \quad (11,974 \text{ Pa})$$

$$\phi_w = (0.666) (36) = 24^\circ$$

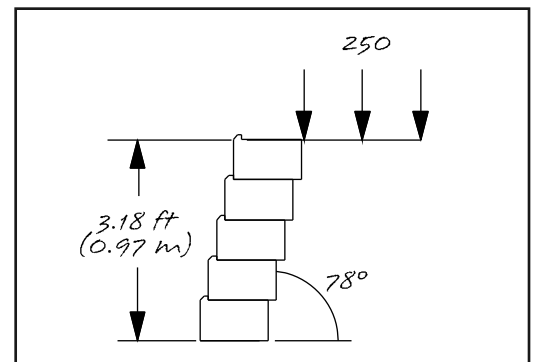

$$K_a = \left[\frac{\csc(\beta) \sin(\beta - \phi)}{\sqrt{\sin(\beta + \phi_w) + \frac{\sin(\phi + \phi_w) \sin(\phi - i)}{\sin(\beta - i)}}} \right]^2$$

$$K_a = \left[\frac{\csc(78) \sin(78 - 36)}{\sqrt{\sin(78 + 24) + \frac{\sin(36 + 24) \sin(36 - 0)}{\sin(78 - 0)}}} \right]^2$$

$$K_a = \left[\frac{0.684079382}{0.989013448 + 0.72139389} \right]^2 = 0.1599$$

Find: The safety factor against sliding, SFS.

The first step is to determine the total active force exerted by the soil on the wall:

$$F_a = (0.5) (\gamma) (K_a) (H)^2 = (0.5) (120 \text{ lb/ft}^3) (0.1599) (3.18 \text{ ft})^2 = 97 \text{ lb/ft}$$

$$= (0.5) (\gamma) (K_a) (H)^2 = (0.5) (1,923 \text{ kg/m}^3) (0.1599) (0.97 \text{ m})^2 = 1,419 \text{ N/m}$$

$$F_{ah} = (F_a) \cos (\phi_w) = (97 \text{ lb/ft}) \cos (24^\circ) = 89 \text{ lb/ft}$$

$$= (F_a) \cos (\phi_w) = (1,419 \text{ N/m}) \cos (24^\circ) = 1,296 \text{ N/m}$$

$$F_{av} = (F_a) \sin (\phi_w) = (97 \text{ lb/ft}) \sin (24^\circ) = 39 \text{ lb/ft}$$

$$= (F_a) \sin (\phi_w) = (1,419 \text{ N/m}) \sin (24^\circ) = 577 \text{ N/m}$$

$$W_f = (\gamma_{\text{wall}}) (H) (d) = (130 \text{ lb/ft}^3) (3.18 \text{ ft}) (0.97 \text{ ft}) = 401 \text{ lb/ft}$$

$$= (\gamma_{\text{wall}}) (H) (d) = (2,061 \text{ kg/m}^3) (0.97 \text{ m}) (0.3 \text{ m}) = 5,883 \text{ N/m}$$

$$F_r = (V_t) (C_f) = (W_f + F_v) \tan (\phi) = (401 \text{ lb/ft} + 39 \text{ lb/ft}) \tan (36^\circ) = 370 \text{ lb/ft}$$

$$= (V_t) (C_f) = (W_f + F_v) \tan (\phi) = (5,883 \text{ N/m} + 577 \text{ N/m}) \tan (36^\circ) = 4,693 \text{ N/m}$$

$$P_q = (q) (K_a) = (250 \text{ lb/ft}^2) (0.1599) = 40 \text{ lb/ft}^2$$

$$= (q) (K_a) = (11,974 \text{ N/m}^2) (0.1599) = 1,916 \text{ Pa}$$

$$P_{qh} = (P_q) \cos (\phi_w) = (40 \text{ lb/ft}^2) \cos (24^\circ) = 37 \text{ lb/ft}^2$$

$$= (P_q) \cos (\phi_w) = (1,916 \text{ Pa}) \cos (24^\circ) = 1,750 \text{ Pa}$$

$$P_{qv} = (P_q) \sin (\phi_w) = (40 \text{ lb/ft}^2) \sin (24^\circ) = 16 \text{ lb/ft}^2$$

$$= (P_q) \sin (\phi_w) = (1,916 \text{ Pa}) \sin (24^\circ) = 779 \text{ Pa}$$

$$F_{qh} = (P_{qh}) (H) = (37 \text{ lb/ft}^2) (3.18 \text{ ft}) = 118 \text{ lb/ft}$$

$$= (P_{qh}) (H) = (1,772 \text{ Pa}) (0.97 \text{ m}) = 1,719 \text{ N/m}$$

$$F_{qv} = (P_{qv}) (H) = (16 \text{ lb/ft}^2) (3.18 \text{ ft}) = 51 \text{ lb/ft}$$

$$= (P_{qv}) (H) = (766 \text{ Pa}) (0.97 \text{ m}) = 743 \text{ N/m}$$

$$\text{SFS} = \frac{F_r + (F_{qv}) (C_f)}{F_h + F_{qh}} = \frac{320 \text{ lb/ft} + (51 \text{ lb/ft}) \tan (36^\circ)}{89 \text{ lb/ft} + 118 \text{ lb/ft}} = 1.72 \geq 1.5 \quad \text{OK}$$

$$= \frac{F_r + (F_{qv}) (C_f)}{F_h + F_{qh}} = \frac{4,693 \text{ N/m} + (743 \text{ N/m}) \tan (36^\circ)}{1,296 \text{ N/m} + 1,719 \text{ N/m}} = 1.72 \geq 1.5 \quad \text{OK}$$

Find: The safety factor against overturning, SFO.

$$\begin{aligned}\Sigma M_r &= (W_f) [(X_1) + (0.5) (H) \tan (90^\circ - \beta)] \\ &+ (F_{av}) [(X_2) + (0.333) (H) \tan (90^\circ - \beta)] \\ &+ (F_{qv}) [(X_2) + (0.5) (H) \tan (90^\circ - \beta)] \\ \Sigma M_r &= (401 \text{ lb/ft}) [(0.49 \text{ ft}) + (0.5) (3.18 \text{ ft}) \tan (90^\circ - 78^\circ)] \\ &+ (39 \text{ lb/ft}) [(0.97 \text{ ft}) + (0.333) (3.18 \text{ ft}) \tan (90^\circ - 78^\circ)] \\ &+ (51 \text{ lb/ft}) [(0.97 \text{ ft}) + (0.5) (3.18 \text{ ft}) \tan (90^\circ - 78^\circ)] \\ &= 445 \text{ ft-lb/ft}\end{aligned}$$

$$\begin{aligned}&= (5,883 \text{ N/m}) [(0.15 \text{ m}) + (0.5) (0.97 \text{ m}) \tan (90^\circ - 78^\circ)] \\ &+ (577 \text{ N/m}) [(0.3 \text{ m}) + (0.333) (0.97 \text{ m}) \tan (90^\circ - 78^\circ)] \\ &+ (743 \text{ N/m}) [(0.3 \text{ m}) + (0.5) (0.97 \text{ m}) \tan (90^\circ - 78^\circ)] \\ &= 2,001 \text{ N-m/m}\end{aligned}$$

$$\begin{aligned}M_o &= (F_{ah}) (0.333) (H) + (F_{qh}) (0.5) (H) \\ &= (89 \text{ lb/ft}) (0.333) (3.18 \text{ ft}) + (118 \text{ lb/ft}) (0.5) (3.18 \text{ ft}) = 282 \text{ ft-lb/ft} \\ &= (1,296 \text{ N-m}) (0.333) (0.97 \text{ m}) + (1,719 \text{ N-m}) (0.5) (0.97 \text{ m}) = 1,252 \text{ N-m/m}\end{aligned}$$

$$\begin{aligned}\text{SFO} &= \frac{\Sigma M_r}{\Sigma M_o} = \frac{(445 \text{ ft-lb/ft})}{(282 \text{ ft-lb/ft})} = 1.58 \geq 2.0 \text{ NOT OK} \\ &= \frac{\Sigma M_r}{\Sigma M_o} = \frac{(2,001 \text{ N-m/m})}{(1,252 \text{ N-m/m})} = 1.58 \geq 2.0 \text{ NOT OK}\end{aligned}$$

Example S-3:

Given:

$\phi = 27^\circ$	$i = 0^\circ$	$\gamma = 120 \text{ lb/ft}^3$ (1,923 kg/m ³)
$H = 9.52 \text{ ft}$ (2.9 m)	$C_i = 0.75$	$\gamma_{\text{wall}} = 130 \text{ lb/ft}^3$ (2,061 kg/m ³)
$\beta = 90 - 12 = 78^\circ$	$\phi_w = (0.666) (27) = 18^\circ$	$q = 250 \text{ lb/ft}^2$ (11,974 Pa)

$$\begin{aligned}K_a &= \left[\frac{\csc(\beta) \sin(\beta - \phi)}{\sqrt{\sin(\beta + \phi_w) + \frac{\sin(\phi + \phi_w) \sin(\phi - i)}{\sin(\beta - i)}}} \right]^2 \\ K_a &= \left[\frac{\csc(78) \sin(78 - 27)}{\sqrt{\sin(78 + 18) + \frac{\sin(27 + 18) \sin(27 - 0)}{\sin(78 - 0)}}} \right]^2 \\ K_a &= \left[\frac{0.794507864}{0.997257186 + 0.572880034} \right]^2 = 0.256\end{aligned}$$

Find: The safety factor against sliding, SFS.

The first step is to determine the total active force exerted by the soil on the wall:

$$F_a = (0.5) (\gamma) (K_a) (H)^2 = (0.5) (120 \text{ lb/ft}^3) (0.256) (9.52 \text{ ft})^2 = 1,392 \text{ lb/ft}$$

$$= (0.5) (\gamma) (K_a) (H)^2 = (0.5) (1,923 \text{ kg/m}^3) (0.256) (2.9 \text{ m})^2 = 20,307 \text{ N/m}$$

$$F_{ah} = (F_a) \cos (\phi_w) = (1,392 \text{ lb/ft}) \cos (18^\circ) = 1,324 \text{ lb/ft}$$

$$= (F_a) \cos (\phi_w) = (20,307 \text{ N/m}) \cos (18^\circ) = 19,313 \text{ N/m}$$

$$F_{av} = (F_a) \sin (\phi_w) = (1,392 \text{ lb/ft}) \sin (18^\circ) = 430 \text{ lb/ft}$$

$$= (F_a) \sin (\phi_w) = (20,307 \text{ N/m}) \sin (18^\circ) = 6,275 \text{ N/m}$$

$$W_f = (\gamma_{\text{wall}}) (H) (d) = (130 \text{ lb/ft}^3) (9.52 \text{ ft}) (0.97 \text{ ft}) = 1,200 \text{ lb/ft}$$

$$= (\gamma_{\text{wall}}) (H) (d) = (2,061 \text{ kg/m}^3) (2.9 \text{ m}) (0.3 \text{ m}) = 17,590 \text{ N/m}$$

$$F_r = (V_t) (C_f) = (W_f + F_v) \tan (\phi) = (1,200 \text{ lb/ft} + 430 \text{ lb/ft}) \tan (27^\circ) = 831 \text{ lb/ft}$$

$$= (V_t) (C_f) = (W_f + F_v) \tan (\phi) = (17,590 \text{ N/m} + 6,275 \text{ N/m}) \tan (27^\circ) = 12,160 \text{ N/m}$$

$$\text{SFS} = \frac{F_r}{F_h} = \frac{831 \text{ lb/ft}}{1,324 \text{ lb/ft}} = 0.63 \geq 1.5 \text{ NOT OK (Need Geogrid)}$$

$$= \frac{F_r}{F_h} = \frac{12,160 \text{ N/m}}{19,313 \text{ N/m}} = 0.63 \geq 1.5 \text{ NOT OK (Need Geogrid)}$$

Determine if a single layer of grid will work in calculation. This single grid layer example is for instructional purposes only. All actual reinforced mass designs require at least two layers of grid and most are designed using a two course spacing of geogrid from the bottom of wall to the top, regardless of the minimum grid layer calculations which follows.

$$F_{gr} = 2 (d_g) (\gamma) (L_e) (C_i) \tan (\phi)$$

Find L_e .

$$L_e = \frac{833 \text{ lb/ft}}{2 (5.08 \text{ ft}) (120 \text{ lb/ft}^3) (0.75) \tan (27^\circ)} = 1.79 \text{ ft}$$

$$= \frac{12,161 \text{ N/m}}{2 (1.55 \text{ m}) (18,865 \text{ N/m}) (0.75) \tan (27^\circ)} = 0.544 \text{ m}$$

$$L_t = L_w + L_a + L_e = 0.85 + (H - d_g) [\tan (45^\circ - (\phi/2)) - \tan (90^\circ - \beta)] + 1.79 \text{ ft}$$

$$= 0.85 \text{ ft} + (9.52 \text{ ft} - 5.08 \text{ ft}) [\tan (45^\circ - 13.5^\circ) - \tan (90^\circ - 78^\circ)] + 1.79 \text{ ft}$$

$$= 4.42 \text{ ft}$$

$$= L_w + L_a + L_e = 0.85 + (H - d_g) [\tan (45^\circ - (\phi/2)) - \tan (90^\circ - \beta)] + 0.544 \text{ m}$$

$$= 0.259 \text{ m} + (2.9 \text{ m} - 1.55 \text{ m}) [\tan (45^\circ - 13.5^\circ) - \tan (90^\circ - 78^\circ)] + 0.544 \text{ m}$$

$$= 1.34 \text{ m}$$

Actual Embedment Length.

$$L_e = (L_t - L_w - L_a)$$

$$= 4.42 \text{ ft} - 0.85 \text{ ft} - (9.52 \text{ ft} - 5.08 \text{ ft}) (0.4) = 1.79 \text{ ft}$$

$$= 1.34 \text{ m} - 0.259 \text{ m} - (2.9 \text{ m} - 1.55 \text{ m}) (0.4) = 0.544 \text{ m}$$

Maximum potential restraining force with $L_e = 1.79 \text{ ft} (0.544 \text{ m})$.

$$F_{gr} = 2 (5.08 \text{ ft}) (120 \text{ lb/ft}^3) (1.79 \text{ ft}) (0.75) \tan (27^\circ) = 833 \text{ lb/ft}$$

$$= 2 (1.55 \text{ m}) (1,923 \text{ kg/m}^3) (0.541 \text{ m}) (0.75) \tan (27^\circ) = 12,090 \text{ N/m}$$

$$\text{SFS} = \frac{F_r + F_g}{F_h} = \frac{831 \text{ lb/ft} + 833 \text{ lb/ft}}{1,324 \text{ lb/ft}} = 1.25 \geq 1.5 \text{ NOT OK (Needs More Geogrid)}$$

$$= \frac{F_r + F_g}{F_h} = \frac{12,160 \text{ N/m} + 12,090 \text{ N/m}}{19,313 \text{ N/m}} = 1.25 \geq 1.5 \text{ NOT OK (Needs More Geogrid)}$$

$$L_{\min} = 0.3 (H) + 0.85 \text{ ft} + 2.4 \text{ ft} = 0.3 (9.52 \text{ ft}) + 0.85 \text{ ft} + 1.79 \text{ ft} = 5.5 \text{ ft}$$

$$= 0.3 (H) + 0.256 \text{ m} + 0.732 \text{ m} = 0.3 (2.9 \text{ m}) + 0.256 \text{ m} + 0.544 \text{ m} = 1.67 \text{ m}$$

$$W_s = (\gamma_r) (H) (L_g - 0.85 \text{ ft}) = (125 \text{ lb/ft}^3) (9.52 \text{ ft}) (5.5 \text{ ft} - 0.85 \text{ ft}) = 5,534 \text{ lb/ft}$$

$$= (\gamma_r) (H) (L_g - 0.256 \text{ m}) = (2,002 \text{ kg/m}^3) (2.9 \text{ m}) (1.67 \text{ m} - 0.256 \text{ m}) = 80,534 \text{ N/m}$$

$$W_w = W_f + W_s = 1,200 \text{ lb/ft} + 5,534 \text{ lb/ft} = 6,734 \text{ lb/ft}$$

$$= W_f + W_s = 17,590 \text{ N/m} + 80,534 \text{ N/m} = 98,124 \text{ N/m}$$

Vertical Force; Solve using onsite soil

$$V_t = W_w + F_{av} = 6,734 \text{ lb/ft} + 430 \text{ lb/ft} = 7,164 \text{ lb/ft}$$

$$= W_w + F_{av} = 98,124 \text{ N/m} + 6,275 \text{ N/m} = 104,399 \text{ N/m}$$

$$F_r = (V_t) (C_f) = (7,164 \text{ lb/ft}) \tan (27^\circ) = 3,650 \text{ lb/ft}$$

$$= (V_t) (C_f) = (104,399 \text{ N/m}) \tan (27^\circ) = 53,193 \text{ N/m}$$

Pressure on the retaining wall due to the surcharge

$$P_q = (q) (K_a) = (250 \text{ lb/ft}^2) (0.256) = 64 \text{ lb/ft}^2$$

$$= (q) (K_a) = (11,974 \text{ Pa}) (0.256) = 3,065 \text{ Pa}$$

Find the horizontal and vertical components of the pressure.

$$P_{qh} = (P_q) \cos (\phi_w) = (64 \text{ lb/ft}^2) \cos (18^\circ) = 61 \text{ lb/ft}^2$$

$$= (P_q) \cos (\phi_w) = (3,065 \text{ Pa}) \cos (18^\circ) = 2,915 \text{ Pa}$$

$$P_{qv} = (P_q) \sin (\phi_w) = (64 \text{ lb/ft}^2) \sin (18^\circ) = 20 \text{ lb/ft}^2$$

$$= (P_q) \sin (\phi_w) = (3,065 \text{ Pa}) \sin (18^\circ) = 947 \text{ Pa}$$

Finally, the total surcharge forces on the wall are calculated:

$$F_{qh} = (P_{qh}) (H) = (61 \text{ lb/ft}^2) (9.52 \text{ ft}) = 581 \text{ lb/ft}$$

$$= (P_{qh}) (H) = (2,915 \text{ Pa}) (2.9 \text{ m}) = 8,454 \text{ N/m}$$

$$F_{qv} = (P_{qv}) (H) = (20 \text{ lb/ft}^2) (9.52 \text{ ft}) = 190 \text{ lb/ft}$$

$$= (P_{qv}) (H) = (947 \text{ Pa}) (2.9 \text{ m}) = 2,746 \text{ N/m}$$

Find the safety factor against sliding:

$$\text{SFS} = \frac{F_r + (F_{qv}) \tan \phi}{F_h + F_{qh}} = \frac{3,650 \text{ lb/ft} + 190 \text{ lb/ft} (\tan 27^\circ)}{1,324 \text{ lb/ft} + 581 \text{ lb/ft}} = 1.97 \geq 1.5 \text{ OK}$$

$$= \frac{F_r + (F_{qv}) \tan \phi}{F_h + F_{qh}} = \frac{53,193 \text{ N/m} + 2,746 \text{ N/m} (\tan 27^\circ)}{19,313 \text{ N/m} + 8,454 \text{ N/m}} = 1.97 \geq 1.5 \text{ OK}$$

Find the safety factor against overturning:

$$\begin{aligned}
 \Sigma M_r &= (W_f) [(0.5) (X_1) + (0.5) (H) \tan (90^\circ - \beta)] \\
 &+ (W_s) [(0.5) (X_2 - X_1) + (X_1) + (0.5) (H) \tan (90^\circ - \beta)] \\
 &+ (F_{av}) [(X_2) + (0.333) (H) \tan (90^\circ - \beta)] \\
 &+ (F_{qv}) [(X_2) + (0.5) (H) \tan (90^\circ - \beta)] \\
 &= (1,200 \text{ lb/ft}) [(0.5) (0.97 \text{ ft}) + (0.5) (9.52 \text{ ft}) \tan (90^\circ - 78^\circ)] \\
 &+ (5,534 \text{ lb/ft}) [(0.5) (5.62 \text{ ft} - 0.97 \text{ ft}) + (0.97 \text{ ft}) + (0.5) (9.52 \text{ ft}) \tan (90^\circ - 78^\circ)] \\
 &+ (430 \text{ lb/ft}) [(5.62 \text{ ft}) + (0.333) (9.52 \text{ ft}) \tan (90^\circ - 78^\circ)] \\
 &+ (190 \text{ lb/ft}) [(5.62 \text{ ft}) + (0.5) (9.52 \text{ ft}) \tan (90^\circ - 78^\circ)] \\
 &= 29,596 \text{ ft-lb/ft} \\
 &= (17,590 \text{ N/m}) [(0.5) (0.297 \text{ m}) + (0.5) (2.9 \text{ m}) \tan (90^\circ - 78^\circ)] \\
 &+ (80,534 \text{ N/m}) [(0.5) (1.71 \text{ m} - 0.297 \text{ m}) + (0.297 \text{ m}) + (0.5) (2.9 \text{ m}) \tan (90^\circ - 78^\circ)] \\
 &+ (6,275 \text{ N/m}) [(1.71 \text{ m}) + (0.333) (2.9 \text{ m}) \tan (90^\circ - 78^\circ)] \\
 &+ (2,746 \text{ N/m}) [(1.71 \text{ m}) + (0.5) (2.9 \text{ m}) \tan (90^\circ - 78^\circ)] \\
 &= 131,230 \text{ N-m/m}
 \end{aligned}$$

$$\begin{aligned}
 M_o &= (F_{ah}) (0.333) (H) + (F_{qh}) (0.5) (H) \\
 &= (1,324 \text{ lb/ft}) (0.333) (9.52 \text{ ft}) + (581 \text{ lb/ft}) (0.5) (9.52 \text{ ft}) = 6,962 \text{ ft-lb/ft} \\
 &= (19,313 \text{ N/m}) (0.333) (2.9 \text{ m}) + (8,454 \text{ N/m}) (0.5) (2.9 \text{ m}) = 30,909 \text{ N-m/m}
 \end{aligned}$$

$$\begin{aligned}
 \text{SFO} &= \frac{\Sigma M_r}{\Sigma M_o} = \frac{(29,596 \text{ ft-lb/ft})}{(6,962 \text{ ft-lb/ft})} = 4.25 \geq 2.0 \text{ OK} \\
 &= \frac{\Sigma M_r}{\Sigma M_o} = \frac{(131,230 \text{ N/m})}{(30,909 \text{ N/m})} = 4.25 \geq 2.0 \text{ OK}
 \end{aligned}$$

Internal Stability:

$$\begin{aligned}
 \phi_r &= 30^\circ \\
 \gamma_r &= 125 \text{ lb/ft}^3 \text{ (2,002 kg/m}^3\text{)} \\
 \phi_{wr} &= 0.666 (30^\circ) = 20^\circ
 \end{aligned}$$

$$\begin{aligned}
 K_{ar} &= \left[\frac{\csc (78) \sin (78 - 30)}{\sqrt{\sin (78 + 19.98)} + \sqrt{\frac{\sin (30 + 19.98) \sin (30 - 0)}{\sin (78 - 0)}}} \right]^2 \\
 K_{ar} &= \left[\frac{0.759747}{0.995147 + 0.625671} \right]^2 = 0.2197
 \end{aligned}$$

$$P_{qh} = (q) (K_{ar}) \cos (\phi_{wr}) = (250 \text{ lb/ft}^2) (0.2197) \cos (20^\circ) = 52 \text{ lb/ft}^2$$

$$= (q) (K_{ar}) \cos (\phi_{wr}) = (11,974 \text{ Pa}) (0.2197) \cos (20^\circ) = 2,472 \text{ Pa}$$

$$\text{Quadratic equation} = \frac{-b \pm \sqrt{b^2 - 4ac}}{2a}$$

$$z = (K_{ar}) \cos (\phi_{wr}) = (0.2197) \cos (20^\circ) = 0.2065$$

$$a = (\gamma_r) (z) = (125 \text{ lb/ft}^3) (0.2065) = 26 \text{ lb/ft}^3$$

$$= (\gamma_r) (z) = (2,002 \text{ kg/m}^3) (0.2065) = 413 \text{ kg/m}^3$$

$$b = -2 [(d_1) (a) + (q) (z)] = -2 [(9.52 \text{ ft}) (26 \text{ lb/ft}^3) + (250 \text{ lb/ft}^2) (0.2065)]$$

$$= -598 \text{ lb/ft}^2$$

$$= -2 [(d_1) (a) + (q) (z)] = -2 [(2.9 \text{ m}) (413 \text{ kg/m}^3) + (1,220 \text{ kg/m}^2) (0.2065)]$$

$$= -2,899 \text{ kg/m}^2$$

$$c = (2) (F_{ga}) = (2) (833 \text{ lb/ft}) = 1,666 \text{ lb/ft}$$

$$= (2) (F_{ga}) = (2) (12,161 \text{ N/m}) = 24,322 \text{ N/m}$$

$$d_h = \frac{-(-598 \text{ lb/ft}^2) \pm \sqrt{(-598 \text{ lb/ft}^2)^2 - 4 (26 \text{ lb/ft}^3) (1,666 \text{ lb/ft})}}{2 (26 \text{ lb/ft}^3)}$$

$$= \frac{(598 \text{ lb/ft}^2) \pm (429 \text{ lb/ft}^2)}{52 \text{ lb/ft}^3} = 19.75 \text{ or } 3.25$$

The wall is only 9.52 ft (2.9 m) tall so 19.75 (6.02 m) is not valid.

$$= \frac{-(-2,899 \text{ kg/m}^2) \pm \sqrt{(-2,899 \text{ kg/m}^2)^2 - 4 (413 \text{ kg/m}^3) (2,479 \text{ kg/m})}}{2 (413 \text{ kg/m}^3)}$$

$$= \frac{(2,899 \text{ kg/m}^2) \pm (2,076 \text{ kg/m}^2)}{826 \text{ kg/m}^3} = 6.02 \text{ or } 1.0$$

$$d_2 = d_1 - d_h = 9.52 \text{ ft} - 3.25 \text{ ft} = 6.27 \text{ ft}$$

$$= d_1 - d_h = 2.9 \text{ m} - 1.0 \text{ m} = 1.9 \text{ m}$$

The first layer of geogrid is placed at 1/2 d_h.

$$h_g = 1/2 d_h = 1/2 (3.25 \text{ ft}) = 1.625 \text{ ft}$$

$$= 1/2 d_h = 1/2 (1.0 \text{ m}) = 0.5 \text{ m}$$

Analysis to determine if more than one additional layer of geogrid is required;

$$F_h = 0.5 (\gamma_r) (K_{ar}) (d_2)^2 \cos (\phi_{wr}) = 0.5 (125 \text{ lb/ft}^3) (0.2197) (6.27 \text{ ft})^2 \cos (30^\circ)$$

$$= 467 \text{ lb/ft}$$

$$= 0.5 (\gamma_r) (K_{ar}) (d_2)^2 \cos (\phi_{wr}) = 0.5 (2,002 \text{ kg/m}^3) (0.2197) (1.9 \text{ m})^2 \cos (30^\circ)$$

$$= 6,745 \text{ N/m}$$

$$Q_h = (q) (K_{ar}) (d_2 - h_g) \cos (\phi_{wr}) = (250 \text{ lb/ft}^2) (0.2197) (6.27 \text{ ft} - 1.625 \text{ ft}) \cos (20^\circ)$$

$$= 240 \text{ lb/ft}$$

$$= (q) (K_{ar}) (d_2 - h_g) \cos (\phi_{wr}) = (1,220 \text{ kg/m}^2) (0.2197) (1.9 \text{ m} - 0.5 \text{ m}) \cos (20^\circ)$$

$$= 3,459 \text{ N/m}$$

$$F_t = F_h + Q_h = 467 \text{ lb/ft} + 240 \text{ lb/ft} = 707 \text{ lb/ft}$$

$$= F_h + Q_h = 6,745 \text{ N/m} + 3,459 \text{ N/m} = 10,204 \text{ N/m}$$

$$F_t = 707 \text{ lb/ft} < 833 \text{ lb/ft} \text{ Only one more layer of geogrid is required.}$$

$$= 10,204 \text{ N/m} < 12,161 \text{ N/m} \text{ Only one more layer of geogrid is required.}$$

$$h_g = (H - d_2) + 0.5 (d_h) = (9.52 \text{ ft} - 6.27 \text{ ft}) + 0.5 (3.25) = 4.875 \text{ ft}$$

$$= (H - d_2) + 0.5 (d_h) = (2.9 \text{ m} - 1.9 \text{ m}) + 0.5 (1.0 \text{ m}) = 1.5 \text{ m}$$

Check number of layers of geogrid required.

$$F_h = 0.5 (\gamma_r) (K_{ar}) (H)^2 \cos (\phi_{wr}) = 0.5 (125 \text{ lb/ft}^3) (0.2197) (9.52 \text{ ft})^2 \cos (20^\circ)$$

$$= 1,169 \text{ lb/ft}$$

$$= 0.5 (\gamma_r) (K_{ar}) (H)^2 \cos (\phi_{wr}) = 0.5 (2002 \text{ kg/m}^3) (0.2197) (2.9 \text{ m})^2 \cos (20^\circ)$$

$$= 17,050 \text{ N/m}$$

$$Q_h = (q) (K_{ar}) (H - h_g) \cos (\phi_{wr}) = (250 \text{ lb/ft}^2) (0.2197) (9.52 \text{ ft} - 1.625 \text{ ft}) \cos (20^\circ)$$

$$= 407 \text{ lb/ft}$$

$$= (q) (K_{ar}) (H - h_g) \cos (\phi_{wr}) = (11,974 \text{ N/m}^2) (0.2197) (2.9 \text{ m} - 0.5 \text{ m}) \cos (20^\circ)$$

$$= 5,933 \text{ N/m}$$

$$F_t = F_h + Q_h = 1,169 \text{ lb/ft} + 407 \text{ lb/ft} = 1,576 \text{ lb/ft}$$

$$= F_h + Q_h = 17,050 \text{ N/m} + 5,933 \text{ N/m} = 22,983 \text{ N/m}$$

$$\frac{F_t}{\text{LTADS}} = N = \frac{1,576 \text{ lb/ft}}{833 \text{ lb/ft}} = 1.89 = 2 \text{ Layers}$$

$$= N = \frac{22,983 \text{ N/m}}{12,161 \text{ N/m}} = 1.89 = 2 \text{ Layers}$$

One layer of grid will not be sufficient for the stability of this 9.52 ft (2.9 m) tall wall. A 9.52 ft (2.9 m) tall wall will have 15 block courses. Typically a geogrid reinforced wall will be designed and constructed using geogrid on every other block course minimum. That would give this wall 7 layers of geogrid starting above the bottom course. They would also be designed with a minimum length of grid equal to 60% of the wall height and increased from there as the design requires.



**ALLAN
BLOCK**

allanblock.com

APPENDIX G

This manual uses a working Stress Approach to the analysis of segmental retaining walls. When using a working Stress Approach the final analysis should yield a Factor of Safety for Static Conditions of 1.3 to 2.0 depending on the condition being analyzed. The following examples have converted the approach outlined in this manual into a Limit States Design Approach. The main difference between a working Stress Approach and Limit States Approach is based on the introduction of load factors and reduction factors. The net result of either approach should yield similar wall designs. Final Factors of Safety for a Limit States Approach are only required to exceed 1.0, due to the fact that reductions and load factors are applied during the analysis.

Example: Limit States Design Analysis for a Gravity Wall

Given:

$\phi = 36^\circ$	$H = 3.15 \text{ ft}$	(0.96 m)
$i = 0^\circ$	$\gamma = 120 \text{ lb/ft}^3$	$(1,923 \text{ kg/m}^3)$
$\beta = 78^\circ$	$\gamma_{\text{wall}} = 130 \text{ lb/ft}^3$	$(2,061 \text{ kg/m}^3)$
$K_a = 0.16$		

Load Factors:

Overturning Dead Loads	$G_{do} = 1.5$	Reflects level of knowledge/certainty of applied loads, ranges 1.5 - 2.0.
Resisting Dead Loads	$G_{dr} = 0.95$	Reflects level of knowledge/certainty of restraining loads, ranges 0.5 - 1.0.
Soil Friction Uncertainty Factor	$\phi_u = 1.0$	Recommended value of 1.0 for soils with tested friction angle values. Otherwise uncertainty factor ranges 0.6 - 1.0.
Structure Classification Factor	$\phi_n = 1.0$	Reflects effects of adjacent structures. If none then 1.0, otherwise 0.9 - 1.1.
Base Sliding Coefficient	$C_{ds} = 1.0$	Interaction certainty at base. Taken as 1.0 unless geogrid is present below first block course.

Design Friction Angle

$$\phi_d = \text{atan} [(\phi_u) (\tan \phi)] = 36^\circ$$

$$\phi_w = 0.666 \phi_d = 24^\circ$$

Horizontal Force Exerted by the soil:

$$F_h = 0.5 K_a [(G_{do}) (\gamma)] (H^2) (\cos) \phi_w$$

$$= 130 \text{ lb/ft} \quad (1.92 \text{ kN/m})$$

Weight of the Facing:

$$W_f = G_{dr} (\gamma_{\text{wall}}) (H) (t)$$

$$= 377 \text{ lb/ft} \quad (5.56 \text{ kN/m})$$

Sliding Failure

$$F_r = (\phi_n) (W_f) (\tan) (\phi_d) (C_{ds})$$

$$= 273 \text{ lb/ft} \quad (4.04 \text{ kN/m})$$

$$\text{SFS} = \frac{F_r}{F_h} = 2.1 > 1.0 \quad \text{ok}$$

Overturning Failure

$$M_r = W_f (t/2 + (0.5 H) \tan (90 - \beta))$$

$$= 309 \text{ ft-lb/ft} \quad (1.29 \text{ kN-m/m})$$

$$M_o = F_h (0.333 h)$$

$$= 136 \text{ ft-lb/ft} \quad (0.613 \text{ kN-m/m})$$

$$\text{SFO} = \frac{M_r}{M_o} = 2.3 > 1.0 \quad \text{ok}$$

Example: Limit States Design Analysis for a Coherent Gravity Wall

Given:

$\phi = 27^\circ$	$H = 9.52 \text{ ft}$	(2.9 m)
$i = 0^\circ$	$\gamma = 120 \text{ lb/ft}^3$	(1,923 kg/m ³)
$\beta = 78^\circ$	$\gamma_{\text{wall}} = 130 \text{ lb/ft}^3$	(2,061 kg/m ³)
$K_a = 0.26$	$L_t = 6.0 \text{ ft}$	(1.87 m)
	$L_s = 0.13 \text{ ft}$	(0.04 m)
	$t = 0.97 \text{ ft}$	(0.296 m)

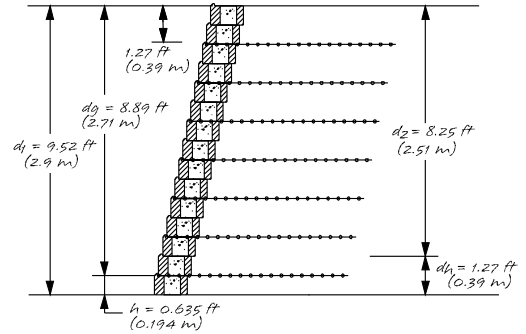

Overturning Dead Loads	$G_{do} = 1.5$	Reflects level of knowledge/certainty of applied loads, ranges 1.5 - 2.0.
Resisting Dead Loads	$G_{dr} = 0.95$	Reflects level of knowledge/certainty of restraining loads, ranges 0.5 - 1.0.
Soil Friction Uncertainty Factor	$\phi_u = 1.0$	Recommended value of 1.0 for soils with tested friction angle values. Otherwise uncertainty factor ranges 0.6 - 1.0.
Structure Classification Factor	$\phi_n = 1.0$	Reflects effects of adjacent structures. If none then 1.0, otherwise 0.9 - 1.1.
Base Sliding Coefficient	$C_{ds} = 1.0$	Interaction certainty at base. Taken as 1.0 unless geogrid is present below first block course.

Design Friction Angle

$$\phi_d = \text{atan}[(\phi_u)(\tan\phi)] = 27^\circ$$

$$\phi_w = 0.666 \phi_d = 18^\circ$$

External Stability

Horizontal Force Exerted by the soil:

$$F_h = 0.5 K_a [(G_{do})(\gamma)] (H^2) (\cos) \phi_w$$

$$= 2,017 \text{ lb/ft} \quad (29.6 \text{ kN/m})$$

Weight of the Facing:

$$W_f = (G_{dr})(\gamma_{\text{wall}})(H)(t)$$

$$= 1,140 \text{ lb/ft} \quad (16.8 \text{ kN/m})$$

Weight of Reinforced Soil Mass:

$$W_s = (G_{dr})(\gamma)(H)(L_t - t + L_s)$$

$$= 5,600 \text{ lb/ft} \quad (82.4 \text{ kN/m})$$

$$W_w = W_f + W_s = 6,740 \text{ lb/ft} \quad (99.2 \text{ kN/m})$$

Sliding Failure

$$F_r = (\phi_n)(W_w)(\tan)(\phi_d)(C_{ds})$$

$$= 3,434 \text{ lb/ft} \quad (50.5 \text{ kN/m})$$

$$\text{SFS} = \frac{F_r}{F_h} = 1.7 > 1.0 \quad \text{ok}$$

Overturning Failure

$$M_r = W_f(t/2 + (0.5 H) \tan(90 - \beta))$$

$$+ W_s[0.5(L_t - t + L_s) + t + (0.5 H) \tan(90 - \beta)]$$

$$= 27,250 \text{ ft-lb/ft} \quad (123 \text{ kN-m/m})$$

$$M_o = F_h(0.333 H)$$

$$= 6,394 \text{ ft-lb/ft} \quad (28.5 \text{ kN-m/m})$$

$$\text{SFO} = \frac{M_r}{M_o} = 4.3 > 1.0 \quad \text{ok}$$

Internal Stability

Partial Factors on Geogrid Strength:

Major geogrid manufacturers subject their materials to extensive testing to provide information for expected long term behavior. The resulting factors can vary greatly depending on geogrid material type and soil type. We suggest that specific data from a geogrid manufacturer be obtained over the give factors or ranges, which are typical values for most major manufacturers.

Service Life (in years): SL = 100 Duration of Test (in hours): TD = 100
 Geogrid Type: Polyester Backfill Type (fine or coarse): Fine

Range of Values

Product Uncertainty Factor:	ϕ_{up}	= 1.0	0.95 - 1.0
Creep Reduction Factor:	ϕ_{rc}	= 0.6	0.17 - 0.60
Extrapolation Uncertainty Factor:	ϕ_{ue}	= 0.95	0.50 - 1.0
Construction Damage Factor:	ϕ_{ri}	= 0.78	0.60 - 0.90
Thickness Reduction Factor:	ϕ_{rt}	= 1.0	0.90 - 1.0
Strength Reduction Factor:	ϕ_{rs}	= 0.90	0.50 - 0.90
Temperature Reduction Factor:	ϕ_{rst}	= 1.0	
Degradation Factor:	ϕ_d	= 0.80	

Partial Factors on Soil/Geogrid Interaction and Geogrid Connection:

Pullout Uncertainty Factor:	ϕ_{upull}	= 0.80	0.75 - 0.80
Coefficient of Pullout Resistance:	K_{pull}	= 0.70	
Connection Uncertainty Factor:	ϕ_{uconn}	= 0.75	

Geogrid Properties:

Ultimate Tensile Strength:

Grid Type A = $Tu_A = 35.04 \text{ kN/m}$

Design tensile Strength of Reinforcement:

$Td_A = (Tu_A) (\phi_{up}) [(\phi_{rc}) (\phi_{ue})] (\phi_{ri}) [(\phi_{rt}) (\phi_{rs}) (\phi_{rst})] (\phi_d) (\phi_n)$

$Td_A = 11.22 \text{ kN/m}$

Force on bottom grid layer:

$$F_{g1} = K_a \left[(Gdo) (\gamma) \frac{(d_1 + d_2)}{2} \right] dh$$

= 529 lb/ft (7.72 kN/m)

Pullout resistance (grid layer 1):

Geogrid beyond the line of maximum tension

$$L_{e1} = Lt - \frac{h}{\tan(45 + \phi_d/2)} - t + L_s$$

= 4.8 ft (1.45 m)

*Equation varies for two part maximum tension line.

Maximum Potential Restraining Force:

$$F_{gr1} = (2) (K_{pull}) (L_e) (\phi_{upull}) (Gdr) (dg) (\gamma) \tan(\phi_d) (\phi_n)$$

$$= 2,761 \text{ lb/ft (40.3 kN/m)}$$

Connection Strength:

Peak Connection Strength

$$F_{cs} = [acs + (\gamma_w) (dg) \tan(\lambda c)] (\phi_{uconn}) (\phi_n)$$

$$= 1,107 \text{ lb/ft (16.15 kN/m)}$$

$$SF_{conn} = \frac{F_{cs}}{(0.666) (F_g)} \quad 3.14 > 1.0 \text{ ok}$$

Connection Strengths

Connection Strength Intercept:

$$acs = 1,313 \text{ lb/ft (19.16 kN/m)}$$

Connection Strength Slope:

$$\lambda = 8^\circ$$

$$SF_{pullout} = \frac{F_{gr}}{F_g} = 5.2 > 1.0 \text{ ok}$$



**ALLAN
BLOCK**

allanblock.com

REFERENCES

- AB Spec Book, A Comprehensive Guide and Design Details for Segmental Retaining Walls, 2015
- Commercial Installation Manual for Allan Block Retaining Walls, 2014
- American Institute of Steel Construction Inc., "Manual of Steel Construction - Load and Resistance Factor Design", First Edition, 3rd Printing, March 1990
- Braja M. Das "Principles of Geotechnical Engineering" Third Edition, Chapter 10, 1994
- Columbia University in Cooperation with Allan Block Corporation and Huesker Geosynthetics. "Executive Summary - Seismic Testing - Geogrid Reinforced Soil Structures Faced with Segmental Retaining Wall Block", 2003
- Engineering Implications of the Relation between Static and Pseudo-Static Slope Stability Analysis, Robert Shukha, Rafael Baker and Dov Leshchinsky, (EJGE Paper 2005-616)
- Erickson Engineering Consulting Engineers - Joseph Arsenault and Brian Waters, PE
- Hoe I. Ling, et.al. Large-Scale Shaking Table tests on Modular-Block Reinforced Soil Retaining Walls; Tsukuba, Japan 2005
- Leshchinsky, D. and E.B. Perry. "A Design Procedure for Geotextile Reinforced Walls." Geotechnical Fabrics Report. St. Paul: July/August, 1987.
- Ling, H, etal: "Large Scale Shaking Table Tests on Modular-Block Reinforced Soil Retaining Walls", Journal of the Geotechnical and Geoenvironmental Engineering ASCE, April 2005
- Kliethermes, J., K. Buttry, E. McCullough, and R. Wetzel. "Modular Concrete Retaining Wall and Geogrid Performance and Laboratory Modeling." University of Wisconsin-Platteville, 1990.
- McKittrick, D.P. "Reinforced Earth: Application of Theory and Research to Practice." Reinforced Earth Technical Services, Report 79-1. Arlington, VA: The Reinforced Earth Company, 1978.
- Minnesota Department of Transportation. "Walls." Section 9-4.0 in Road Design Manual -- Part II. St. Paul: 1985.
- Peck, Ralph. "Earth Retaining Structures and Slopes." Chapter 13 in Soil Science, edited by T.W. Lambe and R.V. Whitman. New York: John Wiley & Sons, Inc., 1969.
- R. F. Craig, Chapman & Hall, "Soil Mechanics" Fifth Edition, 1992
- Robert Shukha, Rafael Baker and Dov Leshchinsky, "Engineering Implications of the Relation between Static and Pseudo-Static Slope Stability Analysis", EJGE Paper 2005-616
- Soil Strength and Slope Stability, J. Michael Duncan and Stephen G. Wright, Wiley Publications, 2005
- Slope Stability and Stabilization Methods, second edition, Lee W. Abramson, Thomas S. Lee, Sunil Sharma, Glenn M. Boyce, Wiley Publications, 2002
- Sowers, G.B., and G.F. Sowers. "Problems in Earth Pressure." Chapter 8 in Introductory Soil mechanics and Foundations. New York: The Macmillan Company, 1970.
- Victor Elias, PE, Barry Christopher, PhD, Ryan Berg PE, "Mechanically Stabilized Earth Walls and Reinforced Soil Slopes Design and Construction Guide Lines", FHWA NHI-00-043, March 2001
- U.S. Department of Transportation, Federal Highway Administration, "Limit Equilibrium Design Framework for MSE Structures with Extensible Reinforcement" FHWA-HIF-18-004, October 2016

Refer to the Best Practices for SRW Design and the AB Spec Book for details when applying the engineering principles outlined in this manual. Best Practices and the AB Spec Book addresses many common issues that should be detailed in the final approved design. For an expanded list of SRW design related references see the Best Practices for SRW Design document.

This technical specification manual will allow a wall designer to source and reference specific information for use in developing project documents. The information shown here is for use with Allan Block products only. Visit allanblock.com for the most current information.



allanblock.com

